

Surface Mount Reed Relays (2)

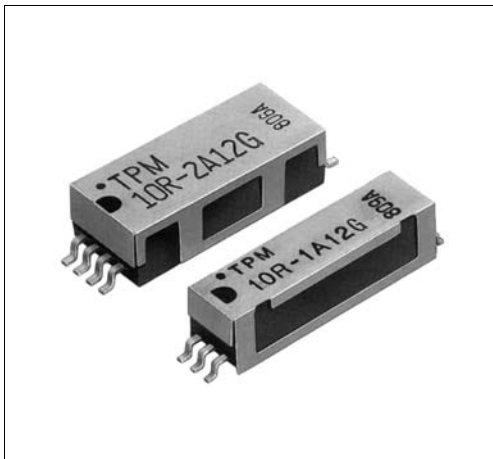

The 10 Series is the standard series for SMT 10 W contact rating. This product line comes in 1 Form A and 2 Form A arrangements. These relays provide the high-cycle support demanded by the ATE and communications.

- Standard SMT relays
- Impedance 50Ω
- Electric magnetic shield available
- UL Certified

Mechanical Dimensions

All dimensions are measured in inches (millimeters).

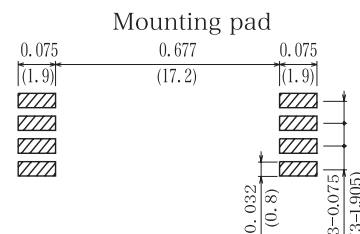
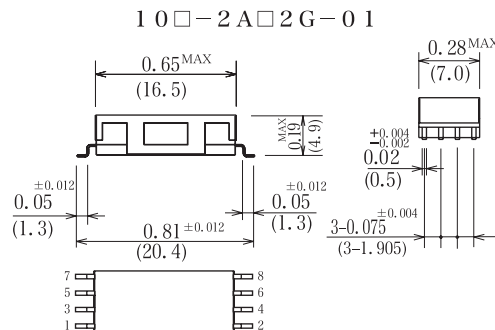
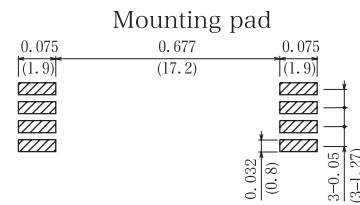
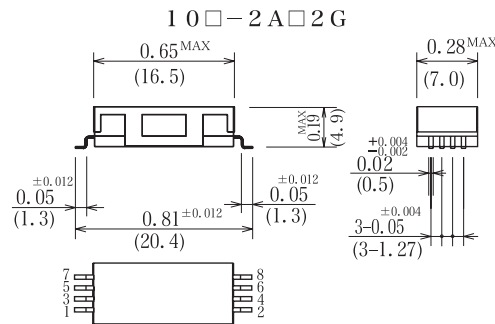
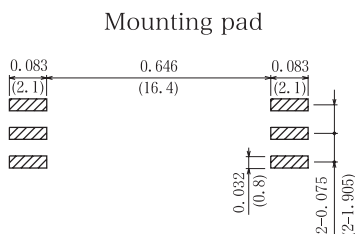
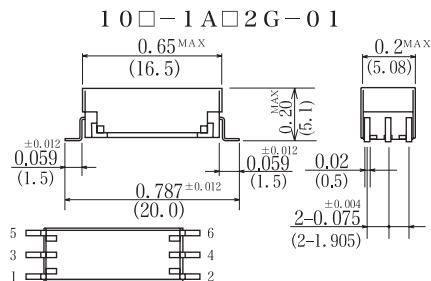
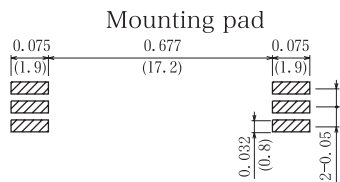
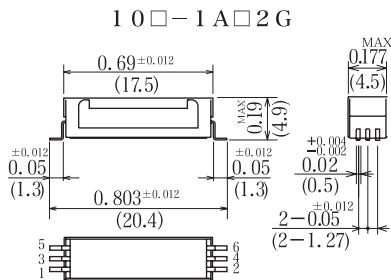
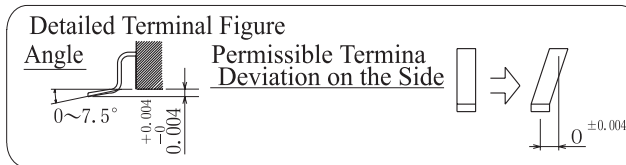

As for 10D-1A and 10R-1A type relays, the tape-and-reel packing is also available, Refer to page 44, 45



10D, 10R Series			50Ω Coaxial	50Ω Coaxial	50Ω Coaxial	50Ω Coaxial
			Model Number	Model Number	Model Number	Model Number
Parameters	Test Condition	Units	10D-1A□□-□□	10R-1A□□-□□	10D-2A□□-□□	10R-2A□□-□□
			1 Form A	1 Form A	2 Form A	2 Form A
Coil Specifications						
Nominal coil voltage		VDC	5	12	5	12
Coil resistance	±10%at20°C	Ω	160	600	140	600
Operating voltage	15°C~35°C	VDC Max	3.6	9.6	3.6	9.6
Release voltage	15°C~35°C	VDC Min	0.8	1.2	0.8	1.2
Contact Ratings						
Switching voltage	Max. DC/Peak AC resistance	Volts	100	200	100	200
Switching current	Max. DC/Peak AC resistance	Amps	0.5	0.5	0.5	0.5
Carry current	Max. DC/Peak AC resistance	Amps	1.0	1.0	1.0	1.0
Contact rating	Max. DC/Peak AC resistance	Watts	10	10	10	10
Life expectancy	1V. 10mA	×10 ⁶ cycles	1000	1500	1000	1500
Contact resistance	Maximum initial	mΩ	150	150	150	150
Contact resistance stability	Maximum initial	mΩ	5.0	5.0	5.0	5.0
Relay Specifications						
Insulation resistance	Between all isolated pins at 100V 20°C 40%RH	Ω	10 ¹¹		10 ¹¹	
Capacitance		pF-Max				
Across open contacts	Shield guarding		0.2		0.2	
Contact to Shield	Contacts open, Shield floating		1.7		1.8	
Open contact to coil	Shield guarding		0.8		0.8	
Dielectric strength	Between contacts	VDC	250		250	
	Contacts to shield		250		250	
Operating time (Including. bounce)	At nominal coil voltage, 100Hz Square wave	msec	0.5		0.5	
Release time	Diode suppression	msec	0.5		0.5	
Environmental Ratings		Schematics Top view	10□-1A□□	10□-1A□□-01	10□-2A□□	10□-2A□□-01
Measurement reference conditons Temp. : 15°C~35°C Humidity : 25%~85%RH Atmospheric pressure : 860~1060hPa Storage temp. : -40°C~+80°C Operating temp. : -20°C~+60°C The operating and Release Voltage and the coil resistance are specified at 20°C. These values change approximately 0.4%/°C change in the ambient temperature. Vibration : 20Gs to 2000Hz Shock : 50Gs						

10R Series

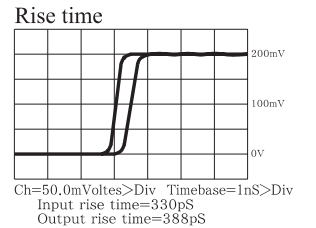
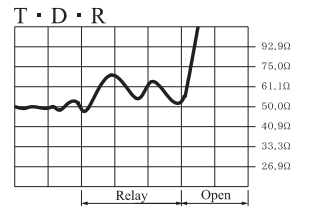
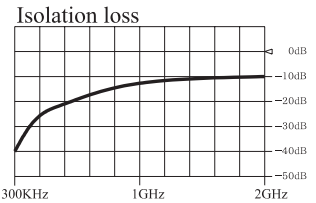
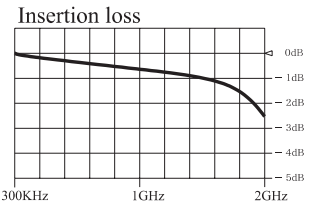

Notes :

- Values are specified with a resistive load being applied. A contact protective circuit is required for C and L type loads.
 - The values for the operating time and release time however, are when the rated coil voltage is applied and a clamp diode is attached.
 - Surface mount component processing temperature:446°F (230°C) max. for 10 seconds dwell time. Temperature is measured at leads where they exit the package.
- ※ 1 Please contact sales department the availabilities of terminal style J-Lead.
 ※ 2 Please pay attention to the difference of Circuit between “10□-□A□□” and “10□-□A□□-01”

ORDERING CODE

1 0 □ - □ A □ 2 □ - □ □
 (1) (2) (3) (4) (5)

Example 10R-1A12G Represents Series 10R with 1Form A, Dry Reed (Ruthenium), Coil Voltage 5V, Electrostatic Shield and Terminal Style Gull-Wing.

(1) Reed Switch Type D-Dry Reed (Rhodium) R-Dry Reed (Ruthenium)	(4) Terminal Style G-Gull- Wing J-J-Lead ※1
(2) Number of capsule 1-1capsule 2-2capsules	(5) Special Code Example 01-0.075 inch(1.905mm)itches ※2
(3) Coil Voltage 1-5VDC 2-12VDC	

Packing Specification

All dimensions are measured in inches (millimeters)

Tape shape & dimensions

10 □ -1A TYPE

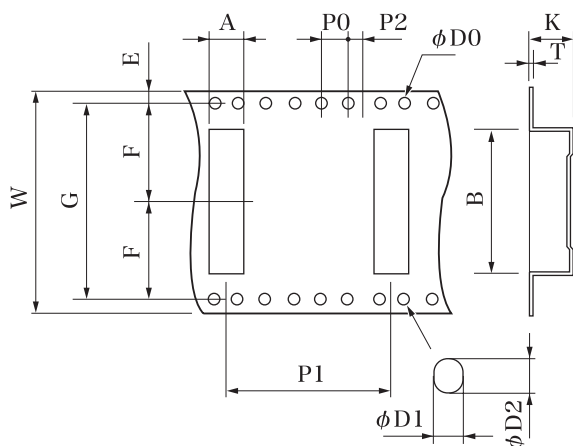

1D-14 □, 1D-12 □ TYPE

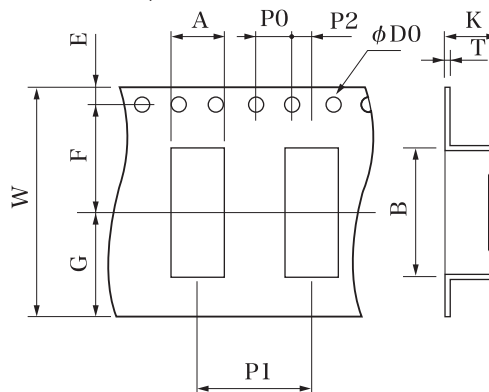

PKG Type	W	A	B	E	F	G	P ₀
10 □ -1A Type	1.26 ^{+0.012} (32.0)	0.2 ^{+0.004} (5.0)	0.82 ^{+0.006} (20.9)	0.07 ^{+0.004} (1.8)	0.56 ^{+0.004} (14.2)	1.118 ^{+0.012} (28.4)	0.157 ^{+0.004} (4.0)
1D-14J Type	0.94 ^{+0.012} (24.0)	0.2 ^{+0.004} (5.0)	0.43 ^{+0.005} (10.8)	0.069 ^{+0.004} (1.75)	0.45 ^{+0.004} (11.5)	0.42 (10.75)	0.157 ^{+0.004} (4.0)
1D-14G Type 1D-12G Type	0.94 ^{+0.012} (24.0)	0.2 ^{+0.004} (5.0)	0.52 ^{+0.006} (13.2)	0.069 ^{+0.004} (1.75)	0.45 ^{+0.004} (11.5)	0.42 (10.75)	0.157 ^{+0.004} (4.0)

PKG Type	P ₁	P ₂	D ₀	D ₁	D ₂	K	T
10 □ -1A Type	0.94 ^{+0.004} (24.0)	0.08 ^{+0.004} (2.0)	0.059 ^{+0.004} (1.5)	0.06 (1.5)	0.07 (1.7)	0.22 ^{+0.012} (5.6)	0.016 (0.4)
1D-14J Type	0.47 ^{+0.004} (12.0)	0.08 ^{+0.004} (2.0)	0.059 ^{+0.004} (1.5)	—	—	0.216 ^{+0.012} (5.5)	0.016 (0.4)
1D-14G Type 1D-12G Type	0.47 ^{+0.004} (12.0)	0.08 ^{+0.004} (2.0)	0.059 ^{+0.004} (1.5)	—	—	0.21 ^{+0.012} (5.35)	0.016 (0.4)

Device mounting directions

10 □ -1A □ 2G-R1

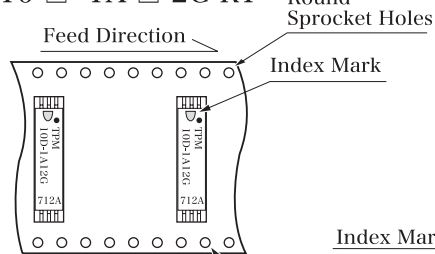

10 □ -1A □ 2G-R2

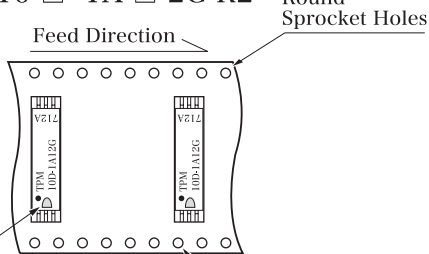

1D-14 □ -R1
1D-12 □ -R1

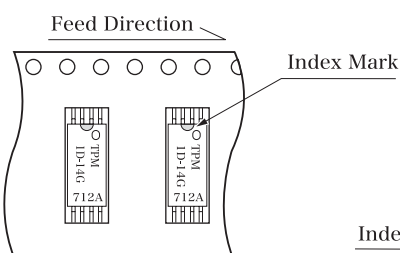

1D-14 □ -R2
1D-12 □ -R2

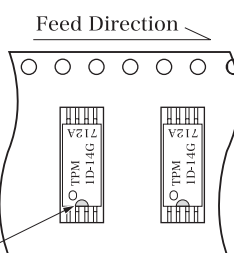

Two types of packaging (R1 & R2) are available. At the time of order, please specify the type you choose (R1 or R2), following the mention of the relay type. The packaging type (R1 or R2) is not to be imprinted on the product. Please be careful about the difference in arrangement direction between them.

All dimensions are measured in inches (millimeters)

Reel shape & dimensions

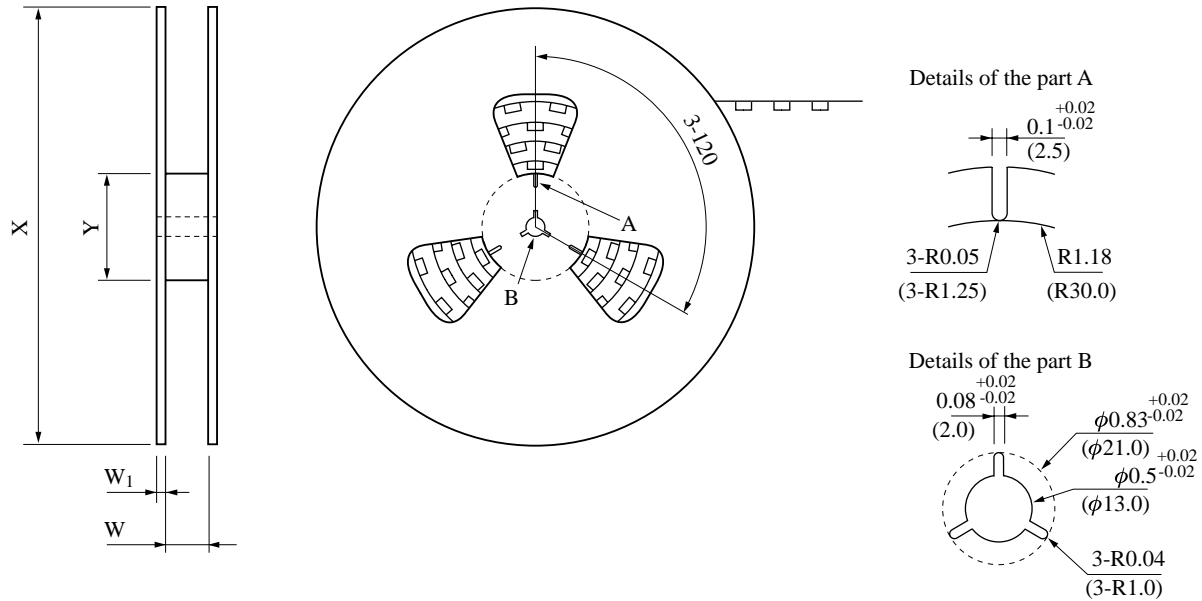

PKG Type	X	Y	W	W ₁	Quantity
10□-1A Type	12.6 ^{+0.079} (320)	3.15 ^{+0.02} (80)	1.28 ^{+0.079} (32.5)	0.11 (2.8)	500
1D-14□ 1D-12□ Type	12.6 ^{+0.079} (320)	3.15 ^{+0.02} (80)	1.0 ^{+0.035} _{-0.043} (25.4)	0.12 (3.0)	1000

(for 10 □ -1A type)

(for 1D -14 □, 1D-12 □ type)

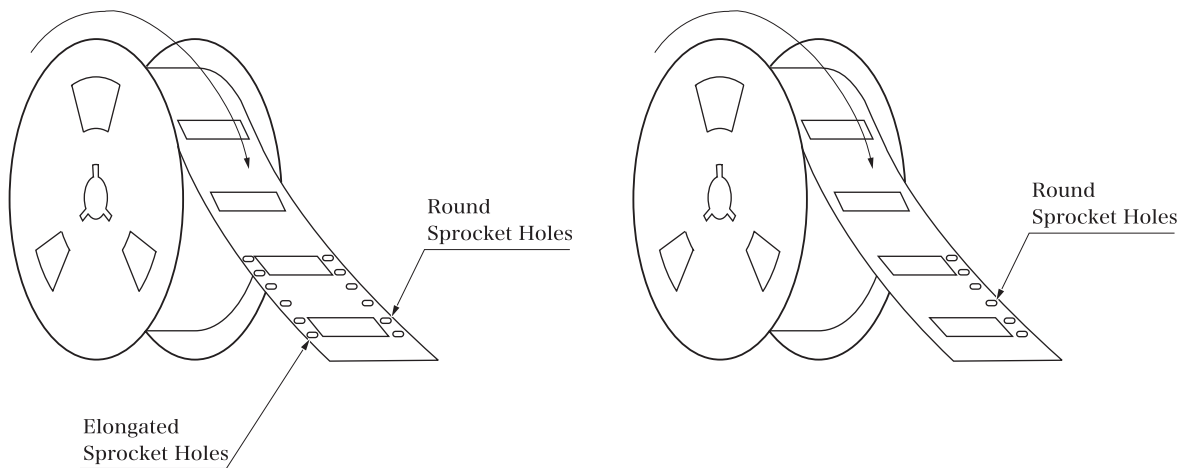

Packaging conforms to EIA standard EIA-481-2 or EIA-481-3.

Please let our Sales Department know when the packing with tape-and-reel for 3D type and 17□ type will be needed.