

Performance Parameters

1MDL06-035-xxAN25

Type	ΔT_{max} K	Q_{max} W	I_{max} A	U_{max} V	AC R Ohm	H mm
1MDL06-035-xxAN25 (N=35)						
1MDL06-035-03AN25	70	14.41	5.4	4.4	0.62	0.9
1MDL06-035-05AN25	72	8.98	3.3		1.01	1.1
1MDL06-035-07AN25	73	6.52	2.4		1.39	1.3
1MDL06-035-09AN25	73	5.11	1.9		1.77	1.5
1MDL06-035-12AN25	73	3.87	1.4		2.35	1.8
1MDL06-035-15AN25	74	3.12	1.1		2.92	2.1

Performance data are given for 300K, vacuum

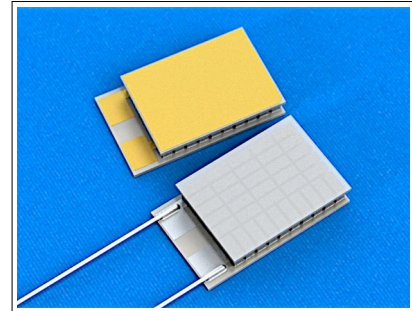

Dimensions

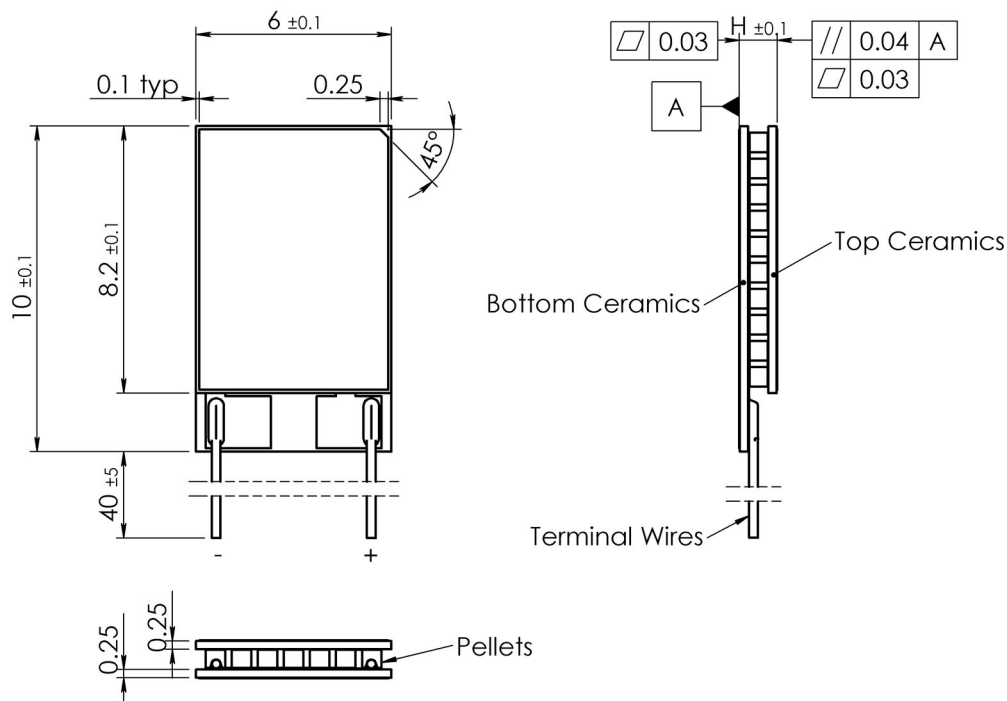

Manufacturing options

A. TEC Assembly:

- * 1. Solder SnSb ($T_{melt}=230^\circ\text{C}$)
- 2. Solder AuSn ($T_{melt}=280^\circ\text{C}$)

B. Ceramics:

- 1. Pure Al_2O_3 (100%)
- 2. Alumina (Al_2O_3 - 96%)

- * 3. Aluminum Nitride (AlN)

* - used by default

C. Ceramics Surface Options:

- 1. Blank ceramics (not metallized)
- 2. Metallized (Au plating)
- 3. Metallized and pre-tinned with:
 - 3.1 Solder 117 (In-Sn, $T_{melt} = 117^\circ\text{C}$)
 - 3.2 Solder 138 (Sn-Bi, $T_{melt} = 138^\circ\text{C}$)
 - 3.3 Solder 143 (In-Ag, $T_{melt} = 143^\circ\text{C}$)
 - 3.4 Solder 157 (In, $T_{melt} = 157^\circ\text{C}$)
 - 3.5 Solder 183 (Pb-Sn, $T_{melt} = 183^\circ\text{C}$)
 - 3.6 Optional (specified by Customer)

D. Thermistor (optional)

Can be mounted to cold side ceramics edge. Calibration is available by request.

E. Terminal contacts

- 1. Blank, tinned Copper
- 2. Insulated Wires
- 3. Insulated, color coded

Performance Data

1MDL06-035-03AN25

@ 27°C, Vacuum	ΔT_{max} K	Q_{max} W	I_{max} A	U_{max} V
1MDL06-035-03AN25	70	14.41	5.4	4.4

@50°C, N2	ΔT_{max} K	Q_{max} W	I_{max} A	U_{max} V
1MDL06-035-03AN25	76	15.78	5.4	4.9

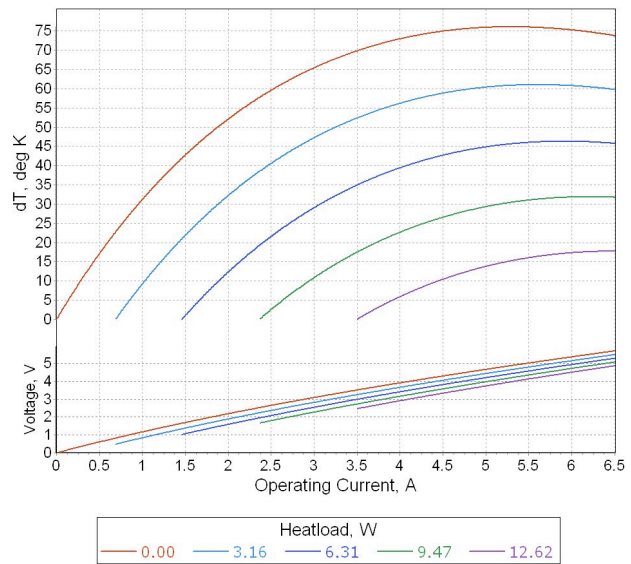
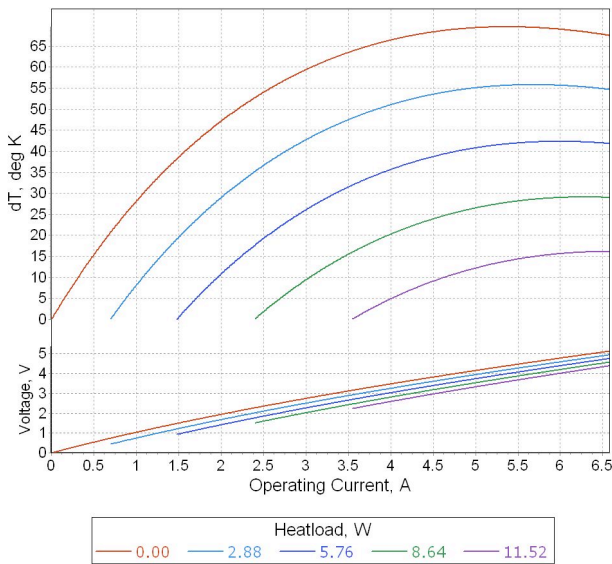

Note: Performance data is specified at optimal conditions (TEC hot side is stabilized at ambient temperature). Heatsink thermal resistance is not included into estimations. Use TECCad Software for estimations under different conditions.

Performance Data

1MDL06-035-05AN25

@ 27°C, Vacuum	ΔT_{max} K	Q_{max} W	I_{max} A	U_{max} V
1MDL06-035-05AN25	72	8.98	3.3	4.4

@50°C, N2	ΔT_{max} K	Q_{max} W	I_{max} A	U_{max} V
1MDL06-035-05AN25	78	9.81	3.3	4.9

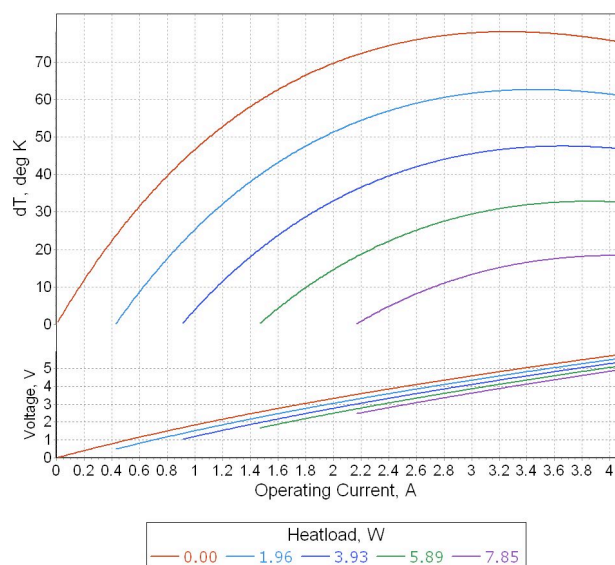
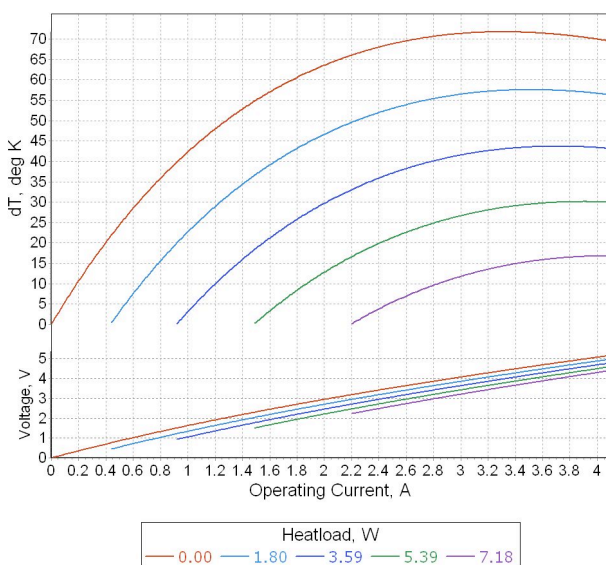

Note: Performance data is specified at optimal conditions (TEC hot side is stabilized at ambient temperature). Heatsink thermal resistance is not included into estimations. Use TECCad Software for estimations under different conditions.

Performance Data

1MDL06-035-07AN25

@ 27°C, Vacuum	ΔT_{max} K	Q_{max} W	I_{max} A	U_{max} V
1MDL06-035-07AN25	73	6.52	2.4	4.4

@50°C, N2	ΔT_{max} K	Q_{max} W	I_{max} A	U_{max} V
1MDL06-035-07AN25	79	7.13	2.4	4.9

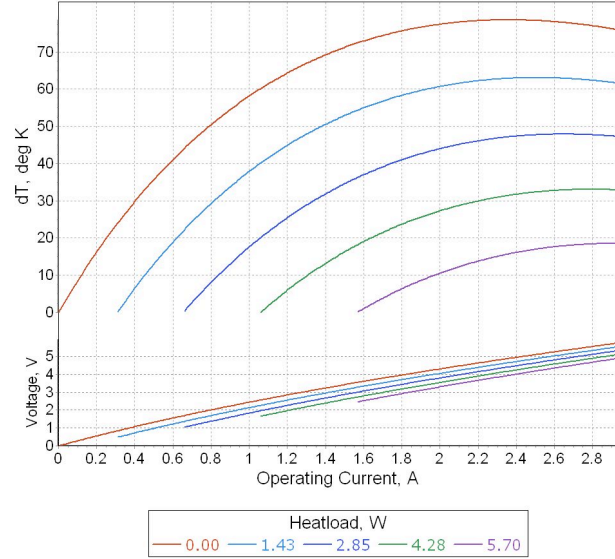
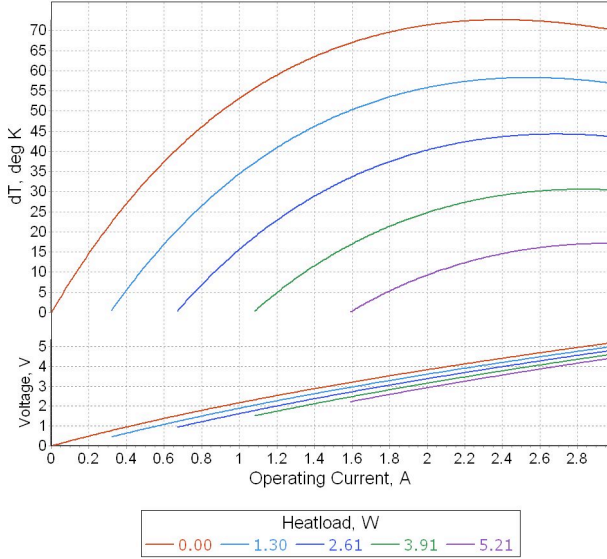

Note: Performance data is specified at optimal conditions (TEC hot side is stabilized at ambient temperature). Heatsink thermal resistance is not included into estimations. Use TECCad Software for estimations under different conditions.

Performance Data

1MDL06-035-09AN25

@ 27°C, Vacuum	ΔT_{max} K	Q_{max} W	I_{max} A	U_{max} V
1MDL06-035-09AN25	73	5.11	1.9	4.4

@50°C, N2	ΔT_{max} K	Q_{max} W	I_{max} A	U_{max} V
1MDL06-035-09AN25	79	5.59	1.9	4.9

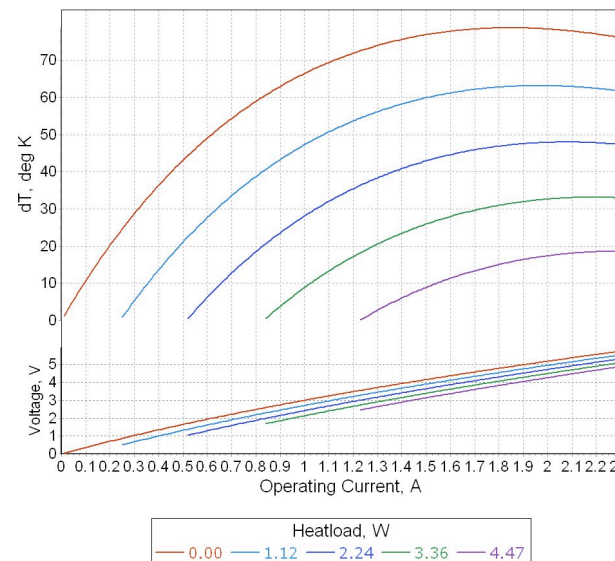
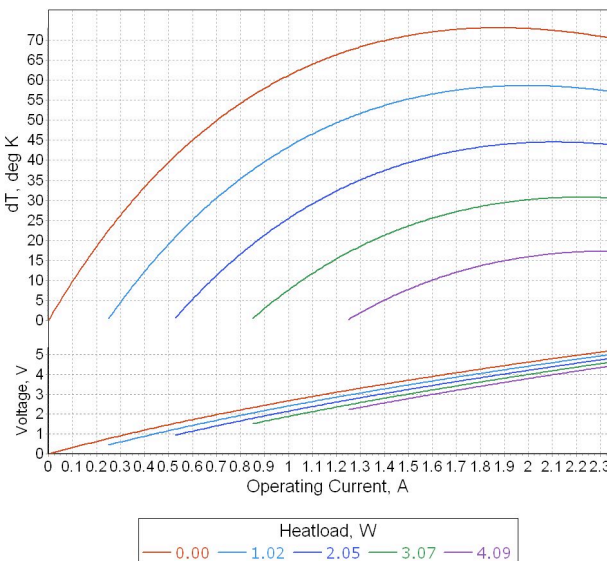

Note: Performance data is specified at optimal conditions (TEC hot side is stabilized at ambient temperature). Heatsink thermal resistance is not included into estimations. Use TECCad Software for estimations under different conditions.

Performance Data

1MDL06-035-12AN25

@ 27°C, Vacuum	ΔT_{max} K	Q_{max} W	I_{max} A	U_{max} V
1MDL06-035-12AN25	73	3.87	1.4	4.4

@50°C, N2	ΔT_{max} K	Q_{max} W	I_{max} A	U_{max} V
1MDL06-035-12AN25	79	4.23	1.4	4.9

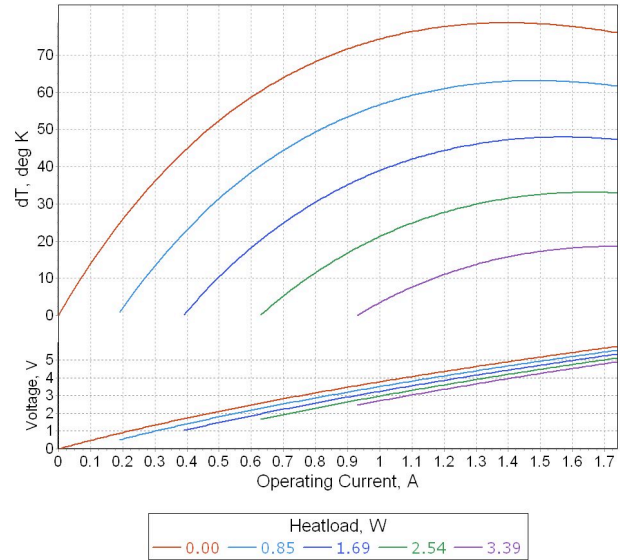
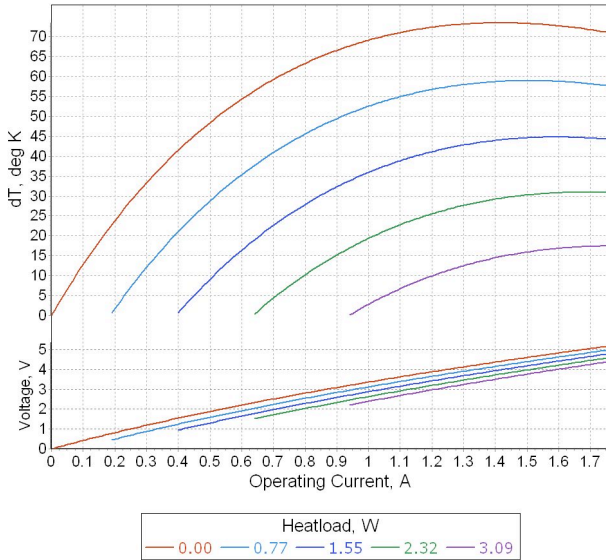

Note: Performance data is specified at optimal conditions (TEC hot side is stabilized at ambient temperature). Heatsink thermal resistance is not included into estimations. Use TECCad Software for estimations under different conditions.

Performance Data

1MDL06-035-15AN25

@ 27°C, Vacuum	ΔT_{max} K	Q_{max} W	I_{max} A	U_{max} V
1MDL06-035-15AN25	74	3.12	1.1	4.4

@50°C, N2	ΔT_{max} K	Q_{max} W	I_{max} A	U_{max} V
1MDL06-035-15AN25	78	3.40	1.1	4.9

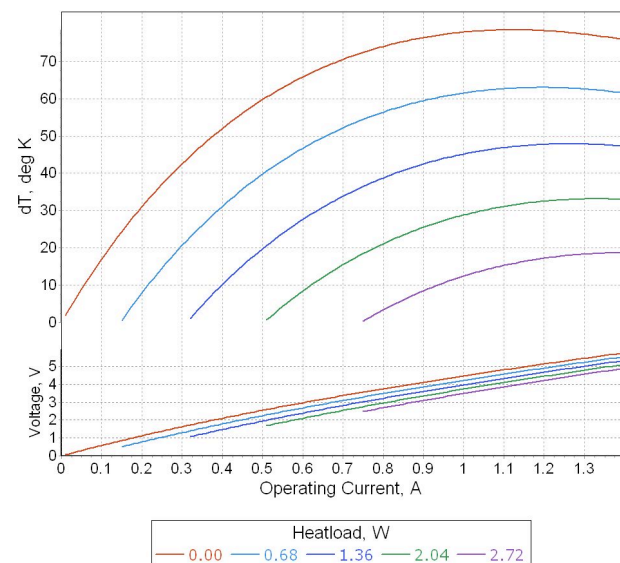
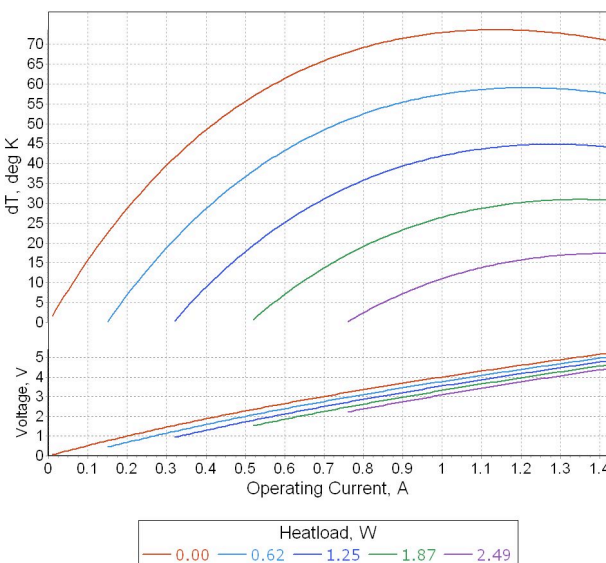

Note: Performance data is specified at optimal conditions (TEC hot side is stabilized at ambient temperature). Heatsink thermal resistance is not included into estimations. Use TECCad Software for estimations under different conditions.

Additional Options

TEC Polarity

TEC Polarity can be modified by request. The specified polarity in this datasheet is typical. It can be reversed in accordance to Customer application requirements.

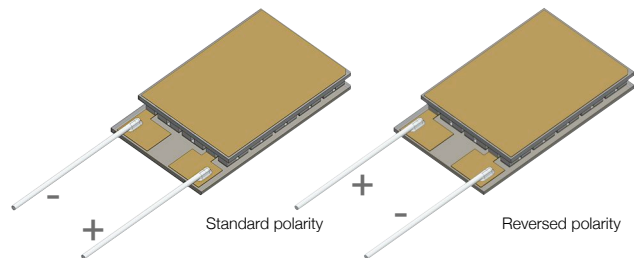

Terminal Wires Options

The standard solution is with terminal wires. TEC can be modified for WB process by request. In this case terminal wires are not mounted, TEC has Au plated WB pads.

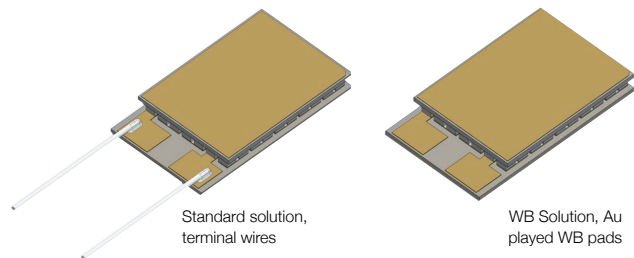

Optimization for WB process

In case of WB optimization, the standard WB solution is with WB pads (no posts) by default. WB posts are available by request. The dimensions of WB posts can be modified and optimized for Customers application. WB posts are made of Copper, Au plated.

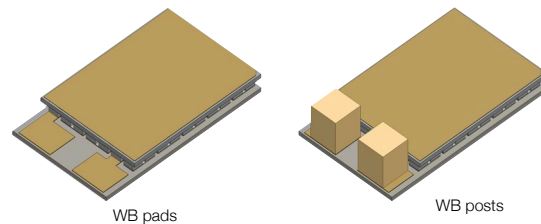

Customized Au Patterns

Customized Au patterns on thermoelectric cooler cold side are available by request. Selective Pre-tinning over pattern is also available. Please, contact RMT Ltd for additional information about customized Au patterns requirements.

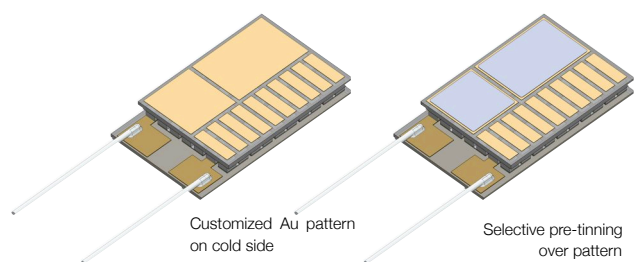

TEC Height modification

Standard TEC height can be modified without performance changes by using ceramics of different thickness. Standard thermoelectric cooler height (specified in this datasheet) can be increased in a range +0.5..+1.5 mm by request.

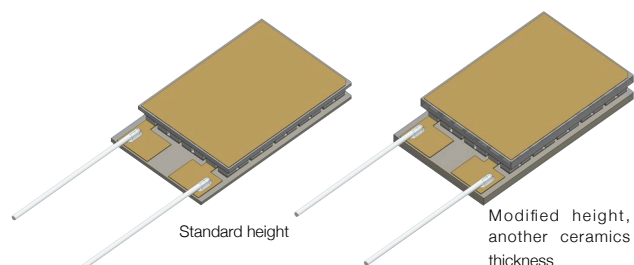

Thermoelectric Cooler Overview

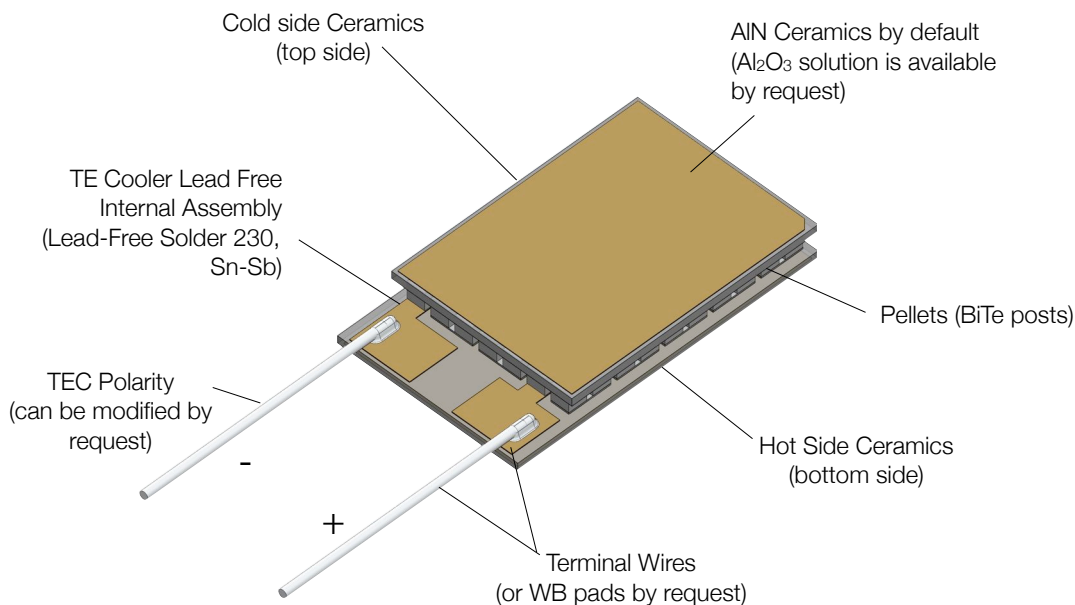

Application Tips

- | | |
|---|---|
| <ol style="list-style-type: none"> 1. Never heat TE module more than 200°C (TEC assembled at 230°C). 2. Never use TE module without an attached heat sink at hot (bottom) side. | <ol style="list-style-type: none"> 1. Connect TE module to DC power supply according to polarity. 2. Do not apply DC current higher than I_{max}. |
|---|---|

Installation

1. **Mechanical Mounting.** TEC is placed between two heat exchangers. This construction is fixed by screws or in another mechanical way. It is suitable for large modules (with dimensions 30x30mm and larger). Miniature types require other assembling methods in most cases.
1. **Soldering.** This method is suitable for a TE module with metallized outside surfaces. RMT provides this option and also makes pre-tinning for TE modules.
2. **Gluing.** It is an up-to-date method that is used by many customers due to availability of glues with good thermoconductive properties. A glue is usually based on some epoxy compound filled with some thermoconductive material such as graphite or diamond powders, silver, SiN and others. The application of a specific type depends on application features and the type of a TE module.

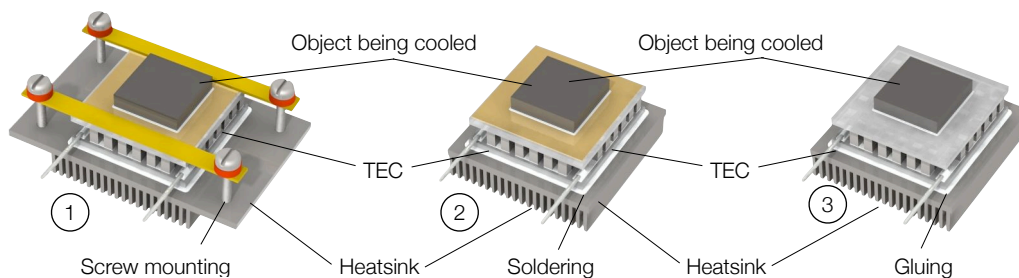

Contacts

RMT Ltd. Headquarters

Warshavskoe sh. 46, 115230, Moscow

Russia

Phone: +7-499-678-2082

Fax: +7-499-678-2083

Web: www.rmtltd.ru

Email: info@rmtltd.ru

EUROPE/USA - TEC Microsystems GmbH

Schwarzschildstrasse 3, 12489 Berlin

Germany

Tel. +49 30 6789 3314

Fax+49 30 6789 3315

Web: www.tec-microsystems.com

Email: info@tec-microsystems.com

CHINA - ProTEC Ltd.

深圳市南山区登良路恒裕中心B座207

电话：+86-755-61596066

传真：+86-755-61596036

邮编：518054

Web: www.protecltd.com

Email: info@protecltd.com

Legal Notice

All logos, images, trademarks and product names (collectively Materials) are proprietary to RMT Ltd and/ or any of its affiliates, or subsidiaries, or other respective owners that have granted RMT Ltd the permission and/or license to use such Materials. All images are provided by RMT Ltd. and are subjects of copyright protection.

RMT Ltd, TEC Microsystems GmbH and ProTEC Ltd do not grant a copyright license (express or implied) to the Recipient, except that Recipient may reproduce the logos, images and text materials in this press-release without any alteration for non-promotional or editorial purposes only with a written note about materials owner.

Copyright protection warning

Graphic materials and text from this datasheet may not be used commercially without a prior response in writing on company letterhead and signed by RMT Ltd authority. Thank you for respecting the intellectual property rights protected by the International Copyright laws.

Warning: All datasheet images contain RMT Ltd hidden watermark for the immediate proof of their origin.



RMT Image



Hidden Watermark