

TAS5548-5558EVM

This manual describes the operation of the TAS5548(-5558) EVM (EVM), for evaluation of the features of the TAS5548 PWM digital audio processor. The TAS5548 EVM is also used for TAS5558. The functions and features in the TAS5548 are the same as TAS5558. The evaluation module is called EVM and the device name reference is TAS5548 for the remainder of this document. The main contents of this document are:

- Details on how to properly connect this EVM and the details of the EVM
- Details on how to install and use the GUI to program the EVM
- Quick-Start Guide for the common modes in which the EVM can be used
- Details on how to use the audio processing features like EQ and DRC

Contents

1	Overview	2
	1.1 TAS5548EVM Features	2
2	EVM Setup and Software Installation	3
	2.1 EVM Setup	3
	2.2 Software Installation	4
3	Software Quick-Start Guide	4
4	Using the EVM Software	5
	4.1 Main Tab	5
	4.2 Block Diagram Tab	6
	4.3 Process Flow Tab	6
	4.4 Direct I ² C™ Access Tab	7
	4.5 TAS5548 Registers Tab	7
5	Board Layouts, Schematic, and Bill of Materials	8
	5.1 TAS5548EVM Board Layouts	8
	5.2 TAS5548EVM Schematic	9
	5.3 TAS5548-5558EVM Bill of Materials	10

List of Figures

1	TAS5548EVM Printed-Circuit Board	2
2	Complete EVM Signal Path.....	2
3	General Connection Picture	3
4	Process Flow for TAS5548 GUI.....	4
5	Main Tab	5
6	Process Flow Tab.....	6
7	Direct I ² C Access.....	7
8	Registers Tab (Selecting Biquad GUI)	7
9	TAS5548EVM Top Composite Assembly.....	8
10	TAS5548EVM Top Copper Assembly.....	8
11	TAS5548EVM Schematic.....	9

1 Overview

The EVM demonstrates the TAS5548 device from Texas Instruments. The TAS5548 is an 8-channel audio processor with ASRC and PWM output. This EVM has two outputs (Left and Right channels) via 3.5-mm headphone jack. For detailed information about the TAS5548 device, review the device data sheet ([SLES270](#)).

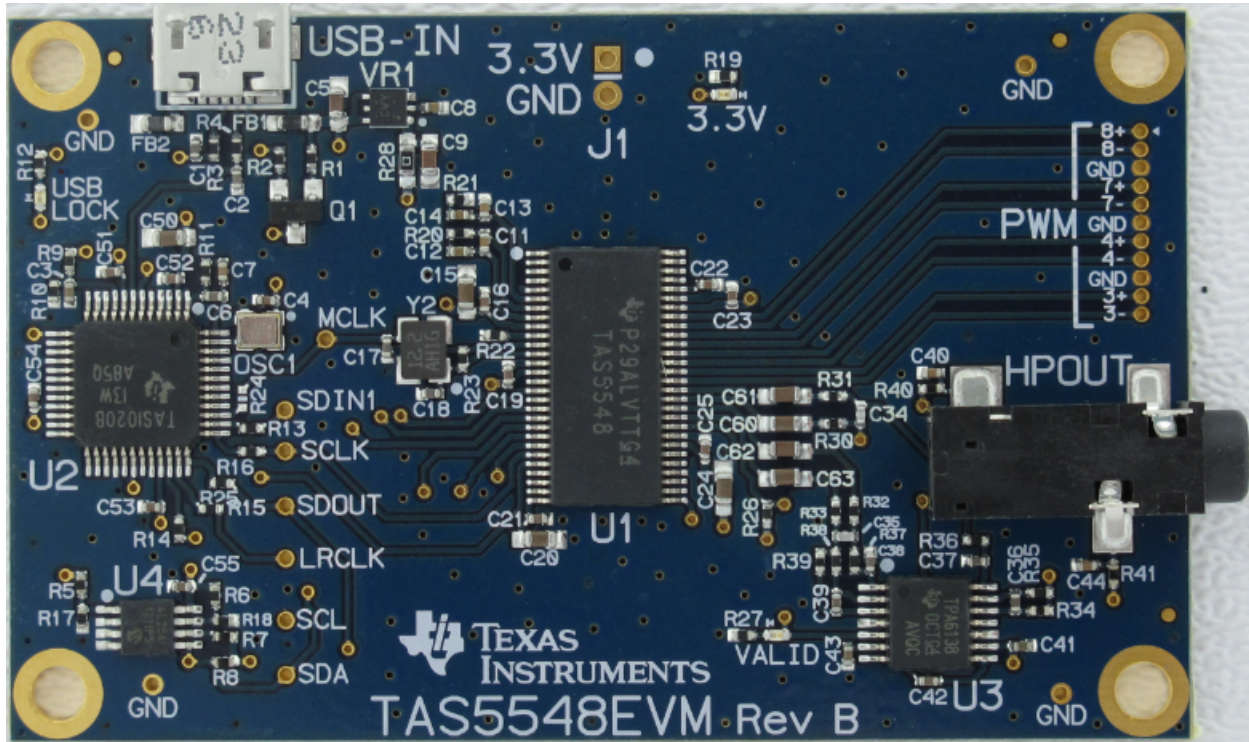

Figure 1. TAS5548EVM Printed-Circuit Board

The EVM, together with other TI components on this board, is a 2.0-channel digital audio processor system. The digital input (I2S) comes from USB port via the TAS1020B. The 2-channel outputs go to the TPA6138A2, headphones amplifier.

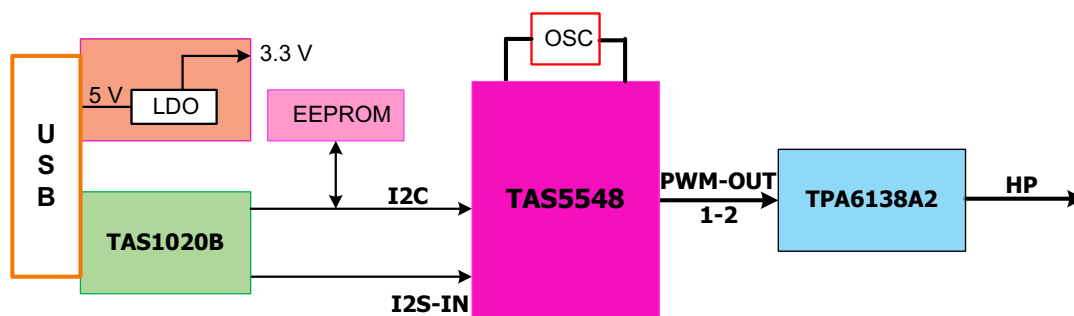

Figure 2. Complete EVM Signal Path

1.1 TAS5548EVM Features

- USB powered (~320 mA)
- Audio streams from host PC
- Small form factor for software development – portable
- No jumpers or extensive setup time

2 EVM Setup and Software Installation

This section describes the EVM setup and software installation.

2.1 EVM Setup

USB Micro-
Controller

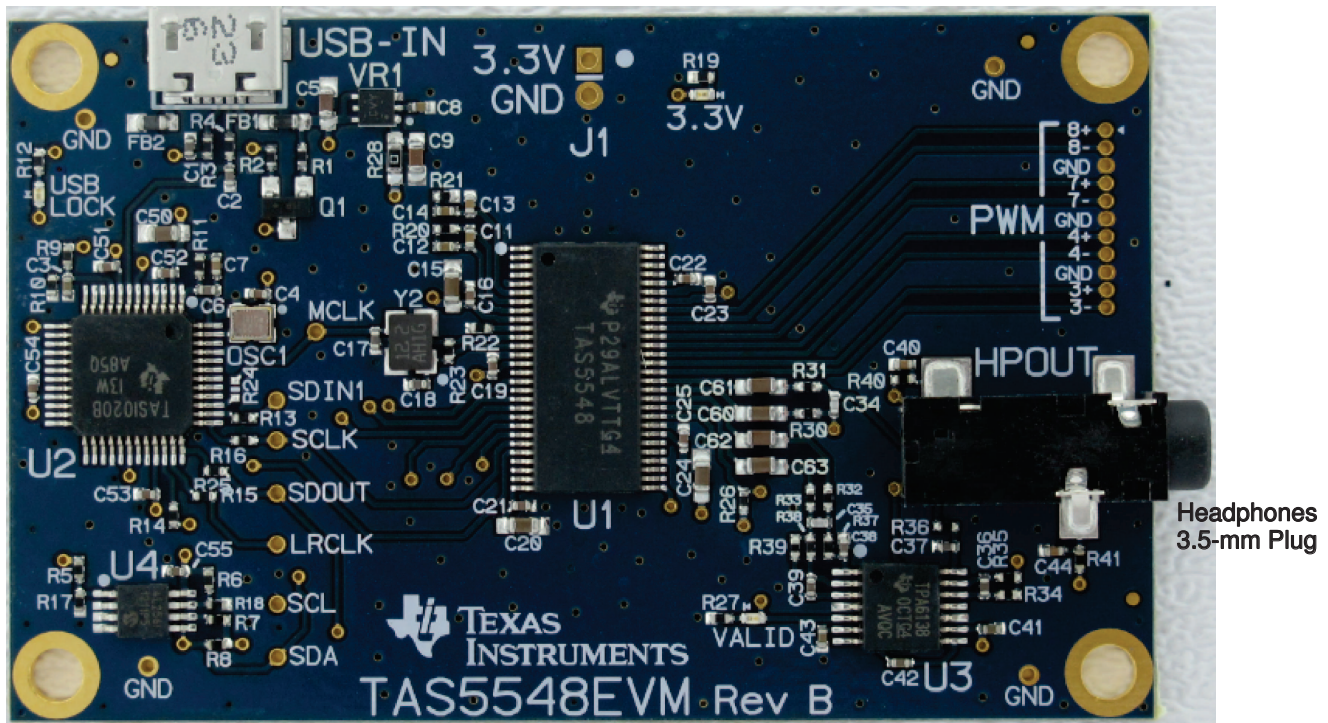

Figure 3. General Connection Picture

The following are the basic hardware for the initial EVM power up:

- Desktop or laptop PC running either Windows® XP or Windows 7
- Headphones set with 3.5-mm plug
- USB micro type B cable

When the USB cable is plugged in from the PC to the EVM, 3.3-V LED (green) and USB Lock LED (blue) are illuminated. These indicators show that the EVM is working correctly.

2.2 Software Installation

Download the ControlConsole GUI from the TI Web site. The TI Web site always has the latest release and any updates to versions of the GUI.

Execute the GUI install program, Setup_ControlConsole_Main_vxx_revxx.exe. Once the program is installed, the program group and shortcut icon is created in Start → Program → Texas Instruments Inc → ControlConsole → Choose Target. When the GUI comes up, select TAS5548 as shown in [Figure 4](#).



Figure 4. Process Flow for TAS5548 GUI

3 Software Quick-Start Guide

The EVM is initialized upon ControlConsole GUI startup. Audio is streaming to the headphones if Window Media (or similar program) is playing and mini-USB EVM is selected in the sound playback properties. The following indicators show both ControlConsole GUI and EVM are operating correctly:

- On the EVM, the VALID LED (green) is on
- On the ControlConsole GUI, both green LEDs on the bottom left corner are on

4 Using the EVM Software

4.1 Main Tab

Figure 5 illustrates the main tab () when the GUI starts up. Clicking the TAS5548 icon directs you to the device block diagram.

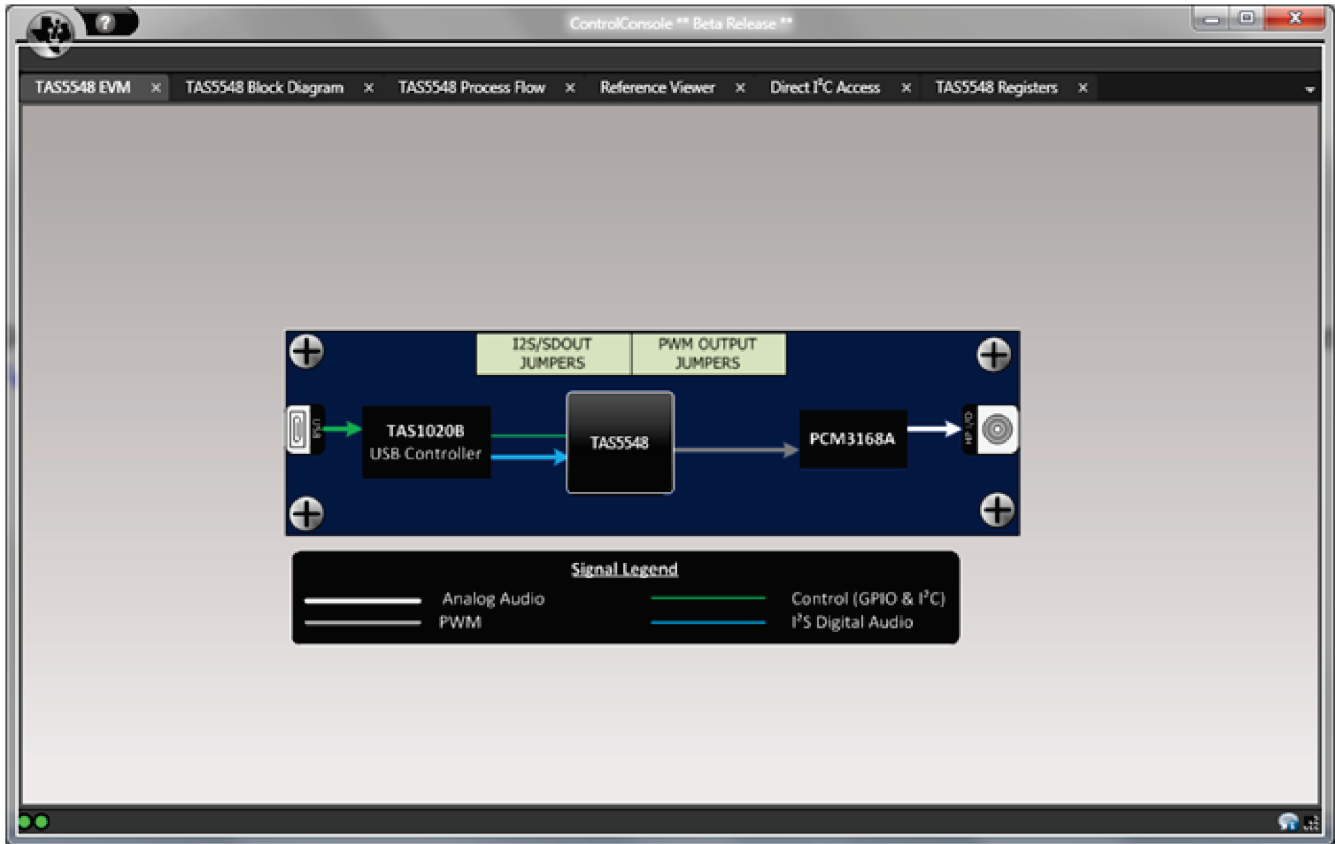

Figure 5. Main Tab

4.2 Block Diagram Tab

This tab shows major blocks of the device. To control the device, click on the digital audio processor (DAP) bringing up the TAS5548 process flow tab.

4.3 Process Flow Tab

The process flow tab, [Figure 6](#), controls the TAS5548 main functions: EQ, DRC, input and output mixing, tone, and volume.

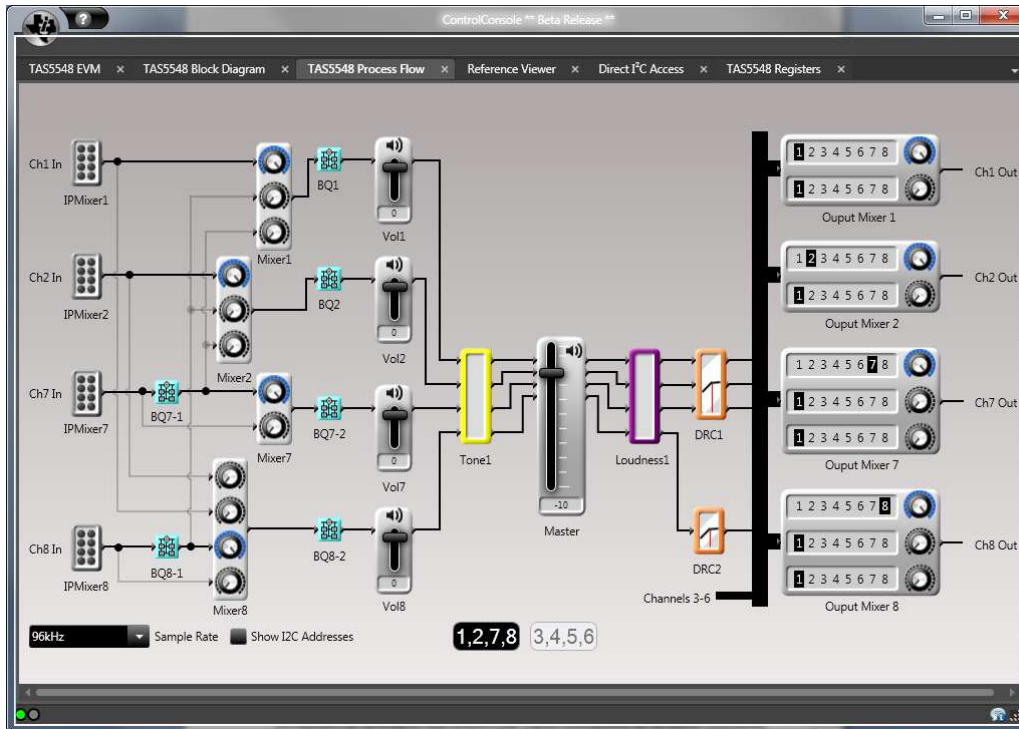

Figure 6. Process Flow Tab

4.4 Direct I²C™ Access Tab

Reading and writing I²C registers is performed on the tab illustrated in Figure 7.

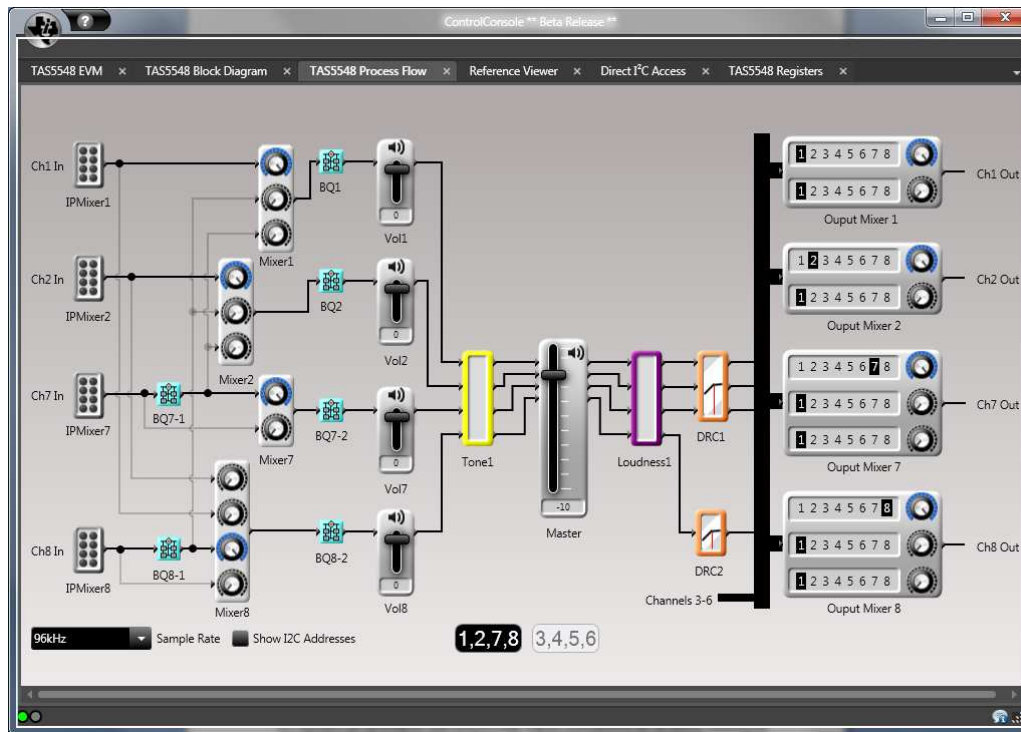

Figure 7. Direct I²C Access

4.5 TAS5548 Registers Tab

The TAS5548 registers tab, illustrated in Figure 8, shows the current I²C register values (hexadecimal and decimal).

Sub Address	Register Name	Dec Value	Hex Value	Bit7	Bit6	Bit5	Bit4	Bit3	Bit2	Bit1	Bit0
0x20	IC Delay Channel 5	32	0x20	0	0	1	0	0	0	0	0
0x21	IC Delay Channel 6	224	0xE0	1	1	1	0	0	0	0	0
0x22	IC Delay Channel 7	96	0x60	0	1	1	0	0	0	0	0
0x23	IC Offset Delay Reg	0	0x00	0	0	0	0	0	0	0	0
0x24	PWM Sequence Timing	15	0x0F	0	0	0	0	1	1	1	1
0x25	PWM and, EMO Control	128	0x80	1	0	0	0	0	0	0	0
0x27	Individual Channel Shutdown	0	0x00	0	0	0	0	0	0	0	0
0x30	Input Mux Ch1&2	1	0x01	0	0	0	0	0	0	0	1
0x31	Input Mux Ch3&4	35	0x23	0	0	1	0	0	0	1	1
0x32	Input Mux Ch5&6	69	0x45	0	1	0	0	0	1	0	1
0x33	Input Mux Ch7&8	103	0x67	0	1	1	0	0	1	1	1
0x34	PWM Mux Ch1&2	1	0x01	0	0	0	0	0	0	0	1
0x35	PWM Mux Ch3&4	35	0x23	0	0	1	0	0	0	1	1
0x36	PWM Mux Ch5&6	69	0x45	0	1	0	0	0	1	0	1
0x37	PWM Mux Ch7&8	103	0x67	0	1	1	0	0	1	1	1
0x38	IC Delay Channel 0(BD Mode)	128	0x80	1	0	0	0	0	0	0	0
0x39	IC Delay Channel 1(BD Mode)	0	0x00	0	0	0	0	0	0	0	0
0x3A	IC Delay Channel 2(BD Mode)	192	0xC0	1	1	0	0	0	0	0	0
0x3B	IC Delay Channel 3(BD Mode)	64	0x40	0	1	0	0	0	0	0	0
0x3C	IC Delay Channel 4(BD Mode)	160	0xA0	1	0	1	0	0	0	0	0
0x3D	IC Delay Channel 5(BD Mode)	32	0x20	0	0	1	0	0	0	0	0
0x3E	IC Delay Channel 6(BD Mode)	224	0xE0	1	1	1	0	0	0	0	0
0x3F	IC Delay Channel 7(BD Mode)	96	0x60	0	1	1	0	0	0	0	0
0x40	Bank-switching command	0	0x00	0	0	0	0	0	0	0	0

Figure 8. Registers Tab (Selecting Biquad GUI)

5 Board Layouts, Schematic, and Bill of Materials

This section contains the PCB layouts, bill of materials, and schematic for the EVM.

5.1 TAS5548EVM Board Layouts

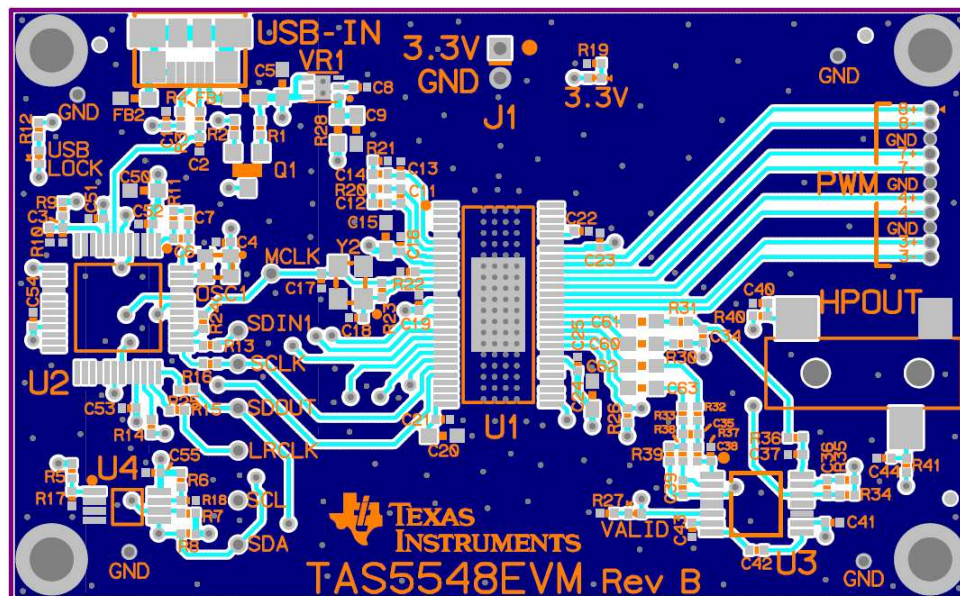

Figure 9. TAS5548EVM Top Composite Assembly

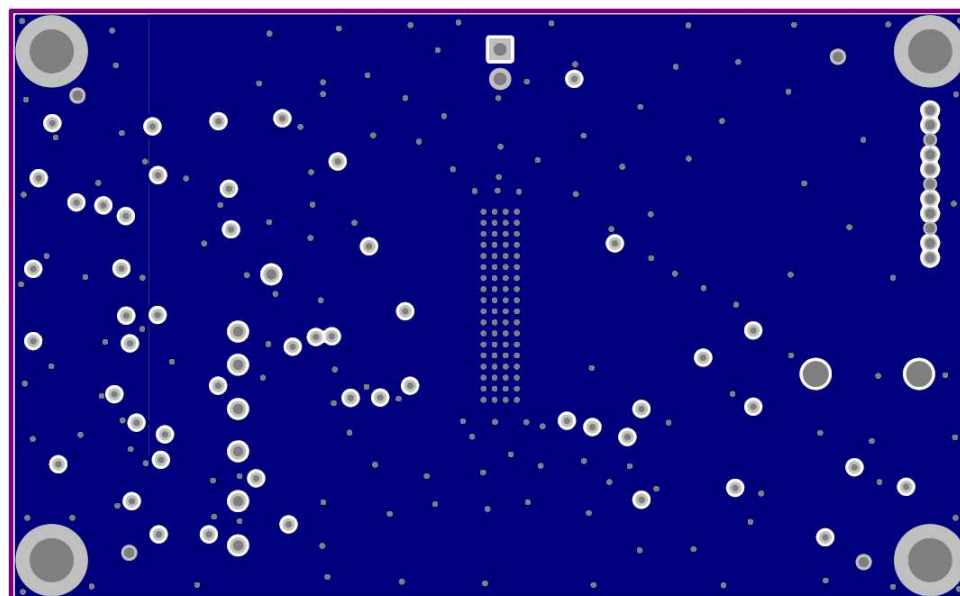

Figure 10. TAS5548EVM Top Copper Assembly

5.2 TAS5548EVM Schematic

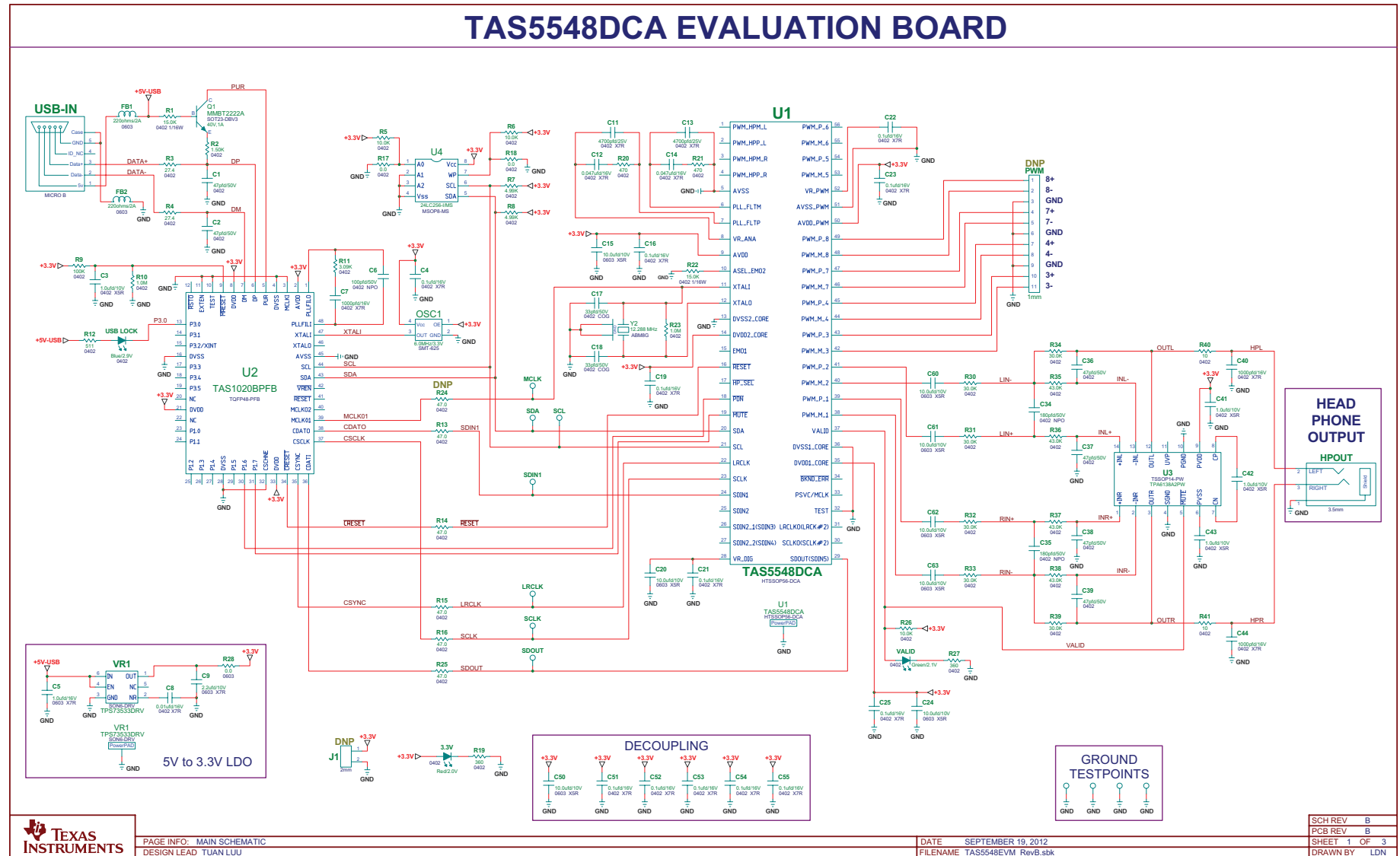

Figure 11. TAS5548EVM Schematic

5.3 TAS5548-5558EVM Bill of Materials

Table 1. TAS5548-5558EVM Bill of Materials

Item	MFG Part Number	RefDes	Description
1	TAS5548DCA	U1	8 CHAN HD AUDIO PROCESSOR W/PWM OUTPUTS HTSSOP56-DCA ROHS
2	TAS1020BPFB	U2	USB STREAMING CONTROLLER TQFP48-PFB ROHS
3	TPA6138A2PW	U3	DIRECTPATH HEADPHONE DRIVER W/ADJ GAIN TSSOP14-PW ROHS
4	24LC256-I/MS	U4	SERIAL EEPROM I2C 256K 400kHz MSOP8-MS ROHS
5	MMBT2222A-7-F	Q1	TRANSISTOR NPN GENERAL PURPOSE 40V 1A SOT23 DBV3 ROHS
6	TPS73533DRVT	VR1	LDO VOLTREG 3.3V 500mA LO NOISE HI PSRR SON6-DRV ROHS
7	625L3I006M00000	OSC1	OSCILLATOR SMT 6.0MHz 3.3V OUT-ENABLE ROHS
8	ABM8G-12.288MHZ-18-D2Y-T	Y2	CRYSTAL SMD-ABM8G SERIES 12.288MHz 30ppm 18PFD ROHS
9	SMLP12BC7TT86	USB LOCK	LED BLUE SMD0402 2.9V 10mA ROHS
10	SML-P12MTT86	VALID	LED GREEN SMD0402 2.1V 10mA ROHS
11	SML-P12UTT86	3.3V	LED RED SMD0402 2.0V 10mA ROHS
12	500R07N470JV4T	C1, C2, C36, C37, C38, C39	CAP SMD0402 CERM 47pfd 50V 5% COG ROHS
13	C1005X5R1A105K	C3, C41, C42, C43	CAP SMD0402 CERM 1.0UFD 10V 10% X5R ROHS
14	GRM155R71C104KA88D	C4, C16, C19, C21, C22, C23, C25, C51, C52, C53, C54, C55	CAP SMD0402 CERM 0.1UFD 16V X7R 10% ROHS
15	EMK107B7105KA-T	C5	CAP SMD0603 CERM 1.0UFD 16V 10% X7R ROHS
16	CC0402JRNPO9BN101	C6	CAP SMD0402 CERM 100pfd 50V 5% NPO ROHS
17	CC0402KRX7R7BB102	C7, C40, C44	CAP SMD0402 CERM 1000pfd 16V 10% X7R ROHS
18	0402YC103KAT2A	C8	CAP SMD0402 CERM 0.01ufd 16V 10% X7R ROHS
19	GRM188R71A225KE15D	C9	CAP SMD0603 CERM 2.2UFD 10V 10% X7R ROHS
20	CC0402KRX7R8BB472	C11, C13	CAP SMD0402 CERM 4700pfd 25V 10% X7R ROHS
21	EMK105B7473KV-F	C12, C14	CAP SMD0402 CERM 0.047UFD 16V 10% X7R ROHS
22	LMK107BJ106MALTD	C15, C20, C24, C50, C60, C61, C62, C63	CAP SMD0603 CERM 10.0UFD 10V 20% X5R ROHS
23	GRM1555C1H330JZ01D	C17, C18	CAP SMD0402 CERM 33PFD 5% 50V COG ROHS
24	GRM1555C1H181JA01D	C34, C35	CAP SMD0402 CERM 180PFD 5% 50V NPO ROHS
25	RC0402FR-0715KL	R1, R22	RESISTOR SMD0402 THICK FILM 15.0K OHM 1% 1/16W ROHS
26	RMCF0402FT1K50	R2	RESISTOR SMD0402 1.50K OHMS 1% 1/16W ROHS
27	ERJ-2RKF27R4X	R3, R4	RESISTOR SMD0402 THICK FILM 27.4 OHMS 1/10W 1% ROHS
28	CRCW040210K0FKED	R5, R6	RESISTOR SMD0402 10.0K OHMS 1% 1/16W ROHS
29	ERJ-2RKF4991X	R7, R8	RESISTOR SMD0402 4.99K 1%,1/16W ROHS
30	ERJ-2RKF1003X	R9	RESISTOR SMD0402 THICK FILM 100K OHMS 1/16W 1% ROHS

Table 1. TAS5548-5558EVM Bill of Materials (continued)

Item	MFG Part Number	RefDes	Description
31	RMCF0402FT1M00	R10, R23	RESISTOR SMD0402 1.0M OHMS 1% 1/16W ROHS
32	RC0402FR-073K09L	R11	RESISTOR SMD0402 THICK FILM 3.09K OHM 1% 1/16W ROHS
33	RC0402FR-07511RL	R12	RESISTOR SMD0402 THICK FILM 511 OHMS 1% 1/16W ROHS
34	RC0402FR-0747RL	R13, R14, R15, R16, R24, R25	RESISTOR SMD0402 THICK FILM 47.0 OHMS 1% 1/16W ROHS
35	RMCF0402ZT0R00	R17, R18	ZERO OHM JUMPER SMT 0402 0 OHM 1/16W,5% ROHS
36	CRCW0402360RFKED	R19, R27	RESISTOR SMD0402 360 1/16W 1% ROHS
37	ERJ-2RKF4700X	R20, R21	RESISTOR SMD0402 THICK FILM 470 OHMS 1/10W 1% ROHS
38	CRCW040210K0FKED	R26	RESISTOR SMD0402 10.0K OHMS 1% 1/16W ROHS
39	RMCF0603ZT0R00	R28	RESISTOR SMD0603 ZERO OHMS 1/10W ROHS
40	ERJ-2RKF4302X	R35, R36, R37, R38	RESISTOR SMD0402 THICK FILM 43.0K OHMS 1/10W 1% ROHS
41	RC0402FR-0730KL	R30, R31, R32, R33, R34, R39	RESISTOR SMD0402 THICK FILM 30.0K OHMS 1% 1/16W ROHS
42	CRCW040210R0JNED	R40, R41	RESISTOR SMD0402 10 OHMS 1/16W 1% ROHS
43	MPZ1608S221A	FB1, FB2	FERRITE CHIP, 220 OHMS 2A 100MHZ SMD 0603 ROHS
44	SJ-3523-SMT	HPOUT	JACK AUDIO-STEREO MINI(3.5MM),3-COND SMT-RA ROHS
45	47346-0001	USB-IN	JACK USB FEMALE TYPEB MICRO SMT-RA 5PIN ROHS

EVALUATION BOARD/KIT/MODULE (EVM) ADDITIONAL TERMS

Texas Instruments (TI) provides the enclosed Evaluation Board/Kit/Module (EVM) under the following conditions:

The user assumes all responsibility and liability for proper and safe handling of the goods. Further, the user indemnifies TI from all claims arising from the handling or use of the goods.

Should this evaluation board/kit not meet the specifications indicated in the User's Guide, the board/kit may be returned within 30 days from the date of delivery for a full refund. THE FOREGOING LIMITED WARRANTY IS THE EXCLUSIVE WARRANTY MADE BY SELLER TO BUYER AND IS IN LIEU OF ALL OTHER WARRANTIES, EXPRESSED, IMPLIED, OR STATUTORY, INCLUDING ANY WARRANTY OF MERCHANTABILITY OR FITNESS FOR ANY PARTICULAR PURPOSE. EXCEPT TO THE EXTENT OF THE INDEMNITY SET FORTH ABOVE, NEITHER PARTY SHALL BE LIABLE TO THE OTHER FOR ANY INDIRECT, SPECIAL, INCIDENTAL, OR CONSEQUENTIAL DAMAGES.

Please read the User's Guide and, specifically, the Warnings and Restrictions notice in the User's Guide prior to handling the product. This notice contains important safety information about temperatures and voltages. For additional information on TI's environmental and/or safety programs, please visit www.ti.com/esh or contact TI.

No license is granted under any patent right or other intellectual property right of TI covering or relating to any machine, process, or combination in which such TI products or services might be or are used. TI currently deals with a variety of customers for products, and therefore our arrangement with the user is not exclusive. TI assumes no liability for applications assistance, customer product design, software performance, or infringement of patents or services described herein.

REGULATORY COMPLIANCE INFORMATION

As noted in the EVM User's Guide and/or EVM itself, this EVM and/or accompanying hardware may or may not be subject to the Federal Communications Commission (FCC) and Industry Canada (IC) rules.

For EVMs **not** subject to the above rules, this evaluation board/kit/module is intended for use for ENGINEERING DEVELOPMENT, DEMONSTRATION OR EVALUATION PURPOSES ONLY and is not considered by TI to be a finished end product fit for general consumer use. It generates, uses, and can radiate radio frequency energy and has not been tested for compliance with the limits of computing devices pursuant to part 15 of FCC or ICES-003 rules, which are designed to provide reasonable protection against radio frequency interference. Operation of the equipment may cause interference with radio communications, in which case the user at his own expense will be required to take whatever measures may be required to correct this interference.

General Statement for EVMs including a radio

User Power/Frequency Use Obligations: This radio is intended for development/professional use only in legally allocated frequency and power limits. Any use of radio frequencies and/or power availability of this EVM and its development application(s) must comply with local laws governing radio spectrum allocation and power limits for this evaluation module. It is the user's sole responsibility to only operate this radio in legally acceptable frequency space and within legally mandated power limitations. Any exceptions to this are strictly prohibited and unauthorized by Texas Instruments unless user has obtained appropriate experimental/development licenses from local regulatory authorities, which is responsibility of user including its acceptable authorization.

For EVMs annotated as FCC – FEDERAL COMMUNICATIONS COMMISSION Part 15 Compliant

Caution

This device complies with part 15 of the FCC Rules. Operation is subject to the following two conditions: (1) This device may not cause harmful interference, and (2) this device must accept any interference received, including interference that may cause undesired operation.

Changes or modifications not expressly approved by the party responsible for compliance could void the user's authority to operate the equipment.

FCC Interference Statement for Class A EVM devices

This equipment has been tested and found to comply with the limits for a Class A digital device, pursuant to part 15 of the FCC Rules. These limits are designed to provide reasonable protection against harmful interference when the equipment is operated in a commercial environment. This equipment generates, uses, and can radiate radio frequency energy and, if not installed and used in accordance with the instruction manual, may cause harmful interference to radio communications. Operation of this equipment in a residential area is likely to cause harmful interference in which case the user will be required to correct the interference at his own expense.

FCC Interference Statement for Class B EVM devices

This equipment has been tested and found to comply with the limits for a Class B digital device, pursuant to part 15 of the FCC Rules. These limits are designed to provide reasonable protection against harmful interference in a residential installation. This equipment generates, uses and can radiate radio frequency energy and, if not installed and used in accordance with the instructions, may cause harmful interference to radio communications. However, there is no guarantee that interference will not occur in a particular installation. If this equipment does cause harmful interference to radio or television reception, which can be determined by turning the equipment off and on, the user is encouraged to try to correct the interference by one or more of the following measures:

- Reorient or relocate the receiving antenna.
- Increase the separation between the equipment and receiver.
- Connect the equipment into an outlet on a circuit different from that to which the receiver is connected.
- Consult the dealer or an experienced radio/TV technician for help.

For EVMs annotated as IC – INDUSTRY CANADA Compliant

This Class A or B digital apparatus complies with Canadian ICES-003.

Changes or modifications not expressly approved by the party responsible for compliance could void the user's authority to operate the equipment.

Concerning EVMs including radio transmitters

This device complies with Industry Canada licence-exempt RSS standard(s). Operation is subject to the following two conditions: (1) this device may not cause interference, and (2) this device must accept any interference, including interference that may cause undesired operation of the device.

Concerning EVMs including detachable antennas

Under Industry Canada regulations, this radio transmitter may only operate using an antenna of a type and maximum (or lesser) gain approved for the transmitter by Industry Canada. To reduce potential radio interference to other users, the antenna type and its gain should be so chosen that the equivalent isotropically radiated power (e.i.r.p.) is not more than that necessary for successful communication.

This radio transmitter has been approved by Industry Canada to operate with the antenna types listed in the user guide with the maximum permissible gain and required antenna impedance for each antenna type indicated. Antenna types not included in this list, having a gain greater than the maximum gain indicated for that type, are strictly prohibited for use with this device.

Cet appareil numérique de la classe A ou B est conforme à la norme NMB-003 du Canada.

Les changements ou les modifications pas expressément approuvés par la partie responsable de la conformité ont pu vider l'autorité de l'utilisateur pour actionner l'équipement.

Concernant les EVMs avec appareils radio

Le présent appareil est conforme aux CNR d'Industrie Canada applicables aux appareils radio exempts de licence. L'exploitation est autorisée aux deux conditions suivantes : (1) l'appareil ne doit pas produire de brouillage, et (2) l'utilisateur de l'appareil doit accepter tout brouillage radioélectrique subi, même si le brouillage est susceptible d'en compromettre le fonctionnement.

Concernant les EVMs avec antennes détachables

Conformément à la réglementation d'Industrie Canada, le présent émetteur radio peut fonctionner avec une antenne d'un type et d'un gain maximal (ou inférieur) approuvé pour l'émetteur par Industrie Canada. Dans le but de réduire les risques de brouillage radioélectrique à l'intention des autres utilisateurs, il faut choisir le type d'antenne et son gain de sorte que la puissance isotrope rayonnée équivalente (p.i.r.e.) ne dépasse pas l'intensité nécessaire à l'établissement d'une communication satisfaisante.

Le présent émetteur radio a été approuvé par Industrie Canada pour fonctionner avec les types d'antenne énumérés dans le manuel d'usage et ayant un gain admissible maximal et l'impédance requise pour chaque type d'antenne. Les types d'antenne non inclus dans cette liste, ou dont le gain est supérieur au gain maximal indiqué, sont strictement interdits pour l'exploitation de l'émetteur.

【Important Notice for Users of EVMs for RF Products in Japan】

This development kit is NOT certified as Confirming to Technical Regulations of Radio Law of Japan

If you use this product in Japan, you are required by Radio Law of Japan to follow the instructions below with respect to this product:

1. Use this product in a shielded room or any other test facility as defined in the notification #173 issued by Ministry of Internal Affairs and Communications on March 28, 2006, based on Sub-section 1.1 of Article 6 of the Ministry's Rule for Enforcement of Radio Law of Japan,
2. Use this product only after you obtained the license of Test Radio Station as provided in Radio Law of Japan with respect to this product, or
3. Use of this product only after you obtained the Technical Regulations Conformity Certification as provided in Radio Law of Japan with respect to this product. Also, please do not transfer this product, unless you give the same notice above to the transferee. Please note that if you could not follow the instructions above, you will be subject to penalties of Radio Law of Japan.

Texas Instruments Japan Limited
(address) 24-1, Nishi-Shinjuku 6 chome, Shinjuku-ku, Tokyo, Japan

<http://www.tij.co.jp>

【無線電波を送信する製品の開発キットをお使いになる際の注意事項】

本開発キットは技術基準適合証明を受けておりません。

本製品のご使用に際しては、電波法遵守のため、以下のいずれかの措置を取っていただく必要がありますのでご注意ください。

1. 電波法施行規則第6条第1項第1号に基づく平成18年3月28日総務省告示第173号で定められた電波暗室等の試験設備でご使用いただく。
2. 実験局の免許を取得後ご使用いただく。
3. 技術基準適合証明を取得後ご使用いただく。

なお、本製品は、上記の「ご使用にあたっての注意」を譲渡先、移転先に通知しない限り、譲渡、移転できないものとします。

上記を遵守頂けない場合は、電波法の罰則が適用される可能性があることをご留意ください。

日本テキサス・インスツルメンツ株式会社
東京都新宿区西新宿6丁目24番1号
西新宿三井ビル

<http://www.tij.co.jp>

EVALUATION BOARD/KIT/MODULE (EVM) WARNINGS, RESTRICTIONS AND DISCLAIMERS

For Feasibility Evaluation Only, in Laboratory/Development Environments. Unless otherwise indicated, this EVM is not a finished electrical equipment and not intended for consumer use. It is intended solely for use for preliminary feasibility evaluation in laboratory/development environments by technically qualified electronics experts who are familiar with the dangers and application risks associated with handling electrical mechanical components, systems and subsystems. It should not be used as all or part of a finished end product.

Your Sole Responsibility and Risk. You acknowledge, represent and agree that:

1. You have unique knowledge concerning Federal, State and local regulatory requirements (including but not limited to Food and Drug Administration regulations, if applicable) which relate to your products and which relate to your use (and/or that of your employees, affiliates, contractors or designees) of the EVM for evaluation, testing and other purposes.
2. You have full and exclusive responsibility to assure the safety and compliance of your products with all such laws and other applicable regulatory requirements, and also to assure the safety of any activities to be conducted by you and/or your employees, affiliates, contractors or designees, using the EVM. Further, you are responsible to assure that any interfaces (electronic and/or mechanical) between the EVM and any human body are designed with suitable isolation and means to safely limit accessible leakage currents to minimize the risk of electrical shock hazard.
3. Since the EVM is not a completed product, it may not meet all applicable regulatory and safety compliance standards (such as UL, CSA, VDE, CE, RoHS and WEEE) which may normally be associated with similar items. You assume full responsibility to determine and/or assure compliance with any such standards and related certifications as may be applicable. You will employ reasonable safeguards to ensure that your use of the EVM will not result in any property damage, injury or death, even if the EVM should fail to perform as described or expected.
4. You will take care of proper disposal and recycling of the EVM's electronic components and packing materials.

Certain Instructions. It is important to operate this EVM within TI's recommended specifications and environmental considerations per the user guidelines. Exceeding the specified EVM ratings (including but not limited to input and output voltage, current, power, and environmental ranges) may cause property damage, personal injury or death. If there are questions concerning these ratings please contact a TI field representative prior to connecting interface electronics including input power and intended loads. Any loads applied outside of the specified output range may result in unintended and/or inaccurate operation and/or possible permanent damage to the EVM and/or interface electronics. Please consult the EVM User's Guide prior to connecting any load to the EVM output. If there is uncertainty as to the load specification, please contact a TI field representative. During normal operation, some circuit components may have case temperatures greater than 60°C as long as the input and output are maintained at a normal ambient operating temperature. These components include but are not limited to linear regulators, switching transistors, pass transistors, and current sense resistors which can be identified using the EVM schematic located in the EVM User's Guide. When placing measurement probes near these devices during normal operation, please be aware that these devices may be very warm to the touch. As with all electronic evaluation tools, only qualified personnel knowledgeable in electronic measurement and diagnostics normally found in development environments should use these EVMs.

Agreement to Defend, Indemnify and Hold Harmless. You agree to defend, indemnify and hold TI, its licensors and their representatives harmless from and against any and all claims, damages, losses, expenses, costs and liabilities (collectively, "Claims") arising out of or in connection with any use of the EVM that is not in accordance with the terms of the agreement. This obligation shall apply whether Claims arise under law of tort or contract or any other legal theory, and even if the EVM fails to perform as described or expected.

Safety-Critical or Life-Critical Applications. If you intend to evaluate the components for possible use in safety critical applications (such as life support) where a failure of the TI product would reasonably be expected to cause severe personal injury or death, such as devices which are classified as FDA Class III or similar classification, then you must specifically notify TI of such intent and enter into a separate Assurance and Indemnity Agreement.

Mailing Address: Texas Instruments, Post Office Box 655303, Dallas, Texas 75265
Copyright © 2013, Texas Instruments Incorporated

IMPORTANT NOTICE

Texas Instruments Incorporated and its subsidiaries (TI) reserve the right to make corrections, enhancements, improvements and other changes to its semiconductor products and services per JESD46, latest issue, and to discontinue any product or service per JESD48, latest issue. Buyers should obtain the latest relevant information before placing orders and should verify that such information is current and complete. All semiconductor products (also referred to herein as "components") are sold subject to TI's terms and conditions of sale supplied at the time of order acknowledgment.

TI warrants performance of its components to the specifications applicable at the time of sale, in accordance with the warranty in TI's terms and conditions of sale of semiconductor products. Testing and other quality control techniques are used to the extent TI deems necessary to support this warranty. Except where mandated by applicable law, testing of all parameters of each component is not necessarily performed.

TI assumes no liability for applications assistance or the design of Buyers' products. Buyers are responsible for their products and applications using TI components. To minimize the risks associated with Buyers' products and applications, Buyers should provide adequate design and operating safeguards.

TI does not warrant or represent that any license, either express or implied, is granted under any patent right, copyright, mask work right, or other intellectual property right relating to any combination, machine, or process in which TI components or services are used. Information published by TI regarding third-party products or services does not constitute a license to use such products or services or a warranty or endorsement thereof. Use of such information may require a license from a third party under the patents or other intellectual property of the third party, or a license from TI under the patents or other intellectual property of TI.

Reproduction of significant portions of TI information in TI data books or data sheets is permissible only if reproduction is without alteration and is accompanied by all associated warranties, conditions, limitations, and notices. TI is not responsible or liable for such altered documentation. Information of third parties may be subject to additional restrictions.

Resale of TI components or services with statements different from or beyond the parameters stated by TI for that component or service voids all express and any implied warranties for the associated TI component or service and is an unfair and deceptive business practice. TI is not responsible or liable for any such statements.

Buyer acknowledges and agrees that it is solely responsible for compliance with all legal, regulatory and safety-related requirements concerning its products, and any use of TI components in its applications, notwithstanding any applications-related information or support that may be provided by TI. Buyer represents and agrees that it has all the necessary expertise to create and implement safeguards which anticipate dangerous consequences of failures, monitor failures and their consequences, lessen the likelihood of failures that might cause harm and take appropriate remedial actions. Buyer will fully indemnify TI and its representatives against any damages arising out of the use of any TI components in safety-critical applications.

In some cases, TI components may be promoted specifically to facilitate safety-related applications. With such components, TI's goal is to help enable customers to design and create their own end-product solutions that meet applicable functional safety standards and requirements. Nonetheless, such components are subject to these terms.

No TI components are authorized for use in FDA Class III (or similar life-critical medical equipment) unless authorized officers of the parties have executed a special agreement specifically governing such use.

Only those TI components which TI has specifically designated as military grade or "enhanced plastic" are designed and intended for use in military/aerospace applications or environments. Buyer acknowledges and agrees that any military or aerospace use of TI components which have **not** been so designated is solely at the Buyer's risk, and that Buyer is solely responsible for compliance with all legal and regulatory requirements in connection with such use.

TI has specifically designated certain components as meeting ISO/TS16949 requirements, mainly for automotive use. In any case of use of non-designated products, TI will not be responsible for any failure to meet ISO/TS16949.

Products

Audio	www.ti.com/audio
Amplifiers	amplifier.ti.com
Data Converters	dataconverter.ti.com
DLP® Products	www.dlp.com
DSP	dsp.ti.com
Clocks and Timers	www.ti.com/clocks
Interface	interface.ti.com
Logic	logic.ti.com
Power Mgmt	power.ti.com
Microcontrollers	microcontroller.ti.com
RFID	www.ti-rfid.com
OMAP Applications Processors	www.ti.com/omap
Wireless Connectivity	www.ti.com/wirelessconnectivity

Applications

Automotive and Transportation	www.ti.com/automotive
Communications and Telecom	www.ti.com/communications
Computers and Peripherals	www.ti.com/computers
Consumer Electronics	www.ti.com/consumer-apps
Energy and Lighting	www.ti.com/energy
Industrial	www.ti.com/industrial
Medical	www.ti.com/medical
Security	www.ti.com/security
Space, Avionics and Defense	www.ti.com/space-avionics-defense
Video and Imaging	www.ti.com/video

TI E2E Community

e2e.ti.com