

承 认 书

SPECIFICATION FOR APPROVAL

客户 (CUSTOMER): _____

产品名称 (PRODUCT NAME): 电磁式蜂鸣器 (外部驱动)

型号 (TYPE): YS-MBZ12095C05R42K2700

客户料号 (CUSTOMER NO): _____

日期 (DATE): 2021-09-02

客户确认: (签章)
日期:

东 莞 市 锋 鸣 电 子 有 限 公 司

电话: 0769-88036425

传真: 0769-85474556

制单: 李琳

业务: 宋浩亮

工程: 黄鑫

FENGMING TECH OF DONGGUAN CO.,LTD

YS-MBZ12095C05R42K2700

DIMENSIONS Unit:mm Tolerance: ± 0.5

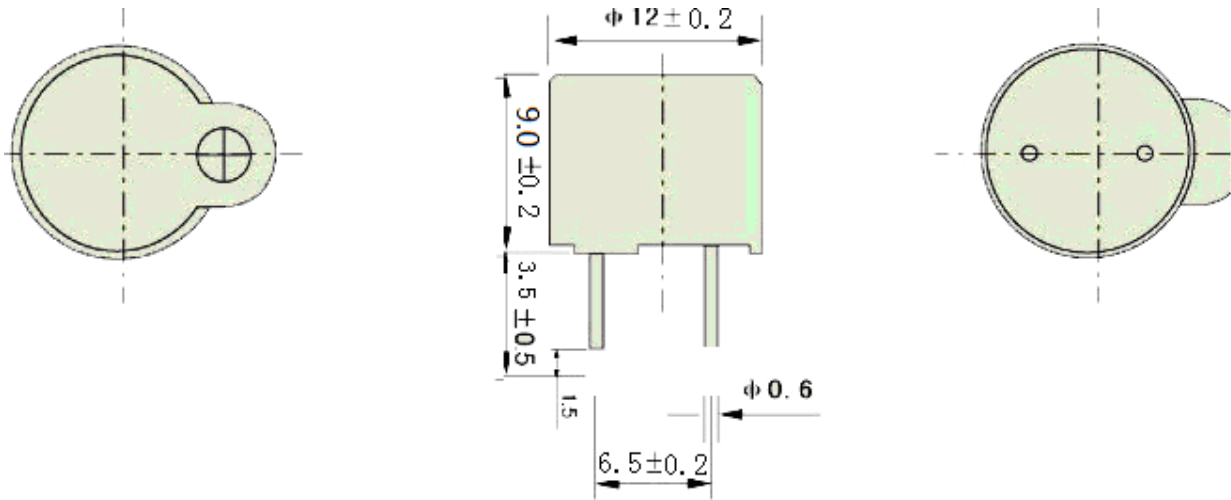

SPECIFICATIONS:

Model NO	YS-MBZ12095C05R42K2700
Rated Voltage	5V
Operating Voltage	3.0~7.0V
Rated Current	Max. 50mA
Coil Resistance	$42 \pm 4 \Omega$
sound Pressure level(dB/2400Hz/at 10cm)	Min.85dB
Resonant Frequency	2700Hz
Operating Temperature	$-20^{\circ}\text{C} \sim +70^{\circ}\text{C}$
Storage Temperature	$-30^{\circ}\text{C} \sim +80^{\circ}\text{C}$

Acoustic Characteristics:

The oscillation frequency, current consumption and sound pressure are measured by the measuring instruments shown below

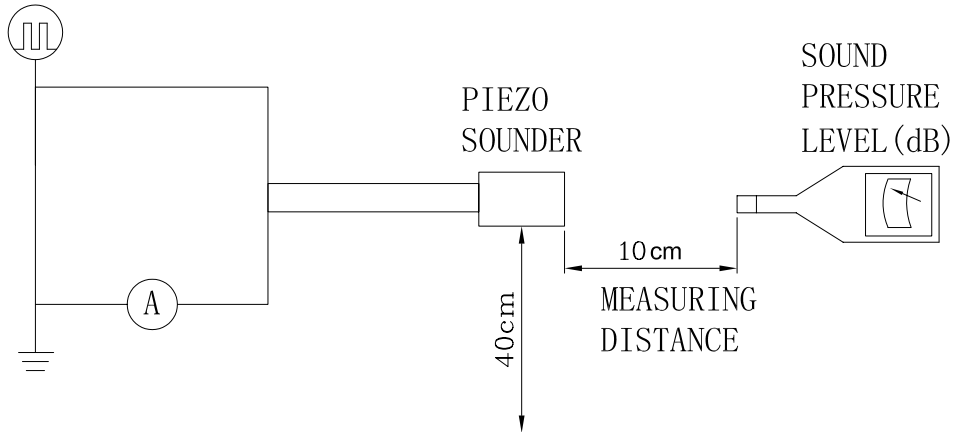

In the measuring test, buzzer is placed as follows:

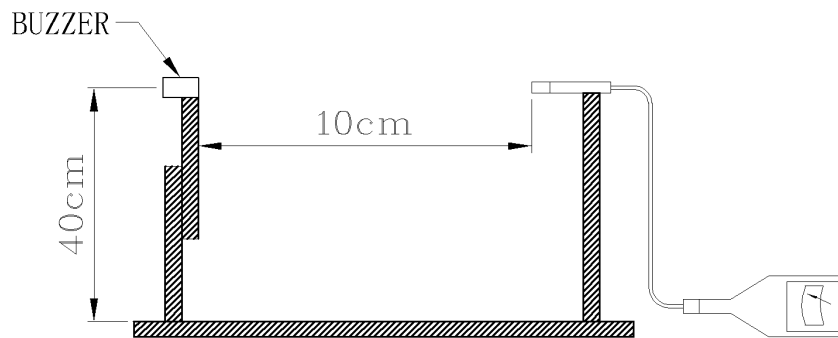

Typical Frequency Response Curve

