



KTX-WB9214125AZZZ

KTX Prime

CONTRAST SENSORS

SICK
Sensor Intelligence.



Ordering information

Type	Part no.
KTX-WB9214125AZZZZ	1081722

Other models and accessories → www.sick.com/KTX_Prime



Detailed technical data

Features

Dimensions (W x H x D)	30 mm x 53 mm x 78.5 mm
Sensing distance	13 mm
Sensing distance tolerance	± 5 mm
Housing design (light emission)	Rectangular
Light source	LED, RGB ¹⁾
Wave length	470 nm, 525 nm, 625 nm
Light emission	Long side of housing
Light spot size	3.8 mm x 0.9 mm
Light spot direction	Horizontal ²⁾
Teach-in mode	1-point teach-in, 2-point teach-in, dynamic Teach-in, auto mode
Output function	Light/dark switching
Delay time	Adjustable
Delivery status	2-point teach-in
Parameter presettings	None

¹⁾ Average service life: 100,000 h at T_J = +25 °C.

²⁾ In relation to long side of housing.

Mechanics/electronics

Supply voltage	10.8 V DC ... 28.8 V DC ¹⁾
Ripple	$\leq 5 V_{pp}$ ²⁾
Power consumption	< 100 mA ³⁾
Switching frequency	50 kHz ⁴⁾
Response time	10 μ s ⁵⁾
Jitter	5 μ s
Switching output	PUSH/PULL
Switching output (voltage)	Push/Pull: HIGH = $V_S - 3 V$ / LOW $\leq 3 V$
Output current I_{max}	100 mA ⁶⁾
Input, blanking input (AT)	Blanked: U = 10 V ... < U _v : free-running: U < 2 V
Input, fine/coarse (F/C)	Coarse: U = 10 V ... < U _v : fine: U < 2 V
Input, light/dark (L/D)	Light: U = 10 V ... < U _v : light: U < 2 V
Retention time (ET)	25 ms, non-volatile memory
Connection type	Male connector M12, 5-pin
Protection class	III
Circuit protection	U _v connections, reverse polarity protected Output Q short-circuit protected Interference pulse suppression
Enclosure rating	IP67
Weight	94 g
Housing material	VISTAL®

¹⁾ Limit values: DC 12 V (-10 %) ... DC 24 V (+20 %). Operation in short-circuit protected network max. 8 A.

²⁾ May not exceed or fall below U_v tolerances.

³⁾ Without load.

⁴⁾ With light/dark ratio 1:1.

⁵⁾ Signal transit time with resistive load.

⁶⁾ Total current of all Outputs.

Ambient data

Ambient operating temperature	-20 °C ... +60 °C
Ambient storage temperature	-25 °C ... +75 °C
Shock load	According to IEC 60068-2-27 (30 g/11 ms)
UL File No.	E181493

Classifications

ECl@ss 5.0	27270906
ECl@ss 5.1.4	27270906
ECl@ss 6.0	27270906
ECl@ss 6.2	27270906
ECl@ss 7.0	27270906
ECl@ss 8.0	27270906
ECl@ss 8.1	27270906
ECl@ss 9.0	27270906

ETIM 5.0	EC001820
ETIM 6.0	EC001820
UNSPSC 16.0901	39121528

Communication interface

Communication interface	IO-Link V1.1
Communication Interface detail	COM2 (38,4 kBaud)
Cycle time	2.3 ms
Process data length	16 Bit
Process data structure	Bit 0 = switching signal Q _{L1} Bit 1 = empty Bit 2 = Quality of Run Alarm Bit 3 ... 5 = Emission Color Bit 6 ... 15 = Measurement Value Emission Color

Dimensional drawing (Dimensions in mm (inch))

KTX Prime

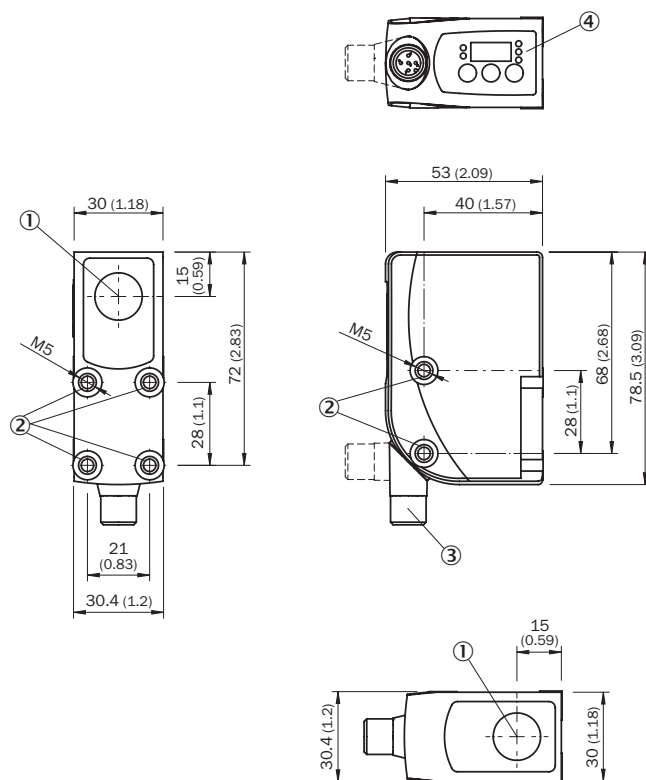

- ① Optical axis and light emission edge / length housing side
- ② Threaded mounting hole M5
- ③ Connector M12 (rotatable up to 180°)
- ④ Control panel

Adjustments

KTS/KTX Prime

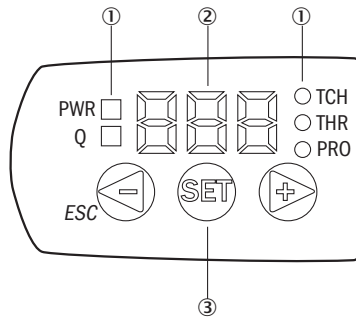

- ① LED status indicator
- ② Display
- ③ Control panel

Connection diagram

Cd-387

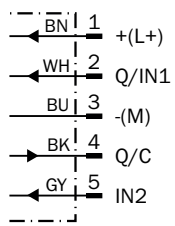

Concept of operation

KTS/KTX Prime - Setting the switching threshold (dynamic Teach-in)

Suitable for teaching in moving objects.

1. Position background

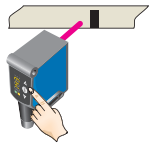

Press the Set pushbutton to start the teach-in process.

2. Move at least the mark and background using the light spot

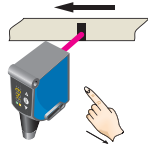

The display lights up during repeat length detection (---).

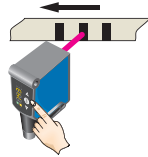

Press the Set pushbutton to end the teach-in process. The Quality of Teach is displayed.

Example

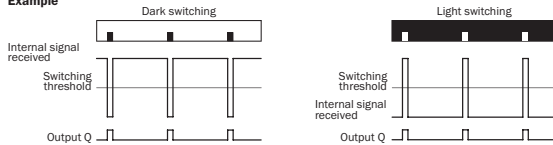

Switching characteristics

The optimum emitted light is selected automatically (at RGB variants).

Static teach-in: light/dark setting is defined using teach-in sequence.

Dynamic teach-in: switching output active on mark, if background is longer in the field of view during the teach-in.

The switching threshold is set in the center between the background and the mark.

Keylock (activation and deactivation): Press and hold the "+" pushbutton > 10 s.

The Q-LED (yellow) flashes and the "Err" error message appears on the display.

KTS/KTX Prime - setting the switching threshold (2-point teach-in)

Suitable for manual positioning of the object to be detected, e.g. marks and background.

1. Position mark

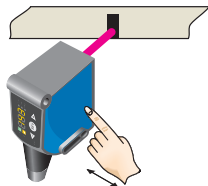

When setting the contrasts to be detected, "1st" flashes. Press set button.

2. Position background

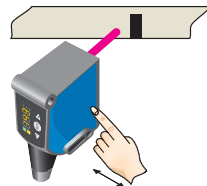

When setting the contrasts to be detected, "2nd" flashes. Press set button. The Quality of Teach is displayed.

KTS/KTX Prime - Setting the switching threshold (color mode)

Suitable for teaching in color properties.

1. Position mark/color property

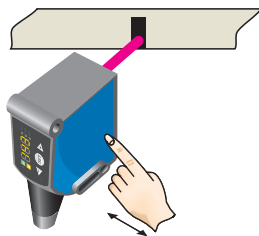

When detecting the contrast or color to be detected, "1st" flashes. Press set button. The Quality of Teach-in is displayed.



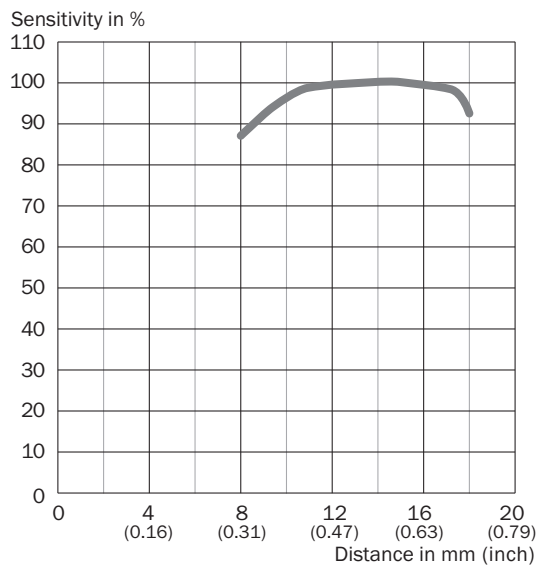

Characteristic curve

Sensing distance 13 mm, light spot direction horizontal/vertical



Recommended accessories

Other models and accessories → www.sick.com/KTX_Prime

	Brief description	Type	Part no.
Universal bar clamp systems			
	Plate G for universal clamp bracket, steel, zinc coated, universal clamp and mounting hardware included	BEF-KHS-G01	2022464
	Plate K for universal clamp bracket, steel, zinc coated, universal clamp and mounting hardware included	BEF-KHS-K01	2022718
	Universal clamp bracket for rod mounting, steel, zinc coated, without mounting hardware	BEF-KHS-KH1	2022726
	Mounting bar, straight, 200 mm, steel, steel, zinc coated, without mounting hardware	BEF-MS12G-A	4056054
	Mounting bar, straight, 300 mm, steel, steel, zinc coated, without mounting hardware	BEF-MS12G-B	4056055
	Mounting bar, L-shaped, 150 mm x 150 mm, steel, steel, zinc coated, without mounting hardware	BEF-MS12L-A	4056052
	Mounting bar, L-shaped, 250 x 250 mm, steel, steel, zinc coated, without mounting hardware	BEF-MS12L-B	4056053

SICK AT A GLANCE

SICK is one of the leading manufacturers of intelligent sensors and sensor solutions for industrial applications. A unique range of products and services creates the perfect basis for controlling processes securely and efficiently, protecting individuals from accidents and preventing damage to the environment.

We have extensive experience in a wide range of industries and understand their processes and requirements. With intelligent sensors, we can deliver exactly what our customers need. In application centers in Europe, Asia and North America, system solutions are tested and optimized in accordance with customer specifications. All this makes us a reliable supplier and development partner.

Comprehensive services complete our offering: SICK LifeTime Services provide support throughout the machine life cycle and ensure safety and productivity.

For us, that is “Sensor Intelligence.”

WORLDWIDE PRESENCE:

Contacts and other locations –www.sick.com