

Small Signal Product
0.3 Watts, PNP Plastic-Encapsulate Transistor

FEATURES

- Ideally suited for automatic insertion
- Epitaxial planar die construction
- For switching, AF driver and amplifier applications
- Complementary NPN type available (BC817)

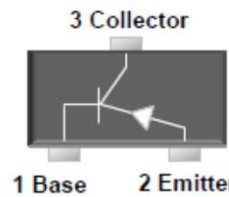

MECHANICAL DATA

- Case: SOT- 23, Molded plastic
- Terminal: Solderable per MIL-STD-202, method 208
- Case material: Molded plastic, UL flammability classification rating 94V-0
- Moisture sensitivity: Level 1 per J-STD-020C
- Lead free plating
- Weight: 0.008grams (approximately)

SOT-23

MAXIMUM RATINGS AND ELECTRICAL CHARACTERISTICS ($T_A=25^\circ\text{C}$ unless otherwise noted)			
PARAMETER	SYMBOL	VALUE	UNIT
Power Dissipation	P_D	0.3	W
Collector Current - Continuous	I_C	-0.5	A
Junction Temperature	T_J	150	$^\circ\text{C}$
Storage Temperature Range	T_{STG}	-55 to + 150	$^\circ\text{C}$

PARAMETER	SYMBOL	VALUE	UNIT	
Collector-Base Breakdown Voltage	V_{CBO}	-50	V	
Collector-Emitter Breakdown Voltage	V_{CEO}	-45	V	
Emitter-Base Breakdown Voltage	V_{EBO}	-5	V	
Collector Cut-off Current	I_{CBO}	$V_{CB} = -45\text{ V } I_E = 0$	-0.1	μA
		$V_{CB} = -40\text{ V } I_B = 0$	-0.2	μA
Emitter Cut-off Current	I_{EBO}	-0.1	μA	
Collector-Emitter Saturation Voltage	$V_{CE(sat)}$	-0.7	V	
Base-Emitter Saturation Voltage	$V_{BE(sat)}$	-1.2	V	
Transition Frequency	f_T	80	MHz	
DC Current Gain	$h_{FE(1)}$	807-16	100	250
		807-25	160	400
		807-40	250	600

Small Signal Product

RATINGS AND CHARACTERISTICS CURVES

(TA=25°C unless otherwise noted)

Fig. 1 Power Derating Curve

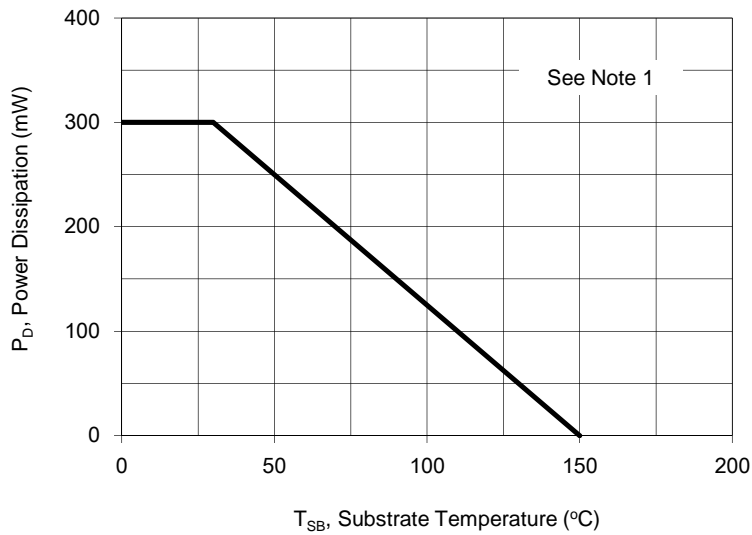

Fig. 2 Gain Bandwidth Product VS. Collector Current

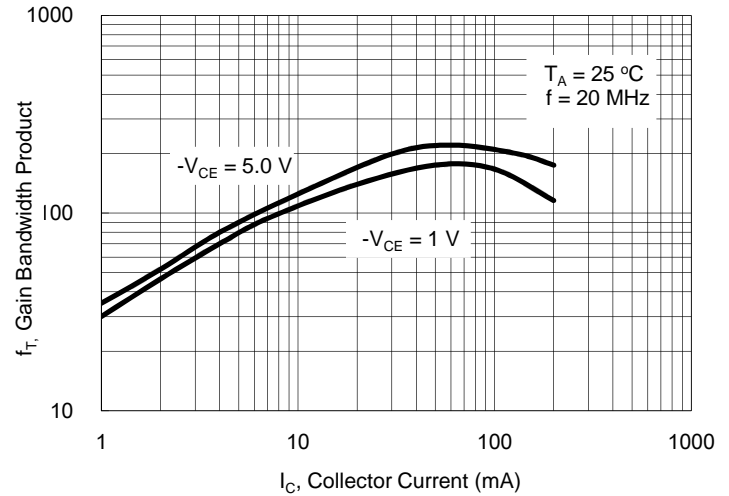

Fig.3 Collector Sat Voltage VS. Collector Current

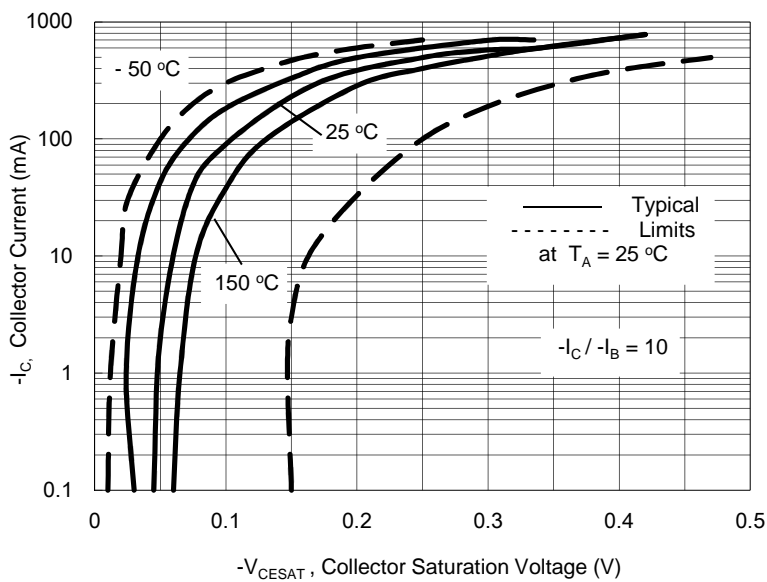

Fig. 4 DC Current Gain VS. Collector Current

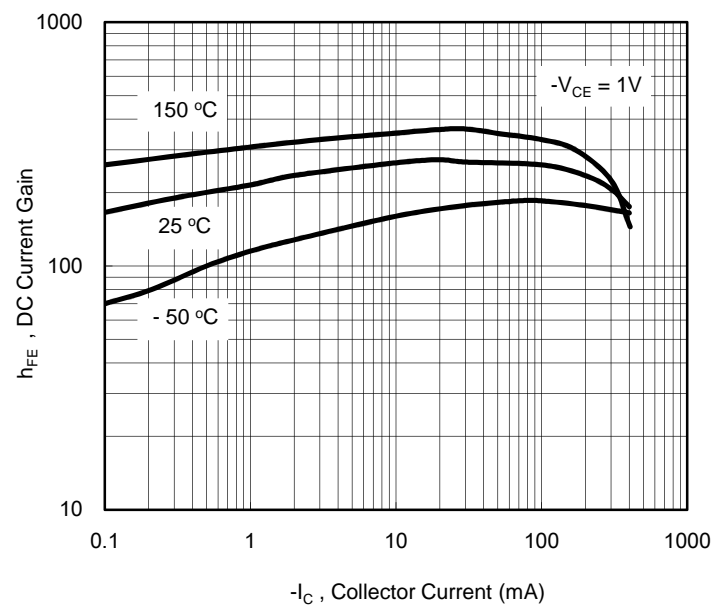

Fig.5 Typical Emitter-Collector Characteristics

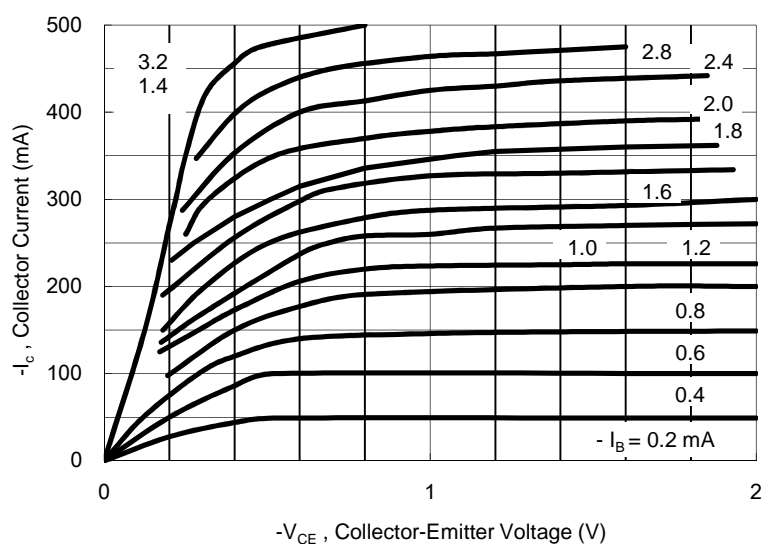
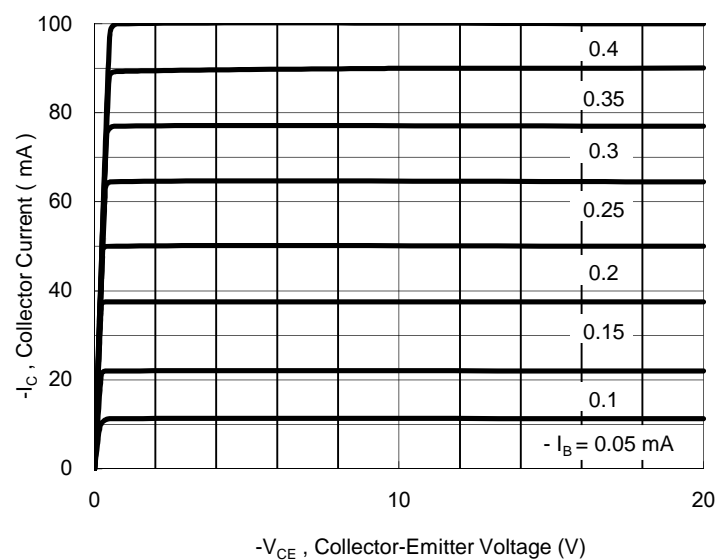

Fig. 6 Typical Emitter-Collector Characteristics



Small Signal Product

ORDERING INFORMATION						
PART NO.	MANUFACTURE CODE	PACKING CODE	GREEN COMPOUND	PACKAGE	PACKING	MARKING
BC807-16	(Note)	RF	G	SOT-23	3K / 7" Reel	5A
BC807-25		RF	G	SOT-23	3K / 7" Reel	5B
BC807-40		RF	G	SOT-23	3K / 7" Reel	5C

Note: Manufacture special control, if empty means no special control requirement.

EXAMPLE					
PREFERRED P/N	PART NO.	MANUFACTURE CODE	PACKING CODE	GREEN COMPOUND CODE	DESCRIPTION
BC807-16 RFG	BC807-16W		RF	G	Green compound
BC807-16-B0 RFG	BC807-16W	B0	RF	G	Green compound
BC807-16-D0 RFG	BC807-16W	D0	RF	G	Green compound

Small Signal Product

DIMENSIONS

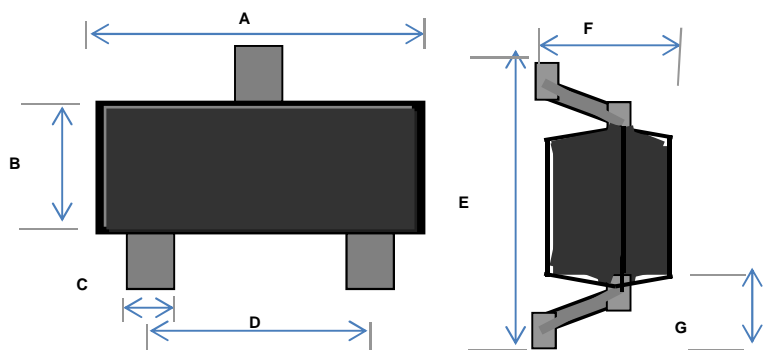

DIM.	Unit (mm)		Unit (inch)	
	Min	Max	Min	Max
A	2.70	3.10	0.106	0.122
B	1.10	1.50	0.043	0.059
C	0.30	0.51	0.012	0.020
D	1.78	2.04	0.070	0.080
E	2.10	2.64	0.083	0.104
F	0.89	1.30	0.035	0.051
G	0.55 REF		0.022 REF	
H	0.1 REF		0.004 REF	

SUGGEST PAD LAYOUT

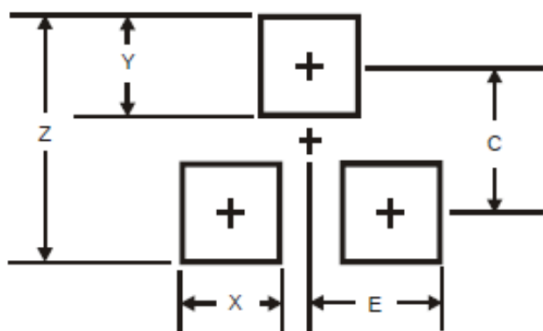

DIM.	Unit (mm)	Unit (inch)
	Typ.	Typ.
A	0.95	0.037
B	2.0	0.079
C	0.9	0.035
D	0.8	0.031

Small Signal Product**Notice**

Specifications of the products displayed herein are subject to change without notice. TSC or anyone on its behalf, assumes no responsibility or liability for any errors in accuracies.

Information contained herein is intended to provide a product description only. No license, express or implied, to any intellectual property rights is granted by this document. Except as provided in TSC's terms and conditions of sale for such products, TSC assumes no liability whatsoever, and disclaims any express or implied warranty, relating to sale and/or use of TSC products including liability or warranties relating to fitness for a particular purpose, merchantability, or infringement of any patent, copyright, or other intellectual property right.

The products shown herein are not designed for use in medical, life-saving, or life-sustaining applications. Customers using or selling these products for use in such applications do so at their own risk and agree to fully indemnify TSC for any damages resulting from such improper use or sale.