



**RoHS Directive compatibility information**  
<http://www.nais-e.com/>

**Features**

**1. Economic pricing that promptly reflects market demands**

Remarkable economic pricing is implemented in pursuit of cost performance.

**2. Output contacts switchable between timed out 2C and timed out 1C/Instantaneous 1C**

The timed out 1C/Instantaneous 1C output contact enables the efficient addition of self-maintenance circuits.

**3. 4 different time ranges selectable on a single unit**

Five types of timers cover the full range of time settings from 1 second to 30 hours.

**4. Equipped with zero-setting instantaneous output**

Set the dial all the way to "0" for instantaneous operation, so circuit testing can be easily accomplished.

**5. Compliant with UL, c-UL and CE.**

**Product types**

Type	//////	Contact arrangement	Time range	Operating voltage	Part No.
PM4S Multi-range Timer A type	Power ON-delay	T.D.: Timed-out 2C INST.: Timed-out 1C Instantaneous 1C (Selected by front switch)	1s/10s/1min/10min (4 time ranges selectable)	100 to 120V AC	PM4S-A2C10M-AC120V
				200 to 240V AC	PM4S-A2C10M-AC240V
				12V DC	PM4S-A2C10M-DC12V
				24V DC	PM4S-A2C10M-DC24V
PM4S Multi-range Timer B type			3s/30s/3min/30min (4 time ranges selectable)	100 to 120V AC	PM4S-A2C30M-AC120V
				200 to 240V AC	PM4S-A2C30M-AC240V
				12V DC	PM4S-A2C30M-DC12V
				24V DC	PM4S-A2C30M-DC24V
PM4S Multi-range Timer C type			6s/60s/6min/60min (4 time ranges selectable)	100 to 120V AC	PM4S-A2C60M-AC120V
				200 to 240V AC	PM4S-A2C60M-AC240V
				12V DC	PM4S-A2C60M-DC12V
				24V DC	PM4S-A2C60M-DC24V
PM4S Multi-range Timer D type	1min/10min/1h/10h (4 time ranges selectable)	100 to 120V AC	PM4S-A2C10H-AC120V		
		200 to 240V AC	PM4S-A2C10H-AC240V		
		12V DC	PM4S-A2C10H-DC12V		
		24V DC	PM4S-A2C10H-DC24V		
PM4S Multi-range Timer E type	3min/30min/3h/30h (4 time ranges selectable)	100 to 120V AC	PM4S-A2C30H-AC120V		
		200 to 240V AC	PM4S-A2C30H-AC240V		
		12V DC	PM4S-A2C30H-DC12V		
		24V DC	PM4S-A2C30H-DC24V		

**Parts name**

• The PM4S Multi-Range timer allows time units and output contacts to be selected via front switches.

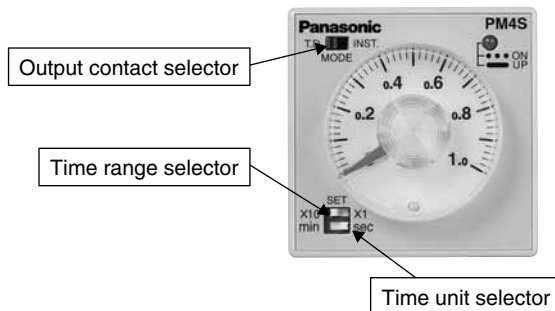

# PM4S

## Specifications

Item		Type	PM4S Multi-range Timer					
Rating	Rated operating voltage		100 to 120V AC		200 to 240V AC	12V DC	24V DC	
	Rated frequency		50/60 Hz				—	
	Rated power consumption		Approx. 3.0VA/3.6VA (at 100V AC) Approx. 4.5VA/5.25VA (at 120V AC)	Approx. 5.6VA/6.8VA (at 200V AC) Approx. 7.5VA/9.8VA (at 240V AC)	Approx. 1.3W		Approx. 1.7W	
	Output rating		5A 250V AC (resistive load)					
	Operating mode		Power ON-delay					
	Time range	A type		1s/10s/1min/10min (4 time ranges selectable)				
		B type		3s/30s/3min/30min (4 time ranges selectable)				
C type			6s/60s/6min/60min (4 time ranges selectable)					
D type			1min/10min/1h/10h (4 time ranges selectable)					
E type			3min/30min/3h/30h (4 time ranges selectable)					
Time accuracy Note)	Operating time fluctuation		±1% (power off time change at the range of 0.1s to 1h)					
	Setting error		±5% (Full-scale value)					
	Voltage error		±1% (at the operating voltage changes between 85 to 110%)					
	Temperature error		±2% (at 20°C ambient temp. at the range of -10 to +50°C +14 to +122°F)					
Contact	Contact arrangement		T.D.: Timed-out 2 Form C INST.: Timed-out 1 Form C, instantaneous 1 Form C (Selected by front switch)					
	Contact resistance (Initial value)		Max. 100mΩ (at 1A 6V DC)					
	Contact material		Silver alloy					
Life	Mechanical (contact)		Min. 10 <sup>7</sup>					
	Electrical (contact)		Min. 10 <sup>5</sup> (at rated control capacity)					
Electrical function	Allowable operating voltage range		85 to 110% of rated operating voltage					
	Insulation resistance (Initial value)		Min. 100MΩ	Between live and dead metal parts Between input and output Between contacts of different poles Between contacts of same pole			(At 500V DC)	
	Breakdown voltage (Initial value)		2,000Vrms for 1 min Between live and dead metal parts 2,000Vrms for 1 min Between input and output 2,000Vrms for 1 min Between contacts of different poles 1,000Vrms for 1 min Between contacts of same pole					
	Min. power off time		100 ms					
	Max. temperature rise		55°C 131°F					
Mechanical function	Vibration resistance	Functional	10 to 55Hz: 1 cycle/min double amplitude of 0.25mm (10min on 3 axes)					
		Destructive	10 to 55Hz: 1 cycle/min double amplitude of 0.375mm (1h on 3 axes)					
	Shock resistance	Functional	Min. 98m/s <sup>2</sup> (4 times on 3 axes)					
		Destructive	Min. 980m/s <sup>2</sup> (5 times on 3 axes)					
Operating condition	Ambient temperature		-10 to +50°C +14 to +122°F					
	Ambient humidity		30 to 85%RH (non-condensing)					
	Atmospheric pressure		860 to 1,060hPa					
	Ripple factor (DC type)		20%					
Others	Weight		Approximately 110 g 3.880 oz					

Notes) 1. Unless otherwise specified, the measurement conditions at the maximum scale time standard are specified to be the rated operating voltage (within 5% ripple factor for DC), 20°C 68°F ambient temperature, and 1s power off time.

2. For the 1s range, the tolerance for each specification becomes ±10ms.

## Applicable standard

Safety standard	EN61812-1	Pollution Degree 2/Overvoltage Category III
EMC	(EMI)EN61000-6-4 Radiation interference electric field strength Noise terminal voltage	EN55011 Group1 ClassA EN55011 Group1 ClassA
	(EMS)EN61000-6-2 Static discharge immunity	EN61000-4-2 4 kV contact 8 kV air
	RF electromagnetic field immunity	EN61000-4-3 10 V/m AM modulation (80 MHz to 1 GHz) 10 V/m pulse modulation (895 MHz to 905 MHz)
	EFT/B immunity	EN61000-4-4 2 kV (power supply line)
	Surge immunity	EN61000-4-5 1 kV (power line)
	Conductivity noise immunity	EN61000-4-6 10 V/m AM modulation (0.15 MHz to 80 MHz)
	Power frequency magnetic field immunity	EN61000-4-8 30 A/m (50 Hz)
	Voltage dip/Instantaneous stop/Voltage fluctuation immunity	EN61000-4-11 10 ms, 30% (rated voltage) 100 ms, 60% (rated voltage) 1,000 ms, 60% (rated voltage) 5,000 ms, 95% (rated voltage)

**Dimension** (Unit: mm inch) Tolerance:  $\pm 0.5 \pm .020$

• **Surface mount dimensions**

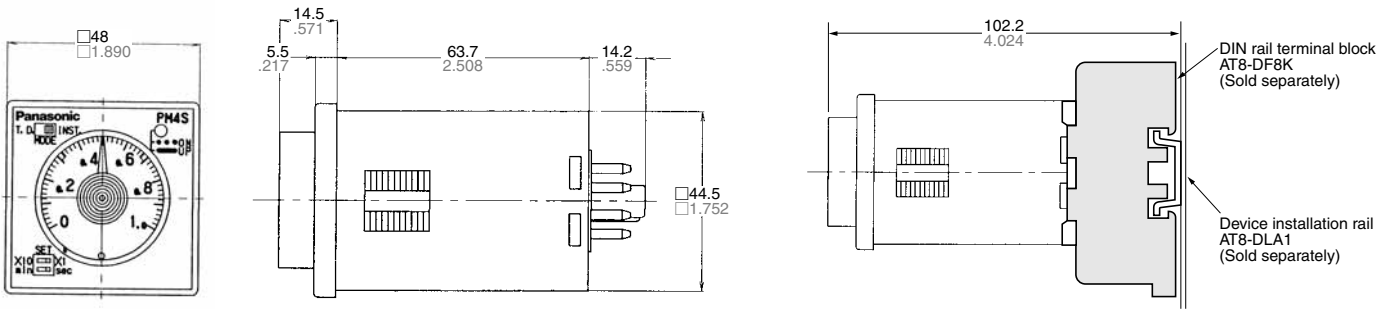

• **Panel mount dimensions (with mounting frame)**

• **Panel cut out dimensions**

Standard cut out dimensions are shown below.

Use mounting frame (AT8-DA4) and rubber gasket (ATC18002).

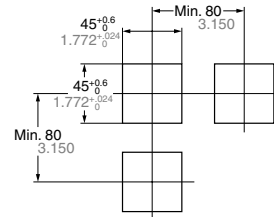
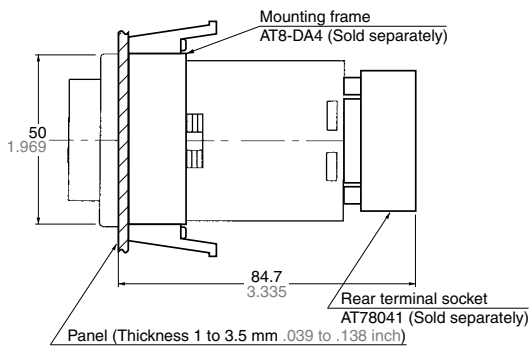

• **Adjacent mounting**

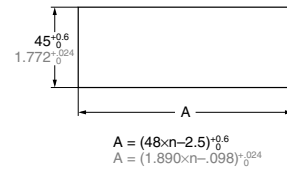

• **Terminal layouts and wiring diagrams**

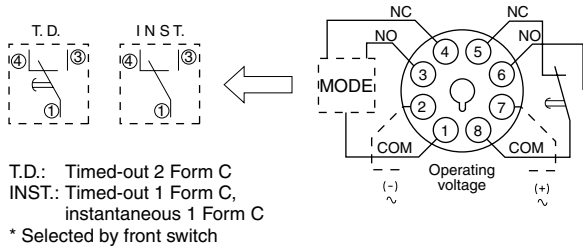

Notes:

1. Operating voltage signs in parentheses ( ) indicate the polarity of the DC type.

2. is a time delay contact.

is an instantaneous contact.

**Operation mode**

1. **T.D. mode**

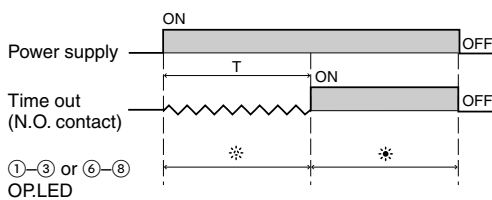

2. **INST. mode**

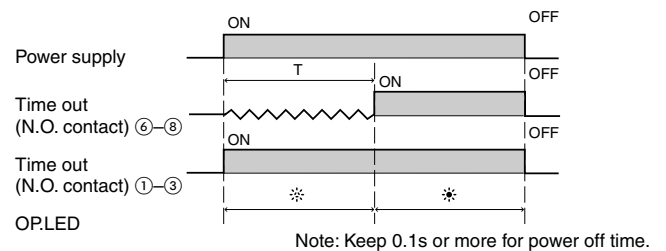

## Precautions during usage

1. Avoid locations subject to flammable or corrosive gases, excessive dust, oil, vibrations, or excessive shocks.
2. Since the main-unit is made of polycarbonate resin, avoid contact with or use in environments containing methyl alcohol, benzene, thinners, and other organic solvents; and ammonia, caustic sodas, and other alkaline substances.
3. **Power supply superimposed surge protector**

Although a surge protector will withstand standard-waveform voltage with the values in the next table, anything above this will destroy the internal circuit. You should therefore use a surge absorber.

12 V DC 24 V DC	100 to 120 V AC 200 to 240 V AC
500 V	4,000 V

- Surge waveform  
[ $\pm(1.2 \times 50) \mu\text{s}$  uni-polar full wave voltage]

4. In order to maintain the characteristics, do not remove the timer case.
5. When installing the panel, use the ATA4811 mounting frame (Sold separately).
6. If you change the operating voltage, be sure not to allow leak current into the timer.
7. Avoid leaving the unit powered continuously. Leaving the unit powered up with output set to ON continuously for a long period of time (about 1 month or more) will wear out the electronic components. If you will be keeping it powered continuously, combine with a relay to create the circuit shown below:

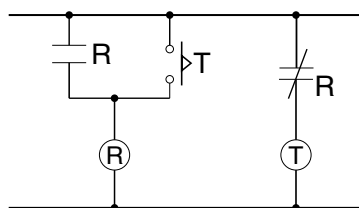

8. The timer setting dial should only be turned within the range indicated on the dial face. Turning it too far may break the stopper and cause damage to internal components.

## Acquisition of CE marking

Please abide by the conditions below when using in applications that comply with EN61812-1.

1. Overvoltage category III, pollution level 2
2. The load connected to the output contact should have basic insulation. This timer is protected with basic insulation and can be double-insulated to meet EN/IEC requirements by using basic insulation on the load.

3. Please use a power supply that is protected by an overcurrent protection device which complies with the EN/IEC standard (example: 250 V 1 A fuse, etc.).
4. You must use a terminal socket or socket for the installation. Do not touch the terminals or other parts of the timer when it is powered. When installing or un-installing, make sure that no voltage is being applied to any of the terminals.

5. Do not use this timer as a safety circuit. For example when using a timer in a heater circuit, etc., provide a protection circuit on the machine side.

**DIN48 SIZE  
MULTI-RANGE  
ANALOG TIMER**

**PM4H-A  
PM4H-S  
PM4H-M**

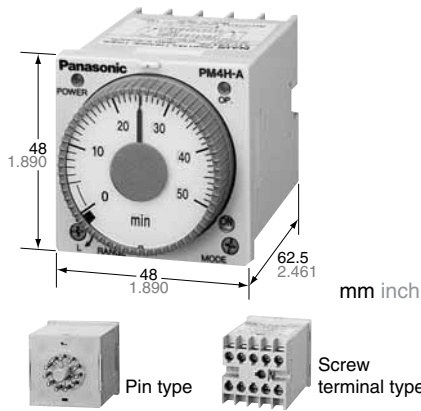

UL File No.: E122222  
CSA File No.: LR39291



**Features**

- 100-240V AC free-voltage input, 48-125V DC type available
- Short body — 62.5mm 2.461 inch (screw terminal type)
- Front panel of IP65 type is protected against water-splash and dust
- Built-in Screw terminals  
Screw terminal type is used for easy wiring and reducing additional cost for accessories.
- 0 setting instantaneous output operation
- Multiple time ranges — 1 s to 500 h (Max.)
- 8 different operation modes: (PM4H-A)
- Compliant with UL/CSA, CE and LLOYD

RoHS Directive compatibility information  
<http://www.nais-e.com/>

**Product types**

Type	Operation mode	Contact arrangement	Time range	Protective construction	Rated operating voltage	Terminal type	Part number
PM4H-A	8 operation modes • Pulse ON-delay • Pulse Flicker • Pulse ON-flicker • Differential ON/OFF-delay (1) (2) • Signal OFF-delay • Pulse One-shot • Pulse One-cycle	Relay Timed-out 2 Form C		IP65	100 to 240V AC	11 pins	PM4HA-H-AC240VW
						Screw terminal	PM4HA-H-AC240VSW
					48 to 125V DC	11 pins	PM4HA-H-DC125VW
						Screw terminal	PM4HA-H-DC125VSW
					24V AC/DC	11 pins	PM4HA-H-24VW
						Screw terminal	PM4HA-H-24VSW
					12V DC	11 pins	PM4HA-H-DC12VW
						Screw terminal	PM4HA-H-DC12VSW
PM4H-S	Power ON-delay	Relay Timed-out 2 Form C	16 selectable ranges 1s to 500h	IP65	100 to 240V AC	11 pins	PM4HA-H-AC240V
						Screw terminal	PM4HA-H-AC240VS
					48 to 125V DC	11 pins	PM4HA-H-DC125VS
						Screw terminal	PM4HA-H-DC125V
					24V AC/DC	11 pins	PM4HA-H-24V
						Screw terminal	PM4HA-H-24VS
					12V DC	11 pins	PM4HA-H-DC12V
						Screw terminal	PM4HA-H-DC12VS
PM4H-M	5 operation modes (With instantaneous contact) • Power ON-delay • Power Flicker • Power ON-flicker • Power One-shot • Power One-cycle	Relay Timed-out 1 Form C Instantaneous 1 Form C		IP65	100 to 240V AC	8 pins	PM4HS-H-AC240VW
						Screw terminal	PM4HS-H-AC240VSW
					48 to 125V DC	8 pins	PM4HS-H-DC125VW
						Screw terminal	PM4HS-H-DC125VSW
					24V AC/DC	8 pins	PM4HS-H-24VW
						Screw terminal	PM4HS-H-24VSW
					12V DC	8 pins	PM4HS-H-DC12VW
						Screw terminal	PM4HS-H-DC12VSW
				IP50	100 to 240V AC	8 pins	PM4HS-H-AC240V
						Screw terminal	PM4HS-H-AC240VS
					48 to 125V DC	8 pins	PM4HS-H-DC125V
						Screw terminal	PM4HS-H-DC125VS
					24V AC/DC	8 pins	PM4HS-H-24V
						Screw terminal	PM4HS-H-24VS
					12V DC	8 pins	PM4HS-H-DC12V
						Screw terminal	PM4HS-H-DC12VS
IP65	100 to 240V AC	8 pins	PM4HM-H-AC240VW				
		Screw terminal	PM4HM-H-AC240VSW				
	48 to 125V DC	8 pins	PM4HM-H-DC125VW				
		Screw terminal	PM4HM-H-DC125VSW				
	24V AC/DC	8 pins	PM4HM-H-24VW				
		Screw terminal	PM4HM-H-24VSW				
	12V DC	8 pins	PM4HM-H-DC12VW				
		Screw terminal	PM4HM-H-DC12VSW				
IP50	100 to 240V AC	8 pins	PM4HM-H-AC240V				
		Screw terminal	PM4HM-H-AC240VS				
	48 to 125V DC	8 pins	PM4HM-H-DC125V				
		Screw terminal	PM4HM-H-DC125VS				
	24V AC/DC	8 pins	PM4HM-H-24V				
		Screw terminal	PM4HM-H-24VS				
	12V DC	8 pins	PM4HM-H-DC12V				
		Screw terminal	PM4HM-H-DC12VS				

If you use this timer under harsh environment, please order above sealed type (IP65 type). IP65 type — Protection dust and water jet splay on the front face.

# PM4H-A/S/M

## Time range

Scale		Time unit			
		sec	min	hrs	10h
1	Control time range	0.1s to 1s	0.1 min to 1 min	0.1h to 1h	1.0h to 10h
5		0.5s to 5s	0.5 min to 5 min	0.5h to 5h	5h to 50h
10		1.0s to 10s	1.0 min to 10 min	1.0h to 10h	10h to 100h
50		5s to 50s	5 min to 50 min	5h to 50h	50h to 500h

PM4H-A/PM4H-S/PM4H-M  
All types of PM4H timer have multi-time range.  
16 time ranges are selectable.  
1s to 500h (Max. range) is controlled.

Note: 0 setting is for instantaneous output operation.

## Specifications

Item	Type	PM4H-A	PM4H-S	PM4H-M
Rating	Rated operating voltage	100 to 240V AC, 48 to 125V DC, 12V DC, 24V AC/DC		
	Rated frequency	50/60Hz common (AC operating type)		
	Rated power consumption	Approx. 10VA (100 to 240V AC) Approx. 2.5VA (24V AC) Approx. 1.5W (12V DC, 24V DC, 48 to 125V DC)		
	Rated control capacity	5A 250V AC (resistive load)		
	Operating mode	Pulse ON-delay Pulse Flicker Pulse ON-Flicker Differential ON/OFF-delay (1) (2) Signal OFF-delay Pulse One-shot Pulse One-cycle	Power ON-delay	Power ON-delay Power Flicker Power ON-flicker Power One-shot Power One-cycle (with instantaneous contact)
	Time range	1s to 500h (Max.) 16 time ranges switchable		
Time accuracy (Note:)	Operating time fluctuation	±0.3% (power off time change at the range of 0.1s to 1h)		
	Setting error	±5% (Full-scale value)		
	Voltage error	±0.5% (at the operating voltage changes between 85 to 110%)		
	Temperature error	±2% (at 20°C ambient temp. at the range of -10 to +50°C +14 to +122°F)		
Contact	Contact arrangement	Timed-out 2 Form C		Timed-out 1 Form C Instantaneous 1 Form C
	Contact resistance (Initial value)	Max. 100mΩ (at 1A 6V DC)		
	Contact material	Silver alloy		Au flash on Silver alloy
Life	Mechanical (contact)	2×10 <sup>7</sup>		
	Electrical (contact)	10 <sup>5</sup> (at rated control capacity)		
Electrical function	Allowable operating voltage range	85 to 110% of rated operating voltage (at 20°C coil temp.)		
	Insulation resistance (Initial value)	Min. 100MΩ	Between live and dead metal parts Between input and output Between contacts of different poles Between contacts of same pole	(At 500V DC)
	Breakdown voltage (Initial value)	2,000Vrms for 1 min Between live and dead metal parts 2,000Vrms for 1 min Between input and output 2,000Vrms for 1 min Between contacts of different poles 1,000Vrms for 1 min Between contacts of same pole		
	Min. power off time	100ms		
	Max. temperature rise	55°C 131°F		65°C 149°F
Mechanical function	Vibration resistance	Functional	10 to 55Hz: 1 cycle/min double amplitude of 0.25mm (10min on 3 axes)	
		Destructive	10 to 55Hz: 1 cycle/min double amplitude of 0.375mm (1h on 3 axes)	
	Shock resistance	Functional	Min. 98m/s <sup>2</sup> (4 times on 3 axes)	
		Destructive	Min. 980m/s <sup>2</sup> (5 times on 3 axes)	
Operating condition	Ambient temperature	-10 to +50°C +14 to +122°F		
	Ambient humidity	30 to 85%RH (at 20°C 68°F, non-condensing)		
	Atmospheric pressure	860 to 1,060hPa		
	Ripple factor (DC type)	20%		
Others	Protective construction	IP65 on front panel (using rubber gasket ATC18002) <only for IP65 type>		
	Weight	100g 3.527 oz (Pin type) 110g 3.880 oz (Screw terminal type)		

Note: 1) Unless otherwise specified, the measurement conditions at the maximum scale time standard are specified to be the rated operating voltage (within 5% ripple factor for DC), 20°C 68°F ambient temperature, and 1s power off time.

2) For the 1s range, the tolerance for each specification becomes ±10ms.

## Terminal layouts and Wiring diagrams

### PM4H-A

Pin type

- Timed-out 2 Form C

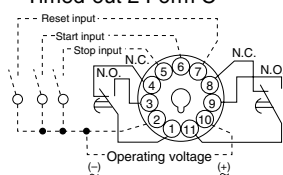

Screw terminal type

- Timed-out 2 Form C

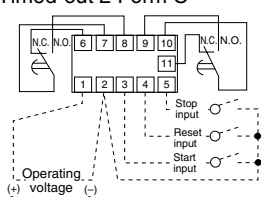

### PM4H-S

Pin type

- Timed-out 2 Form C

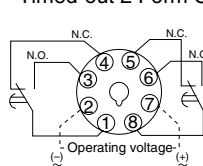

Screw terminal type

- Timed-out 2 Form C

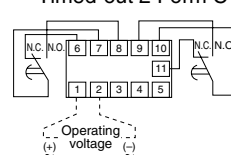

### PM4H-M

Pin type

- Timed-out 1 Form C
- Instantaneous 1 Form C

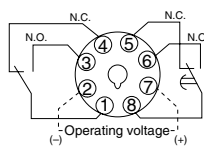

Screw terminal type

- Timed-out 1 Form C
- Instantaneous 1 Form C

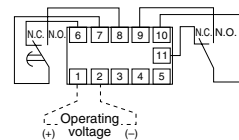

### 1) DC Type

Type	Pin	Screw terminal
PM4H-A	Connect the terminal ② to negative (-), and the terminal ⑩ to positive (+).	Connect the terminal ② to negative (-), and the terminal ① to positive (+).
PM4H-S	Connect the terminal ② to negative (-), and the terminal ⑦ to positive (+).	
PM4H-M	Connect the terminal ② to negative (-), and the terminal ⑦ to positive (+).	

### 2) Contact



- 3) Voltage should not be applied to the various inputs (reset, start, and stop) of the PM4H-A multi-range timer. These inputs should be input without voltage.

## Parts name

### PM4H-S



- Time range selector  
16 time settings selectable  
(1 s to 500 h)  
1s 5s 10s 50s  
1min 5min 10min 50min  
1h 5h 10h 50h  
10h 50h 100h 500h

### PM4H-A

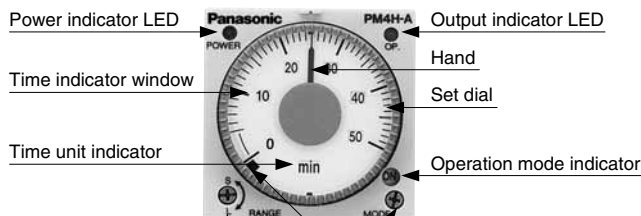

Instantaneous output area  
When the hand is in this area,  
instantaneous operation starts.

- Operation mode selector  
Selectable from 8 operation modes  
ON : Pulse ON-delay  
FL : Pulse Flicker  
FO : Pulse ON-flicker  
OF1 : Differential ON/OFF-delay (1)  
SF : Signal OFF-delay  
OS : Pulse One-shot  
OF2 : Differential ON/OFF-delay (2)  
OC : Pulse One-cycle

### PM4H-M



- Operation mode selector  
Selectable from  
5 operation modes  
ON : Power ON-delay  
FL : Power flicker  
FO : Power ON-flicker  
OS : Power One-shot  
OC : Power One-cycle

# PM4H-A/S/M

## Dimensions

mm inch  
Tolerance:  $\pm 0.5 \pm 0.020$

### • PM4H-□

Screw terminal type  
(Flush mount)

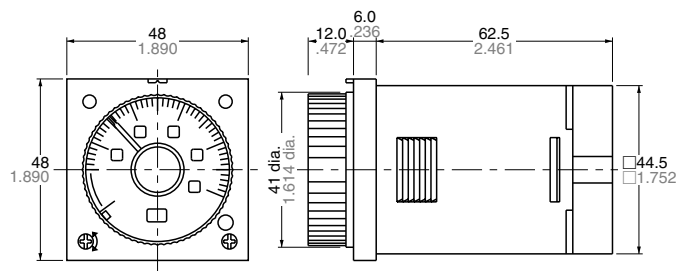

Pin type  
(Flush mount/Surface mount)

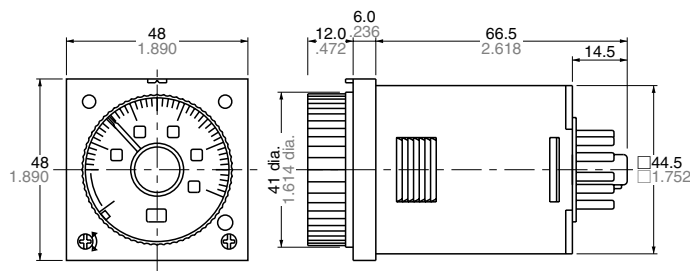

### • Panel mount dimensions (with mounting frame)

Screw terminal type

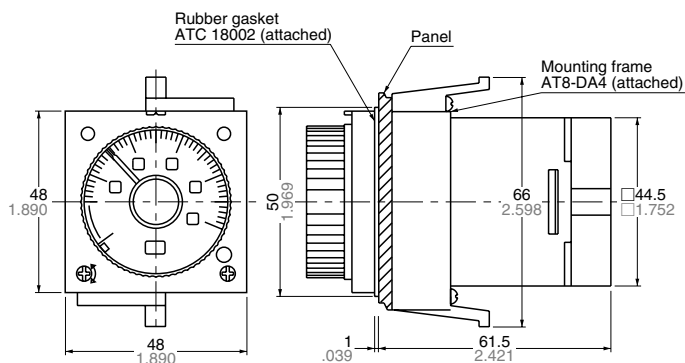

Pin type

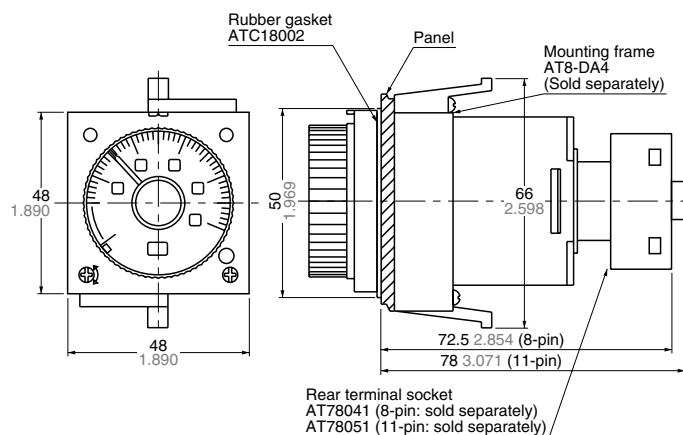

### • Surface mount dimensions

Pin type

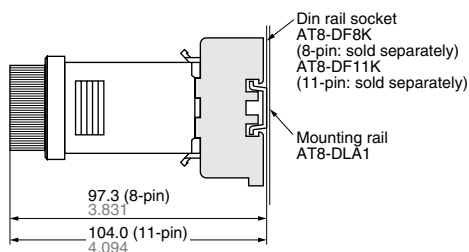

### • Panel cut out dimensions

Standard cut out dimensions are shown below.  
Use mounting frame (AT8-DA4) and rubber gasket (ATC18002).

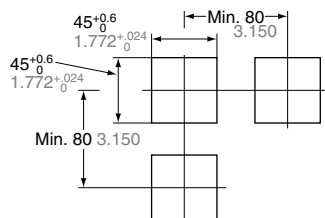

### • Adjacent mounting

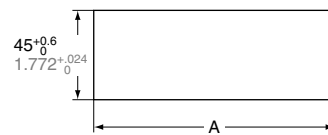

$$A = (48 \times n - 2.5) \pm 0.6$$

$$A = (1.890 \times n - .098) \pm 0.024$$

- Note) 1. The proper thickness of mounting panel is between 1 to 5mm.  
2. Adjacent mount is less water-resistant.



# Operation mode

## PM4H-A

( \* LED lighting ✱ LED flickering  
T: Setting time  $t_1, t_2, t_a, t_b < T$   $t_1 + t_2 = T$  )

Operation type	Explanation	Time chart
<p><b>Pulse ON-delay</b> ⓄN</p>	<ul style="list-style-type: none"> <li>• If using a time-limit start when the power is turned on, and a reset when the power is turned off, pins ② to ⑥ (screw-tightening pins ② and ③) should be shorted ahead of time.</li> <li>• Turn the operation mode selector switch to the ⓄN position.</li> <li>• If pins ② to ⑥ (screw-tightening pins ② and ③) are shorted (the start input is turned on) with the power supply on, the output will go on after the set time has elapsed.</li> <li>• If the power supply is turned off, or pins ② to ⑦ (screw-tightening pins ② to ④) are shorted (the reset input is turned on), a reset is carried out.</li> <li>• Note) During time-limited operation, the time-limited operation is stopped while the pins ② to ⑤ (screw-tightening pins ② to ⑤) are being shorted (the stop input is on). When the pins are released, time-limited operation resumes.</li> </ul>	<p>△Note: * LED lighting or No LED lighting</p>
<p><b>Pulse Flicker</b> ⓄFL</p>	<ul style="list-style-type: none"> <li>• If using a time-limit start when the power is turned on, and a reset when the power is turned off, pins ② to ⑥ (screw-tightening pins ② and ③) should be shorted ahead of time.</li> <li>• Turn the operation mode selector switch to the ⓄFL position.</li> <li>• When pins ② to ⑥ (screw-tightening pins ② and ③) are shorted (the start input is turned on) with the power supply on, the limited time interval begins, and the output goes on after the set time has elapsed. After the output has gone on, it goes off when the set time has elapsed, and this process is subsequently repeated.</li> <li>• If the power supply is turned off, or pins ② to ⑦ (screw-tightening pins ② to ④) are shorted (the reset input is turned on), a reset is carried out.</li> <li>• Note) During time-limited operation, the time-limited operation is stopped while the pins ② to ⑤ (screw-tightening pins ② to ⑤) are being shorted (the stop input is on). When the pins are released, time-limited operation resumes.</li> </ul>	<p>△Note: * LED lighting or No LED lighting</p>
<p><b>Pulse ON-flicker</b> ⓄFO</p>	<ul style="list-style-type: none"> <li>• If using a time-limit start when the power is turned on, and a reset when the power is turned off, pins ② to ⑥ (screw-tightening pins ② and ③) should be shorted ahead of time.</li> <li>• Turn the operation mode selector switch to the ⓄFO position.</li> <li>• When pins ② to ⑥ (screw-tightening pins ② and ③) are shorted (the start input is turned on) with the power supply on, the output goes on, and after the set time has elapsed, it goes off. This process is subsequently repeated.</li> <li>• If the power supply is turned off, or pins ② to ⑦ (screw-tightening pins ② to ④) are shorted (the reset input is turned on), a reset is carried out.</li> <li>• Note) During time-limited operation, the time-limited operation is stopped while the pins ② to ⑤ (screw-tightening pins ② to ⑤) are being shorted (the stop input is on). When the pins are released, time-limited operation resumes.</li> </ul>	<p>△Note: * LED lighting or No LED lighting</p>
<p><b>Differential ON/OFF-delay (1)</b> ⓄF1</p>	<ul style="list-style-type: none"> <li>• Turn the operation mode selector switch to the ⓄF1 position.</li> <li>• When pins ② to ⑥ (screw-tightening pins ② and ③) are shorted (the start input is turned on) with the power supply on, the output goes on, and after the set time has elapsed, it goes off.</li> <li>• Also, when pins ② to ⑥ are released (the start input goes off), the output goes on, and after the set time has elapsed, it goes off.</li> <li>• If the status of pins ② to ⑥ (screw-tightening pins ② and ③) changes during the time-limit interval (the start input goes from on to off, or from off to on), the time-limit interval is restarted from the point at which the change took place.</li> <li>• If the power supply is turned off, or pins ② to ⑦ (screw-tightening pins ② to ④) are shorted (the reset input is turned on), a reset is carried out.</li> <li>• Note) During time-limited operation, the time-limited operation is stopped while the pins ② to ⑤ (screw-tightening pins ② to ⑤) are being shorted (the stop input is on). When the pins are released, time-limited operation resumes.</li> </ul>	<p>△Note: * LED lighting or No LED lighting</p>
<p><b>Signal OFF-delay</b> ⓄSF</p>	<ul style="list-style-type: none"> <li>• Turn the operation mode selector switch to the ⓄSF position.</li> <li>• When pins ② to ⑥ (screw-tightening pins ② and ③) are shorted (the start input is turned on) with the power supply on, the output goes on, and when pins ② to ④ (screw-tightening pins ② and ③) are released (the start input is turned off), the time limit interval begins. After the set time has elapsed, the output goes off. If start input is entered at any point during the time limit interval, the time limit interval is reset.</li> <li>• Note) During time-limited operation, the time-limited operation is stopped while the pins ② to ⑤ (screw-tightening pins ② to ⑤) are being shorted (the stop input is on). When the pins are released, time-limited operation resumes.</li> </ul>	<p>△Note: * LED lighting or No LED lighting</p>

Note: Keep 0.1s or more for power off time.  
Keep 0.05s or more for start, stop, reset input time.

# PM4H-A/S/M

Operation type	Explanation	Time chart
<b>Pulse One-shot</b> OS	<ul style="list-style-type: none"> <li>If using a time-limit start when the power is turned on, and a reset when the power is turned off, pins ② to ⑥ (screw-tightening pins ② and ③) should be shorted ahead of time.</li> <li>Turn the operation mode selector switch to the OS position. When pins ② to ⑥ (screw-tightening pins ② and ③) are shorted (the start input is turned on) with the power supply on, the output goes on for the set time limit interval.</li> <li>If the power supply is turned off, or pins ② to ⑦ (screw-tightening pins ② to ④) are shorted (the reset input is turned on), a reset is carried out.</li> <li>Note) During time-limited operation, the time-limited operation is stopped while the pins ② to ⑤ (screw-tightening pins ② to ⑤) are being shorted (the stop input is on). When the pins are released, time-limited operation resumes.</li> </ul>	<p>△Note: * LED lighting or No LED lighting</p>
<b>Differential ON/OFF-delay (2)</b> OF2	<ul style="list-style-type: none"> <li>Turn the operation mode selector switch to the OF2 position. When pins ② to ⑥ (screw-tightening pins ② and ③) are shorted (the start input is turned on) with the power supply on, the time limit interval begins, and after the set time interval has elapsed, the output goes on.</li> <li>Also, when pins ② to ⑥ are released (the start input goes off), the time limit interval begins, and after it has elapsed, the output goes off.</li> <li>If the status of pins ② to ⑥ (screw-tightening pins ② and ③) changes during the time-limit interval (the start input goes from on to off, or from off to on), the time limit interval is restarted from the point at which the change took place.</li> <li>If the power supply is turned off, or pins ② to ⑦ (screw-tightening pins ② to ④) are shorted (the reset input is turned on), a reset is carried out.</li> <li>Note) During time-limited operation, the time-limited operation is stopped while the pins ② to ⑤ (screw-tightening pins ② to ⑤) are being shorted (the stop input is on). When the pins are released, time-limited operation resumes.</li> </ul>	<p>△Note: * LED lighting or No LED lighting</p>
<b>Pulse One-cycle</b> OC	<ul style="list-style-type: none"> <li>If using a time-limit start when the power is turned on, and a reset when the power is turned off, pins ② to ⑥ (screw-tightening pins ② and ③) should be shorted ahead of time.</li> <li>Turn the operation mode selector switch to the OC position. When pins ② to ⑥ (screw-tightening pins ② and ③) are shorted (the start input is turned on) with the power supply on, the output goes on after the set time limit interval has elapsed. After it has gone on, it goes off after one pulse (approximately 0.8 seconds).</li> <li>If the power supply is turned off, or pins ② to ⑦ (screw-tightening pins ② to ④) are shorted (the reset input is turned on), a reset is carried out.</li> <li>Note) During time-limited operation, the time-limited operation is stopped while the pins ② to ⑤ (screw-tightening pins ② to ⑤) are being shorted (the stop input is on). When the pins are released, time-limited operation resumes.</li> </ul>	<p>One pulse time (t): Approx. 0.8s                      △Note: * LED lighting or No LED lighting</p>

Note: Keep 0.1s or more for power off time.  
 Keep 0.05s or more for start, stop, reset input time.

## PM4H-S

(\* LED lighting \* LED flickering)  
 T: Setting time

Operation type	Explanation	Time chart
<b>Power ON-delay</b>	Time limit contact relay When the power supply is turned on, the output goes on after the set time interval has elapsed. When the power supply is turned off, a reset is carried out.	

## PM4H-M

Operation type	Explanation	Time chart
<b>Power ON-delay</b> ON <b>Power Flicker</b> FL <b>Power ON-flicker</b> FO <b>Power One-shot</b> OS <b>Power One-cycle</b> OC	Turn the operation mode selector switch to display the various operations. When the power supply is turned on, the time limit interval begins, and operation is carried out. When the power supply is turned off, a reset is carried out.	

Note: Keep 0.1s or more for power off time. PM4H-M timers do not have each input which is start, reset and stop.

# PM4H SERIES MODES AND TIME SETTING

## 1. Operation method

### 1) Operation mode setting [PM4H-A type]

8 operation modes are selectable with operation mode selector.  
Turn the operation mode selector with screw driver.  
Operation mode is shown up through the window above the mode selector. The marks are (ON), (FL), (FO), (OF), (SF), (OS), (PF), (OC).  
Turn the mode selector to the mark until you can check by clicking sound.  
Confirm the mode selector position if it is correct.  
If the position is not stable, the timer might mis-operate.



### 2) Time range setting [PM4H series common]

16 time ranges are selectable between 1s to 500h.  
Turn the time range selector with the screw driver.  
Clockwise turning increases the time range, and Counter-clockwise turning decrease the time range.  
Confirm the range selector position if it is correct.  
If the position is not stable, the timer might mis-operate.



### 3) Time setting [common]

To set the time, turn the set dial to a desired time within the range.  
Instantaneous output will be on when the dial is set to "0".  
When the instantaneous output is used, the dial should be set under "0" range. (Instantaneous output area)  
When power supply is on, the time range, setting time and operation mode cannot be changed.  
Turn off the power supply or a reset signal is applied to set the new operation mode.  
If the position is not stable, the timer might mis-operate.

## 2. How to use "Set ring" [PM4H series common]

### 1) Fixed time setting

Set the desired time and put 2 set rings together.  
Insert the rings into stopper to fix the time.

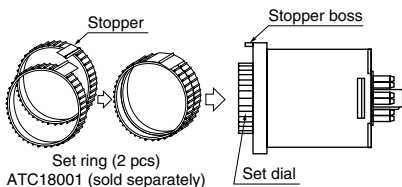

### 2) Time range setting

Example: Time range 20s to 30s.

#### ① Shorter time value setting

Set the dial to 20s.  
Place the stop ring at the right side of stopper.

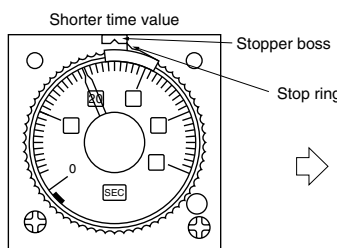

#### ② Longer time value setting

Set the dial to 30s.  
Place the stop ring at the left side of stopper.

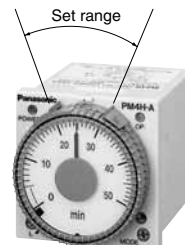
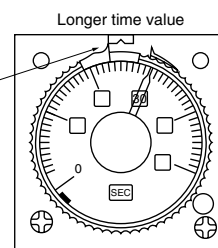

Note) The stoppers for the lower limit setting set ring and the upper limit setting set ring face the opposite directions.

## Applicable standard (PM4H series common)

Safety standard	EN61812-1	Pollution Degree 2/Overvoltage Category III
EMC	(EMI)EN61000-6-4 Radiation interference electric field strength Noise terminal voltage (EMS)EN61000-6-2 Static discharge immunity	EN55011 Group1 ClassA EN55011 Group1 ClassA
	RF electromagnetic field immunity	EN61000-4-2 4 kV contact 8 kV air
	EFT/B immunity	EN61000-4-3 10 V/m AM modulation (80 MHz to 1 GHz) 10 V/m pulse modulation (895 MHz to 905 MHz)
	Surge immunity	EN61000-4-4 2 kV (power supply line) 1 kV (signal line)
	Conductivity noise immunity	EN61000-4-5 1 kV (power line)
	Power frequency magnetic field immunity	EN61000-4-6 10 V/m AM modulation (0.15 MHz to 80 MHz)
	Voltage dip/Instantaneous stop/Voltage fluctuation immunity	EN61000-4-8 30 A/m (50 Hz) EN61000-4-11 10 ms, 30% (rated voltage) 100 ms, 60% (rated voltage) 1,000 ms, 60% (rated voltage) 5,000 ms, 95% (rated voltage)

# Panasonic

ideas for life

## DIN48 SIZE ANALOG STAR (∩)-DELTA (Δ) TIMERS

# PM4H-SD/SDM

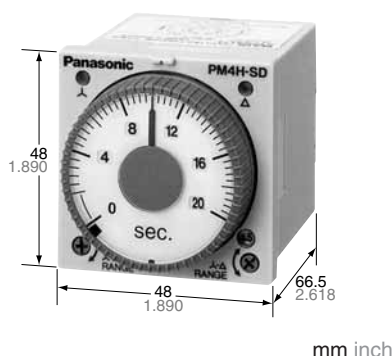

UL File No.: E122222  
CSA File No.: LR39291



### Features

1. Select four types of time ranges between 0.2 s and 100 s on a single unit.
2. Select between five types of time ranges between 0.04 s and 0.7 s for the ∩-Δ switching times.
3. There is a ∩-Δ switching indicator so you can check the operation at a glance.
4. The AC free power supply and shorter body make it easier to use.
5. Compliant with UL, CSA, CE and LLOYD.

RoHS Directive compatibility information  
<http://www.nais-e.com/>

## Specifications

Item	Type	PM4H-SD/SDM	
Rating	Rated operating voltage	100 to 240V AC, 24V AC	
	Rated frequency	50/60Hz common	
	Rated power consumption	Approx. 6VA (100 to 240V AC), Approx. 1.4VA (24V AC)	
	Rated control capacity	5A 250V AC (resistive load)	
	Operation mode	∩-Δ star-delta switching (Power ON-delay)	
	∩ operation control time range	2s to 100s, 4 time ranges switchable	
Time accuracy (Note:)	∩-Δ switching time	0.04, 0.1, 0.3, 0.5, 0.7s (5 time range selectable)	
	Operation time fluctuation	±0.3% (power off time change at the range of 0.5s to 1h)	
	Setting error	±5% (Full-scale value)	
	Voltage error	±0.5% (at the operating voltage changes between 85 to 110%)	
	Temperature error	±2% (at 20°C ambient temp. at the range of -10 to +50°C +14 to +122°F)	
Contact	Contact arrangement	Star (∩) side: Timed-out 1 Form A, Delta (Δ) side: Timed-out 1 Form A Instantaneous: 1 Form A (Instantaneous for PM4H-SDM type only)	
	Contact resistance (Initial value)	Max. 100mΩ (at 1A 6V DC)	
	Contact material	Au flash on Silver alloy	
Life	Mechanical (contact)	2×10 <sup>7</sup>	
	Electrical (contact)	10 <sup>5</sup> (at rated control capacity)	
Electrical function	Allowable operating voltage range	85 to 110% of rated operating voltage (at 20°C coil temp.)	
	Insulation resistance (Initial value)	Min. 100MΩ Between live and dead metal parts Between input and output Between contacts of different poles (*3) (At 500V DC) Between contacts of same pole	
	Breakdown voltage (Initial value)	2,000Vrms for 1 min Between live and dead metal parts 2,000Vrms for 1 min Between input and output 2,000Vrms for 1 min Between contacts of different poles (*3) 1,000Vrms for 1 min Between contacts of same pole	
	Min. power off time	500ms	
	Max. temperature rise	65°C 131°F	
Mechanical function	Vibration resistance	Functional	10 to 55Hz: 1 cycle/min double amplitude of 0.25mm (10min on 3 axes)
		Destructive	10 to 55Hz: 1 cycle/min double amplitude of 0.375mm (1h on 3 axes)
	Shock resistance	Functional	Min. 294m/s <sup>2</sup> (4 times on 3 axes)
		Destructive	Min. 980m/s <sup>2</sup> (5 times on 3 axes)
Operating condition	Ambient temperature	-10 to +50°C +14 to +122°F	
	Ambient humidity	Max. 85%RH (non-condensing)	
	Atmospheric pressure	860 to 1,060hPa	
Others	Protective construction	IP65 on front panel (using rubber gasket ATC18002) <only for IP65 type>	
	Weight	100g 3.527 oz (Pin type), 110g 3.880 oz (Screw terminal type)	

Notes: 1) Unless otherwise specified, the measurement conditions at the maximum scale time standard are specified to be the rated operating voltage, 20°C 68°F ambient temperature, and 1s power off time.

2) For the 2s range, the tolerance for each specification becomes ±10ms.

3) Between contacts of different poles for PM4H-SDM type only.

# PM4H-SD/SDM

## Time range

Time range unit	Operating (s)	△-△ switching time (s)
2	0.2 to 2	0.04
10	1 to 10	0.1
20	2 to 20	0.3
100	10 to 100	0.7

## Product types

Type	Operation mode	Contact arrangement	Time range	Protective construction	Rated operating voltage	Terminal type	Part number
PM4H-SD Star (△)-Delta (△) switching	Star (△)-Delta (△) switching	Relay Timed-out △ side: 1 Form A △ side: 1 Form A	4 selectable ranges over 2s to 100s (△-△ switching time: 0.04, 0.1, 0.3, 0.5, 0.7s)	IP65	100 to 240V AC	8 pins	PM4HSD-S-AC240VW
						Screw terminal	PM4HSD-S-AC240VSW
24V AC		8 pins			PM4HSD-S-AC24VW		
		Screw terminal			PM4HSD-S-AC24VSW		
100 to 240V AC		Relay Timed-out △ side: 1 Form A Instantaneous: 1 Form A			8 pins	PM4HSDM-S-AC240VW	
							Screw terminal
24V AC		8 pins			PM4HSDM-S-AC24VW		
						Screw terminal	PM4HSDM-S-AC24VSW
100 to 240V AC	Relay Timed-out △ side: 1 Form A △ side: 1 Form A	8 pins	PM4HSD-S-AC240V				
				Screw terminal	PM4HSD-S-AC240VS		
24V AC	8 pins	PM4HSD-S-AC24V					
			Screw terminal	PM4HSD-S-AC24VS			
100 to 240V AC	Relay Timed-out △ side: 1 Form A Instantaneous: 1 Form A	8 pins	PM4HSDM-S-AC240V				
				Screw terminal	PM4HSDM-S-AC240VS		
24V AC	8 pins	PM4HSDM-S-AC24V					
			Screw terminal	PM4HSDM-S-AC24VS			

## Terminal layouts and Wiring diagrams

### Pin type

- No instantaneous contact
- With instantaneous contact

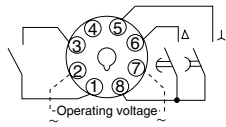
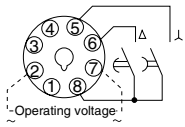

- ⑤-⑧: △ side time-delay contact
- ④-⑧: △ side time-delay contact
- ①-③: Instantaneous contact (PM4H-SDM type)

### Screw terminal type

- No instantaneous contact
- With instantaneous contact

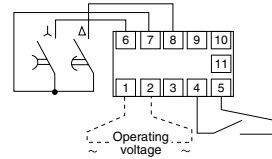
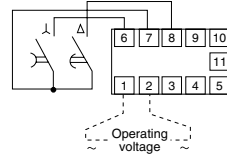

- ⑥-⑦: △ side time-delay contact
- ⑧-⑦: △ side time-delay contact
- ④-⑤: Instantaneous contact (PM4H-SDM type)

## Dimensions

mm inch

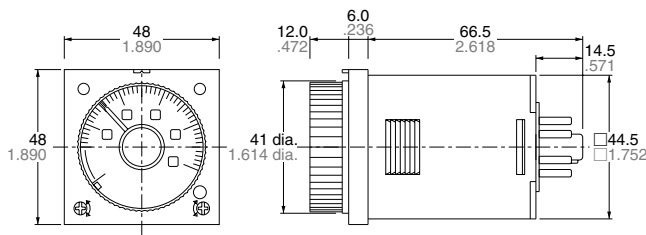

## Operation

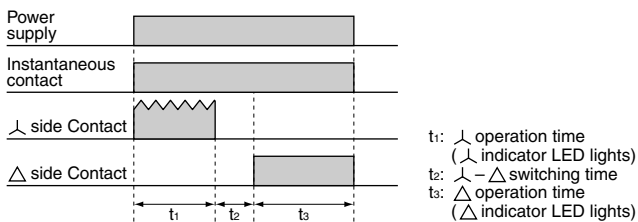

# PM4H SERIES MODES AND TIME SETTING

## 1. Operation method

### 1) Operation mode setting [PM4H-A type]

8 operation modes are selectable with operation mode selector.  
Turn the operation mode selector with screw driver.  
Operation mode is shown up through the window above the mode selector. The marks are (ON), (FL), (FO), (OF), (SF), (OS), (PF), (OC).  
Turn the mode selector to the mark until you can check by clicking sound.  
Confirm the mode selector position if it is correct.  
If the position is not stable, the timer might mis-operate.



### 2) Time range setting [PM4H series common]

16 time ranges are selectable between 1s to 500h.  
Turn the time range selector with the screw driver.  
Clockwise turning increases the time range, and Counter-clockwise turning decrease the time range.  
Confirm the range selector position if it is correct.  
If the position is not stable, the timer might mis-operate.



### 3) Time setting [common]

To set the time, turn the set dial to a desired time within the range.  
Instantaneous output will be on when the dial is set to "0".  
When the instantaneous output is used, the dial should be set under "0" range. (Instantaneous output area)  
When power supply is on, the time range, setting time and operation mode cannot be changed.  
Turn off the power supply or a reset signal is applied to set the new operation mode.  
If the position is not stable, the timer might mis-operate.

## 2. How to use "Set ring" [PM4H series common]

### 1) Fixed time setting

Set the desired time and put 2 set rings together.  
Insert the rings into stopper to fix the time.

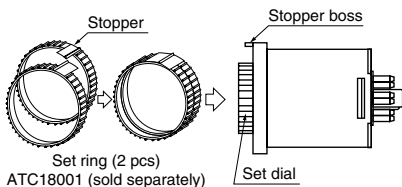

### 2) Time range setting

Example: Time range 20s to 30s.

#### ① Shorter time value setting

Set the dial to 20s.  
Place the stop ring at the right side of stopper.

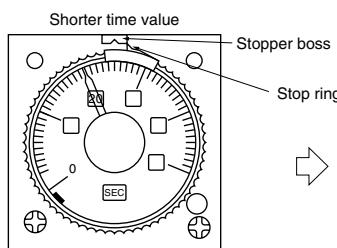

#### ② Longer time value setting

Set the dial to 30s.  
Place the stop ring at the left side of stopper.

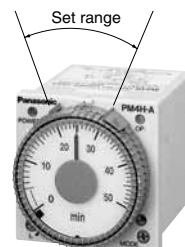
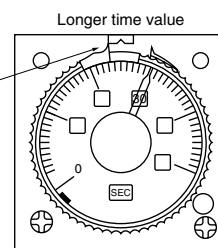

Note) The stoppers for the lower limit setting set ring and the upper limit setting set ring face the opposite directions.

## Applicable standard (PM4H series common)

Safety standard	EN61812-1	Pollution Degree 2/Overvoltage Category III
EMC	(EMI)EN61000-6-4 Radiation interference electric field strength Noise terminal voltage (EMS)EN61000-6-2 Static discharge immunity	EN55011 Group1 ClassA EN55011 Group1 ClassA
	RF electromagnetic field immunity	EN61000-4-2 4 kV contact 8 kV air
	EFT/B immunity	EN61000-4-3 10 V/m AM modulation (80 MHz to 1 GHz) 10 V/m pulse modulation (895 MHz to 905 MHz)
	Surge immunity	EN61000-4-4 2 kV (power supply line) 1 kV (signal line)
	Conductivity noise immunity	EN61000-4-5 1 kV (power line)
	Power frequency magnetic field immunity	EN61000-4-6 10 V/m AM modulation (0.15 MHz to 80 MHz)
	Voltage dip/Instantaneous stop/Voltage fluctuation immunity	EN61000-4-8 30 A/m (50 Hz) EN61000-4-11 10 ms, 30% (rated voltage) 100 ms, 60% (rated voltage) 1,000 ms, 60% (rated voltage) 5,000 ms, 95% (rated voltage)

**Panasonic**  
ideas for life

**DIN48 SIZE ANALOG  
MULTIRANGE POWER  
OFF-DELAY TIMERS**

**PM4H-F**

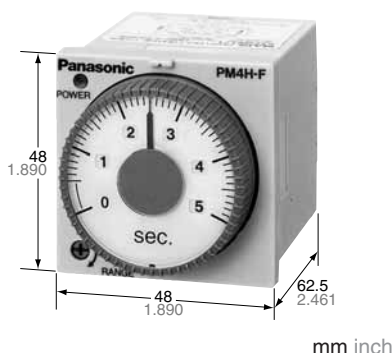

**UL File No.: E122222  
CSA File No.: LR39291**



### Features

1. Switch operation times between three types of time ranges of 1 s to 10 s and 1 min to 10 min.
2. Instantaneous reset available.
3. The shorter body makes it easier to use.
4. Compliant with UL, CSA, CE and LLOYD.

RoHS Directive compatibility information  
<http://www.nais-e.com/>

## Specifications

Item	Type	PM4H-F8	PM4H-F8R	PM4H-F11R
Rating	Rated operating voltage	100 to 120V AC, 200 to 240V AC, 24V DC, 12V DC, 24V DC		
	Rated frequency	50/60Hz common (AC operating type)		
	Rated power consumption	Approx. 1.6VA (100 to 120V AC, 200 to 240V AC), Approx. 2.3VA (24V AC) Approx. 1.1W (12V DC, 24V DC)		
	Rated control capacity	3A 250V AC (resistive load)		
	Operation mode	Power OFF-delay	Power OFF-delay (with reset)	
	Time range	1s to 10s: 3 range switchable 1 min to 10 min: 3 range selectable		
Time accuracy *1	Operation time fluctuation	±0.3%		
	Setting error	±5% (Full-scale value)		
	Voltage error	±0.5% (at the operating voltage changes between 85 to 110%)		
	Temperature error	±2% (at 20°C ambient temp. at the range of -10 to +50°C +14 to +122°F)		
Contact	Contact arrangement	Timed-out 2 Form C	Timed-out 1 Form C	Timed-out 2 Form C
	Contact resistance (Initial value)	Max. 100mΩ (at 1A 6V DC)		
	Contact material	Au flash on Silver alloy		
Life	Mechanical (contact)	10 <sup>7</sup>		
	Electrical (contact)	10 <sup>5</sup> (at rated control capacity)		
Electrical function	Allowable operating voltage range	85 to 110% of rated operating voltage (at 20°C coil temp.), 90 to 110% (DC Type)		
	Insulation resistance (Initial value)	Min. 100MΩ	Between live and dead metal parts Between input and output Between contacts of different poles (*3) (At 500V DC) Between contacts of same pole	
	Breakdown voltage (Initial value)	1,500Vrms for 1 min Between live and dead metal parts 1,500Vrms for 1 min Between input and output 1,000Vrms for 1 min Between contacts of different poles (*3) 750Vrms for 1 min Between contacts of same pole		
	Min. power supply width	s range type: 100ms min range type: 2s		
	Min. reset time	50ms		
	Max. temperature rise	55°C 131°F		
Mechanical function	Vibration resistance	Functional	10 to 55Hz: 1 cycle/min double amplitude of 0.25mm (10min on 3 axes)	
		Destructive	10 to 55Hz: 1 cycle/min double amplitude of 0.375mm (1hr on 3 axes)	
	Shock resistance	Functional	Min. 98m/s <sup>2</sup> (4 times on 3 axes)	
		Destructive	Min. 980m/s <sup>2</sup> (5 times on 3 axes)	
Operating condition	Ambient temperature	-10 to +50°C +14 to +122°F		
	Ambient humidity	30 to 85%RH (non-condensing)		
	Atmospheric pressure	860 to 1,060hPa		
	Ripple factor (DC type)	20%		
Others	Protective construction	IP65 on front panel (using rubber gasket ATC18002) <only for IP65 type>		
	Weight	100g 3.527 oz (Pin type), 110g 3.880 oz (Screw terminal type)		

\*Notes: 1) Unless otherwise specified, the measurement conditions at the maximum scale time standard are specified to be the rated operating voltage (within 5% ripple factor for DC), 20°C 68°F ambient temperature.

2) For the 1s range, the tolerance for each specification becomes ±10ms. When the power goes on, inrush current (0.3A) flows. Cautions should be taken. The minimum power supplying time after forced reset input is 2s or more.

3) Between contacts of different pools for PM4H-F8, PM4H-F11R types only.

# PM4H-F

## Time range

Time range	Time range unit	s range type	min range type
1		0.04s to 1s	0.04 min to 1 min
5		0.2s to 5s	0.2 min to 5 min
10		0.4s to 10s	0.4 min to 10 min

## Product types

Type	Operation mode	Contact arrangement	Time range	Protective construction	Rated operating voltage	Terminal type	Part number
PM4H-F8	Power OFF-delay (without reset)	Relay Timed-out 2 Form C	3 selectable time ranges over 1s to 10s	IP65	100 to 120V AC	8 pins	PM4HF8-S-AC120VW
					200 to 240V AC	8 pins	PM4HF8-S-AC240VW
					24V AC	8 pins	PM4HF8-S-AC24VW
					12V DC	8 pins	PM4HF8-S-DC12VW
					24V DC	8 pins	PM4HF8-S-DC24VW
					100 to 120V AC	8 pins	PM4HF8-M-AC120VW
					200 to 240V AC	8 pins	PM4HF8-M-AC240VW
					24V AC	8 pins	PM4HF8-M-AC24VW
			3 selectable time ranges over 1 min to 10 min	IP65	12V DC	8 pins	PM4HF8-M-DC12VW
					24V DC	8 pins	PM4HF8-M-DC24VW
					100 to 120V AC	8 pins	PM4HF8-S-AC120V
					200 to 240V AC	8 pins	PM4HF8-S-AC240V
					24V AC	8 pins	PM4HF8-S-AC24V
					12V DC	8 pins	PM4HF8-S-DC12V
					24V DC	8 pins	PM4HF8-S-DC24V
					3 selectable time ranges over 1 min to 10 min	IP50	100 to 120V AC
200 to 240V AC	8 pins	PM4HF8-M-AC240V					
24V AC	8 pins	PM4HF8-M-AC24V					
12V DC	8 pins	PM4HF8-M-DC12V					
24V DC	8 pins	PM4HF8-M-DC24V					
100 to 120V AC	8 pins	PM4HF8-S-AC120VW					
200 to 240V AC	8 pins	PM4HF8-S-AC240VW					
24V AC	8 pins	PM4HF8-S-AC24VW					
PM4H-F8R	Power OFF-delay (with instantaneous reset)	Relay Timed-out 1 Form C	3 selectable time ranges over 1s to 10s	IP65	12V DC	8 pins	PM4HF8R-S-DC12VW
					24V DC	8 pins	PM4HF8R-S-DC24VW
					100 to 120V AC	8 pins	PM4HF8R-M-AC120VW
					200 to 240V AC	8 pins	PM4HF8R-M-AC240VW
					24V AC	8 pins	PM4HF8R-M-AC24VW
					12V DC	8 pins	PM4HF8R-M-DC12VW
					24V DC	8 pins	PM4HF8R-M-DC24VW
					3 selectable time ranges over 1 min to 10 min	IP50	100 to 120V AC
			200 to 240V AC	8 pins			PM4HF8R-S-AC240V
			24V AC	8 pins			PM4HF8R-S-AC24V
			12V DC	8 pins			PM4HF8R-S-DC12V
			24V DC	8 pins			PM4HF8R-S-DC24V
			100 to 120V AC	8 pins			PM4HF8R-M-AC120V
			200 to 240V AC	8 pins			PM4HF8R-M-AC240V
			24V AC	8 pins			PM4HF8R-M-AC24V
			3 selectable time ranges over 1 min to 10 min	IP50	12V DC	8 pins	PM4HF8R-M-DC12V
24V DC	8 pins	PM4HF8R-M-DC24V					



Type	Operation mode	Contact arrangement	Time range	Protective construction	Rated operating voltage	Terminal type	Part number
PM4H-F11R	Power OFF-delay (with instantaneous reset)	Relay Timed-out 2 Form C	3 selectable time ranges over 1s to 10s	IP65	100 to 120V AC	11 pins	PM4HF11R-S-AC120VW
						Screw terminal	PM4HF11R-S-AC120VSW
					200 to 240V AC	11 pins	PM4HF11R-S-AC240VW
						Screw terminal	PM4HF11R-S-AC240VSW
					24V AC	11 pins	PM4HF11R-S-AC24VW
						Screw terminal	PM4HF11R-S-AC24VSW
				12V DC	11 pins	PM4HF11R-S-DC12VW	
					Screw terminal	PM4HF11R-S-DC12VSW	
				24V DC	11 pins	PM4HF11R-S-DC24VW	
					Screw terminal	PM4HF11R-S-DC24VSW	
				IP50	100 to 120V AC	11 pins	PM4HF11R-S-AC120V
						Screw terminal	PM4HF11R-S-AC120VS
			200 to 240V AC		11 pins	PM4HF11R-S-AC240V	
					Screw terminal	PM4HF11R-S-AC240VS	
			24V AC		11 pins	PM4HF11R-S-AC24V	
					Screw terminal	PM4HF11R-S-AC24VS	
			12V DC	11 pins	PM4HF11R-S-DC12V		
				Screw terminal	PM4HF11R-S-DC12VS		
			24V DC	11 pins	PM4HF11R-S-DC24V		
				Screw terminal	PM4HF11R-S-DC24VS		
			3 selectable time ranges over 1 min to 10 min	IP65	100 to 120V AC	11 pins	PM4HF11R-M-AC120VW
						Screw terminal	PM4HF11R-M-AC120VSW
					200 to 240V AC	11 pins	PM4HF11R-M-AC240VW
						Screw terminal	PM4HF11R-M-AC240VSW
24V AC	11 pins	PM4HF11R-M-AC24VW					
	Screw terminal	PM4HF11R-M-AC24VSW					
12V DC	11 pins	PM4HF11R-M-DC12VW					
	Screw terminal	PM4HF11R-M-DC12VSW					
24V DC	11 pins	PM4HF11R-M-DC24VW					
	Screw terminal	PM4HF11R-M-DC24VSW					
IP50	100 to 120V AC	11 pins		PM4HF11R-M-AC120V			
		Screw terminal		PM4HF11R-M-AC120VS			
	200 to 240V AC	11 pins	PM4HF11R-M-AC240V				
		Screw terminal	PM4HF11R-M-AC240VS				
	24V AC	11 pins	PM4HF11R-M-AC24V				
		Screw terminal	PM4HF11R-M-AC24VS				
12V DC	11 pins	PM4HF11R-M-DC12V					
	Screw terminal	PM4HF11R-M-DC12VS					
24V DC	11 pins	PM4HF11R-M-DC24V					
	Screw terminal	PM4HF11R-M-DC24VS					

Dimensions

mm inch

Tolerance: ±0.5 ±.020

• Screw terminal type (Flush mount)

• Pin type (Flush mount/surface mount)

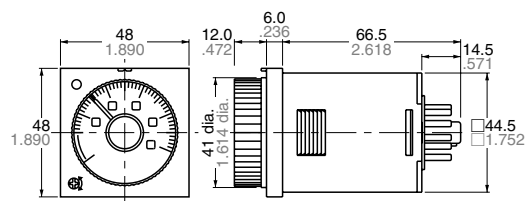
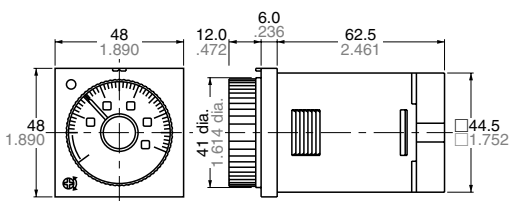

# PM4H-F

## Terminal layouts and Wiring diagrams

- **PM4H-F8 (without reset input)**

Pin type  
Time-out 2 Form C

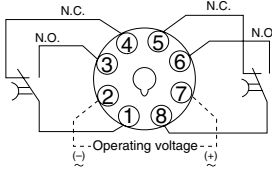

Screw-tightening pin type

The PM4H-F11R should be used for the time-limit 2C.

- **PM4H-F8R (with reset input)**

Pin type  
Time-out 1 Form C, with reset input

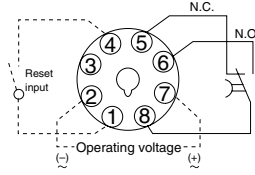

Screw-tightening pin type

The PM4H-F11R should be used for the time-limit 1C and to connect reset input.

- **PM4H-F11R (with reset input)**

Pin type  
Time-out 2 Form C, with reset input

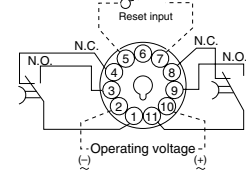

Screw terminal type

Time-out 2 Form C, with reset input

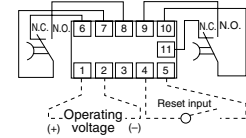

## PM4H-F (with reset) input conditions

### 1. Contact input (pin type example)

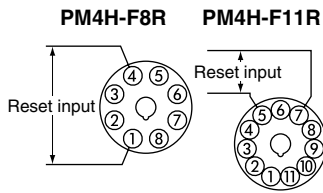

Use a contact with good contact reliability for the input. Contact bounce can lead to erroneous operation of the timer, so use a contact with short bounce time. Make the resistance between terminals for a short circuit less than 1k-ohms. Make the resistance between terminals for an open circuit greater than 100k-ohms.

### 2. Non-contact input (pin type example)

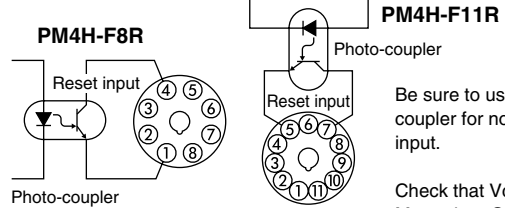

Be sure to use a photo-coupler for non-contact input.

Check that  $V_{ce} = 0.6V$  Max. when ON.

## Operation

- **PM4H-F8 (without reset input)**

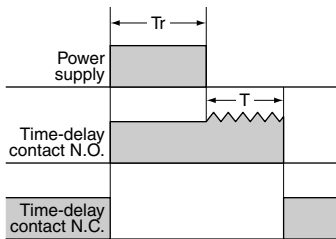

- **PM4H-F8R/F11R (with reset input)**

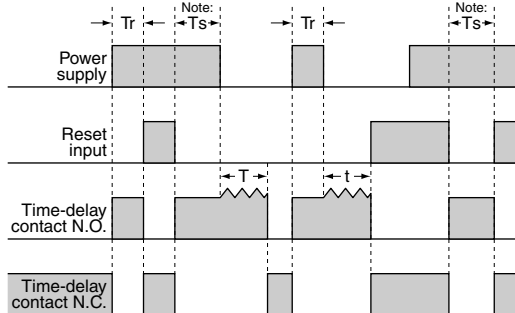

$t_c$ : Time setting

$T_r$ : Minimum power supply application time

Note:  $T_s$ : Min. 2s (Time to restart operation after reset input is set to OFF: both second type and minute type)

# PM4H SERIES MODES AND TIME SETTING

## 1. Operation method

### 1) Operation mode setting [PM4H-A type]

8 operation modes are selectable with operation mode selector.  
Turn the operation mode selector with screw driver.  
Operation mode is shown up through the window above the mode selector. The marks are (ON), (FL), (FO), (OF), (SF), (OS), (PF), (OC).  
Turn the mode selector to the mark until you can check by clicking sound.  
Confirm the mode selector position if it is correct.  
If the position is not stable, the timer might mis-operate.



### 2) Time range setting [PM4H series common]

16 time ranges are selectable between 1s to 500h.  
Turn the time range selector with the screw driver.  
Clockwise turning increases the time range, and Counter-clockwise turning decrease the time range.  
Confirm the range selector position if it is correct.  
If the position is not stable, the timer might mis-operate.



### 3) Time setting [common]

To set the time, turn the set dial to a desired time within the range.  
Instantaneous output will be on when the dial is set to "0".  
When the instantaneous output is used, the dial should be set under "0" range. (Instantaneous output area)  
When power supply is on, the time range, setting time and operation mode cannot be changed.  
Turn off the power supply or a reset signal is applied to set the new operation mode.  
If the position is not stable, the timer might mis-operate.

## 2. How to use "Set ring" [PM4H series common]

### 1) Fixed time setting

Set the desired time and put 2 set rings together.  
Insert the rings into stopper to fix the time.

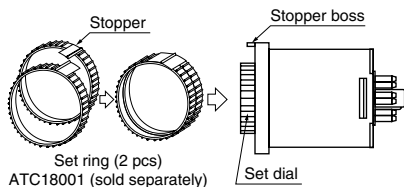

### 2) Time range setting

Example: Time range 20s to 30s.

#### ① Shorter time value setting

Set the dial to 20s.  
Place the stop ring at the right side of stopper.

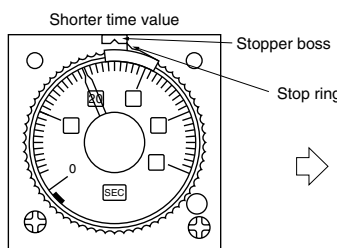

#### ② Longer time value setting

Set the dial to 30s.  
Place the stop ring at the left side of stopper.

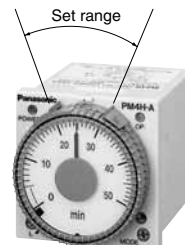
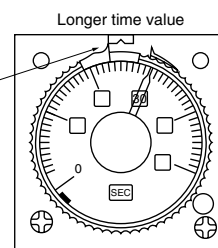

Note) The stoppers for the lower limit setting set ring and the upper limit setting set ring face the opposite directions.

## Applicable standard (PM4H series common)

Safety standard	EN61812-1	Pollution Degree 2/Overvoltage Category III
EMC	(EMI)EN61000-6-4 Radiation interference electric field strength Noise terminal voltage (EMS)EN61000-6-2 Static discharge immunity	EN55011 Group1 ClassA EN55011 Group1 ClassA
	RF electromagnetic field immunity	EN61000-4-2 4 kV contact 8 kV air
	EFT/B immunity	EN61000-4-3 10 V/m AM modulation (80 MHz to 1 GHz) 10 V/m pulse modulation (895 MHz to 905 MHz)
	Surge immunity	EN61000-4-4 2 kV (power supply line) 1 kV (signal line)
	Conductivity noise immunity	EN61000-4-5 1 kV (power line)
	Power frequency magnetic field immunity Voltage dip/Instantaneous stop/Voltage fluctuation immunity	EN61000-4-6 10 V/m AM modulation (0.15 MHz to 80 MHz) EN61000-4-8 30 A/m (50 Hz) EN61000-4-11 10 ms, 30% (rated voltage) 100 ms, 60% (rated voltage) 1,000 ms, 60% (rated voltage) 5,000 ms, 95% (rated voltage)

# Panasonic

ideas for life

DIN48 SIZE  
ANALOG MULTI-RANGE  
CYCLIC TWIN TIMERS

# PM4H-W

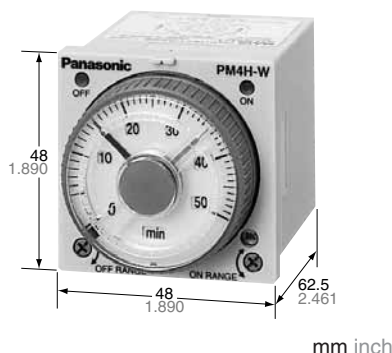

UL File No.: E122222  
CSA File No.: LR39291



## Features

1. A single twin timer unit that repeats (variable) ON/OFF.
2. Multiple ranges with a 0.1 s to 500 h time specification on a single unit.
3. The output ON/OFF operation is indicated by red and green LED's. It's easy to check the operation at a glance.
4. The AC free power supply and shorter body make it easier to use.
5. A new screw terminal type has been added to the conventional pin type. Wiring can be done easily with a screwdriver.
6. Compliant with UL, CSA, CE and LLOYD.

RoHS Directive compatibility information  
<http://www.nais-e.com/>

## Specifications

Item	Type	PM4H-W	
Rating	Rated operating voltage	100 to 240V AC, 48 to 125V DC, 12V DC, 24V AC/DC	
	Rated frequency	50/60Hz common (AC operating type)	
	Rated power consumption	Approx. 10VA (100 to 240V AC) Approx. 2.5VA (24V AC) Approx. 1.5W (12V DC, 24V DC, 48 to 125V DC)	
	Rated control capacity	5A 250V AC (resistive load)	
	Operation mode	Cyclic (OFF-start/Twin operation)	
	Time range	1s to 500h 16 time ranges switchable (T <sub>1</sub> , T <sub>2</sub> time setting individually)	
Time accuracy (Note:)	Operation time fluctuation	±0.3% (power off time change at the range of 0.3s to 1h)	
	Setting error	±5% (Full-scale value)	
	Voltage error	±0.5% (at the operating voltage changes between 85 to 110%)	
	Temperature error	±2% (at 20°C ambient temp. at the range of -10 to +50°C +14 to 122°F)	
Contact	Contact arrangement	Timed-out 2 Form C	
	Contact resistance (Initial value)	Max. 100mΩ (at 1A 6V DC)	
	Contact material	Silver alloy	
Life	Mechanical (contact)	2×10 <sup>7</sup>	
	Electrical (contact)	10 <sup>5</sup> (at rated control capacity)	
Electrical function	Allowable operating voltage range	85 to 110% of rated operating voltage (at 20°C coil temp.)	
	Insulation resistance (Initial value)	Min. 100MΩ Between live and dead metal parts Between input and output Between contacts of different poles (At 500V DC) Between contacts of same pole	
	Breakdown voltage (Initial value)	2,000Vrms for 1 min Between live and metal parts 2,000Vrms for 1 min Between input and output 2,000Vrms for 1 min Between contacts of different poles 1,000Vrms for 1 min Between contacts of same pole	
	Min. power off time	300ms	
	Max. temperature rise	55°C 131°F	
Mechanical function	Vibration resistance	Functional	10 to 55Hz: 1 cycle/min double amplitude of 0.25mm (10min on 3 axes)
		Destructive	10 to 55Hz: 1 cycle/min double amplitude of 0.375mm (1h on 3 axes)
	Shock resistance	Functional	Min. 98m/s <sup>2</sup> (4 times on 3 axes)
		Destructive	Min. 980m/s <sup>2</sup> (5 times on 3 axes)
Operating condition	Ambient temperature	-10 to +50°C +14 to +122°F	
	Ambient humidity	30 to 85%RH (non-condensing)	
	Atmospheric pressure	860 to 1,060hPa	
	Ripple factor (DC type)	20%	
Others	Protective construction	IP65 on front panel (using rubber gasket ATC18002) <only for IP65 type>	
	Weight	120g 4.233 oz (Pin type), 130g 4.586 oz (Screw terminal type)	

Notes: 1) Unless otherwise specified, the measurement conditions at the maximum scale time standard are specified to be the rated operating voltage (within 5% ripple factor for DC), 20°C 68°F ambient temperature, and 1s power off time.

2) For the 1s range, the tolerance for each specification becomes ±10ms.

3) As internal components may become worn when using continuous conduction, the product should be replaced periodically.

# PM4H-W

## Time range

All types of PM4H-W timer have multi-time range.  
16 time ranges are selectable.  
1s to 500h (Max. range) is controlled.

Scale	Time unit	sec	min	hrs	10h
		1	0.1s to 1s	0.1 min to 1 min	0.1h to 1h
5	Control time range	0.5s to 5s	0.5 min to 5 min	0.5h to 5h	5h to 50h
10		1.0s to 10s	1.0 min to 10 min	1.0h to 10h	10h to 100h
50		5s to 50s	5 min to 50 min	5h to 50h	50h to 500h

## Product types

Type	Operating mode	Contact arrangement	Time range	Protective structure	Rated Operating voltage	Terminal type	Part number
PM4H-W Twin timer	Cyclic (OFF-start, Twin)	Relay Timed-out 2 Form C	16 selectable ranges (1s to 500h)	IP65	100 to 240V AC	8 pins	PM4HW-H-AC240VW
						Screw terminal	PM4HW-H-AC240VSW
					48 to 125V DC	8 pins	PM4HW-H-DC125VW
						Screw terminal	PM4HW-H-DC125VSW
					24V AC/DC	8 pins	PM4HW-H-24VW
						Screw terminal	PM4HW-H-24VSW
					12V DC	8 pins	PM4HW-H-DC12VW
						Screw terminal	PM4HW-H-DC12VSW
				IP50	100 to 240V AC	8 pins	PM4HW-H-AC240V
						Screw terminal	PM4HW-H-AC240VS
					48 to 125V DC	8 pins	PM4HW-H-DC125V
						Screw terminal	PM4HW-H-DC125VS
					24V AC/DC	8 pins	PM4HW-H-24V
						Screw terminal	PM4HW-H-24VS
					12V DC	8 pins	PM4HW-H-DC12V
						Screw terminal	PM4HW-H-DC12VS

## Terminal layouts and Wiring diagrams

### Pin Type

Cyclic timed-out relay contact: 2C

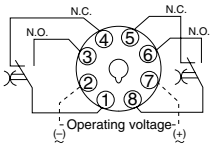

### Screw terminal type

Cyclic timed-out relay contact: 2C

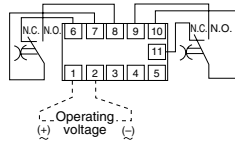

## Dimensions

• Screw terminal type: M3.5

• Pin type

mm inch  
Tolerance:  $\pm 0.5 \pm 0.020$

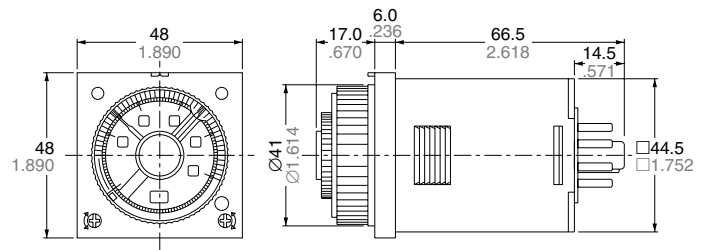
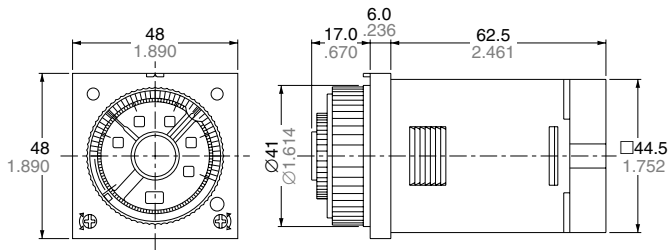

## Operation

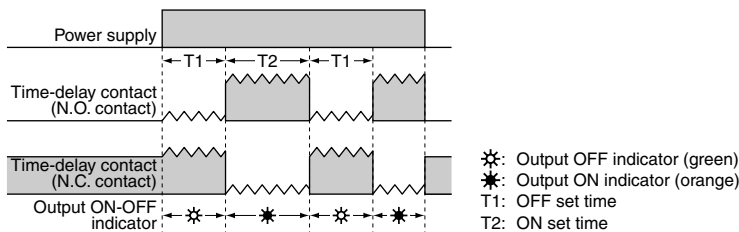

# PM4H SERIES MODES AND TIME SETTING

## 1. Operation method

### 1) Operation mode setting [PM4H-A type]

8 operation modes are selectable with operation mode selector.  
Turn the operation mode selector with screw driver.  
Operation mode is shown up through the window above the mode selector. The marks are (ON), (FL), (FO), (OF), (SF), (OS), (PF), (OC).  
Turn the mode selector to the mark until you can check by clicking sound.  
Confirm the mode selector position if it is correct.  
If the position is not stable, the timer might mis-operate.



### 2) Time range setting [PM4H series common]

16 time ranges are selectable between 1s to 500h.  
Turn the time range selector with the screw driver.  
Clockwise turning increases the time range, and Counter-clockwise turning decrease the time range.  
Confirm the range selector position if it is correct.  
If the position is not stable, the timer might mis-operate.



### 3) Time setting [common]

To set the time, turn the set dial to a desired time within the range.  
Instantaneous output will be on when the dial is set to "0".  
When the instantaneous output is used, the dial should be set under "0" range. (Instantaneous output area)  
When power supply is on, the time range, setting time and operation mode cannot be changed.  
Turn off the power supply or a reset signal is applied to set the new operation mode.  
If the position is not stable, the timer might mis-operate.

## 2. How to use "Set ring" [PM4H series common]

### 1) Fixed time setting

Set the desired time and put 2 set rings together.  
Insert the rings into stopper to fix the time.

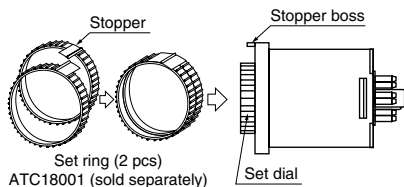

### 2) Time range setting

Example: Time range 20s to 30s.

① Shorter time value setting  
Set the dial to 20s.  
Place the stop ring at the right side of stopper.

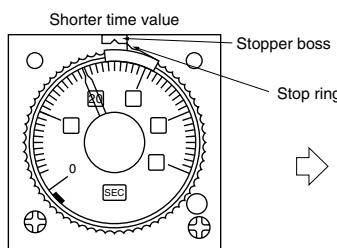

② Longer time value setting  
Set the dial to 30s.  
Place the stop ring at the left side of stopper.

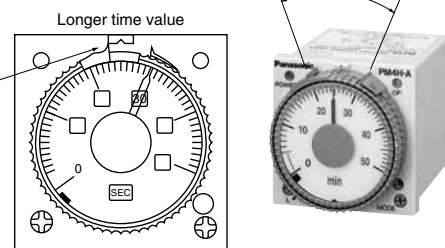

Note) The stoppers for the lower limit setting set ring and the upper limit setting set ring face the opposite directions.

## Applicable standard (PM4H series common)

Safety standard	EN61812-1	Pollution Degree 2/Overvoltage Category III
EMC	(EMI)EN61000-6-4 Radiation interference electric field strength Noise terminal voltage (EMS)EN61000-6-2 Static discharge immunity	EN55011 Group1 ClassA EN55011 Group1 ClassA
	RF electromagnetic field immunity	EN61000-4-2 4 kV contact 8 kV air
	EFT/B immunity	EN61000-4-3 10 V/m AM modulation (80 MHz to 1 GHz) 10 V/m pulse modulation (895 MHz to 905 MHz)
	Surge immunity	EN61000-4-4 2 kV (power supply line) 1 kV (signal line)
	Conductivity noise immunity	EN61000-4-5 1 kV (power line)
	Power frequency magnetic field immunity	EN61000-4-6 10 V/m AM modulation (0.15 MHz to 80 MHz)
	Voltage dip/Instantaneous stop/Voltage fluctuation immunity	EN61000-4-8 30 A/m (50 Hz) EN61000-4-11 10 ms, 30% (rated voltage) 100 ms, 60% (rated voltage) 1,000 ms, 60% (rated voltage) 5,000 ms, 95% (rated voltage)

# PRECAUTIONS IN USING THE PM4H SERIES

## 1. Input connections (PM4H-A type)

1) Be sure not to use terminal ⑩ as the common terminal of the input signal as shown in Fig. A. Otherwise, the internal circuit of the timer may be damaged. Use terminal ② as the common terminal as shown in Fig. B.

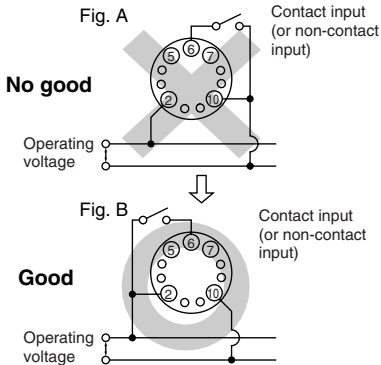

If the circuit is connected as in Fig. C, the internal circuits must be broken. Be sure to connect the circuit as in Fig. D.

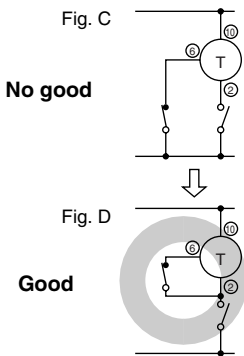

2) When one input signal is simultaneously applied to more than one timer, be sure to avoid the wiring shown in Fig. E. Otherwise, the short-circuit current will flow and cause damage. Be sure to align the polarity of the power supply as shown in Fig. F.

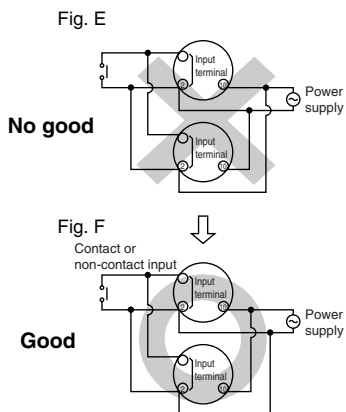

3) Terminal ②-⑥ (screw terminal ②-③) should be connected as the start input. Connect terminals ②-⑦ (screw terminal ②-④) for reset signal input. Connect terminals ②-⑤ (screw terminal ②-⑤) for stop signal input. Be sure not to connect with other terminals and apply excessive voltage. The internal circuit will be damaged.

4) The input wiring other than the power supply circuit should avoid these conditions, high-voltage wiring and parallel wiring with power wire. Wire in short with using the shielding wire or metal wiring tube.

5) For start, reset and stop input, use gold-plated contact with high reliability. Since contact bouncing causes errors in the start, use an input contact less bounce time.

6) Keep the minimum signal input time over 0.05 s.

## 2. Input signal conditions (PM4H-A type)

1) Connection of contact input (Pin type example)

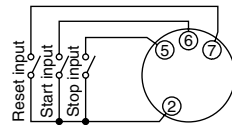

Use gold-plated contacts with high-reliability. The bounce time at the contacts causes errors in the timer operation time. Accordingly, use start input contact whose bounce time is short. The resistance when shorted should be less than  $1k\Omega$ , and when open resistance should be more than  $100k\Omega$ .

For the screw terminal type, connect the terminal ② to the each input signal.

2) Connection of non-contact input (Pin type example) (open-collector)

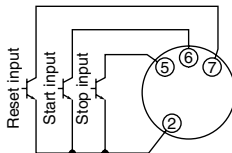

Apply the open-collector connection. The characteristics of the transistor used must be  $V_{CE0}=10V$  or more,  $I_C=10mA$  or more, and  $I_{CBO}=6\mu A$  or less. Additionally, the input impedance must be  $1k\Omega$  or less, and the residual voltage must be  $0.6V$  or less.

For the screw terminal type, connect the terminal ② to the each input signal.

3) Connection of non-contact input (Pin type example) (voltage input)

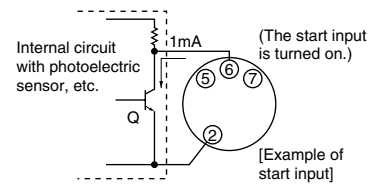

Even if the open collector is not used, input is also possible from the non-contact circuit of 6 to 30V DC. In this case, the start input is turned on when the signal is turned from H to L.

The residual voltage must be  $0.6V$  or less when Q is on. On the AC type, an insulated transformer is required as the power supply for the photoelectric sensor, etc. (power supply for the input devices).

Note: Keep the minimum input signal time of each signal to 0.05s or more.

## 3. Checking the contacts before use (PM4H-F only)

When the power ON time is less than the minimum power application time, the contacts may remain in an ON state, so the state of the contacts should be checked before use. When the contacts are in an ON state, activating them once will return them to their normal state (the OFF state after time-out). (Be aware that relay characteristics may result in the contacts being in that same ON state if exposed to excessive vibration and impact during transport.)

## 4. Time setting

To set the time, turn the set dial to a desired time within the range. Instantaneous output will be on when the dial is set to "0".

When the instantaneous output is used, the dial should be set under "0" range. (Instantaneous output area)

Note) When power supply is on, the time range, setting time and operation mode cannot be changed.

Turn off the power supply or a reset signal is applied to set the new operation mode.

If the position is not stable, the timer might mis-operate.

# PRECAUTIONS IN USING THE PM4H SERIES

## 5. Superimposed surge of power supply (PM4H series common)

For the superimposed surge of power supply, the standard waveform is taken as the standard value for surge-proof voltage.

If external surge occurs exceeding the specified value, the internal circuit may break down. In this case, use a surge absorption element.

Operation voltage	Surge voltage
100 to 240V AC 100 to 120V AC 200 to 240V AC 48 to 125V DC	4,000V
12V DC, 24V DC 24V AC/DC	500V

The positive and negative voltages are applied each five times between the power pins.

The typical surge absorption elements include a varistor, a capacitor, and a diode. If a surge absorption element is used, use an oscilloscope to see whether or not the foreign surge exceeding the specified value appears.

## 6. Acquisition of CE marking

Please abide by the conditions below when using in applications that comply with EN61812-1.

1) Overvoltage category III, pollution level 2

2) This timer employs a power supply without a transformer, so the power and input signal terminals are not insulated.

(PM4H-A only)

(1) When a sensor is connected to the input circuit, install double insulation on the sensor side.

(2) In the case of contact input, use dual-insulated relays, etc.

3) The load connected to the output contact should have basic insulation.

This timer is protected with basic insulation and can be double-insulated to meet EN/IEC requirements by using basic insulation on the load.

4) Please use a power supply that is protected by an overcurrent protection device which complies with the EN/IEC standard (example: 250 V 1 A fuse, etc.).

5) You must use a terminal socket or socket for the installation. Do not touch the terminals or other parts of the timer when it is powered. When installing or un-installing, make sure that no voltage is being applied to any of the terminals.

6) Do not use this timer as a safety circuit. For example when using a timer in a heater circuit, etc., provide a protection circuit on the machine side.