

■ **Low Dropout Linear Regulator**

■ **Features**

- Low dropout voltage
- Load regulation: 0.2% typical
- Optimized for Low Voltage
- On-chip thermal limiting
- 1A Adjustable/Fixed Low Dropout Linear Regulator
- Three-terminal adjustable or fixed low drop out
1.2V, 1.25V, 1.5V, 1.8V, 1.9V, 2.5V, 2.85V, 3.3V, 5V. Regulators

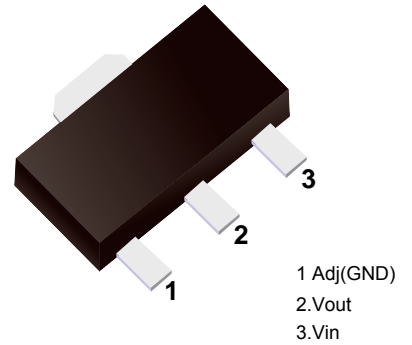

■ **Simplified outline(SOT-89)**

■ **Marking**

Marking	1117-X.X
---------	----------

■ **Absolute Maximum Ratings Ta = 25°C**

Parameter	Symbol	Rating	Unit
Maximum Input Voltage	V _{in}	18	V
Power Dissipation	P _D	Internally Limited	
Operating Junction Temperature Range	T _J	150	°C
Storage Temperature	T _{ST}	-65 to +150	°C

■ **Block Diagram**

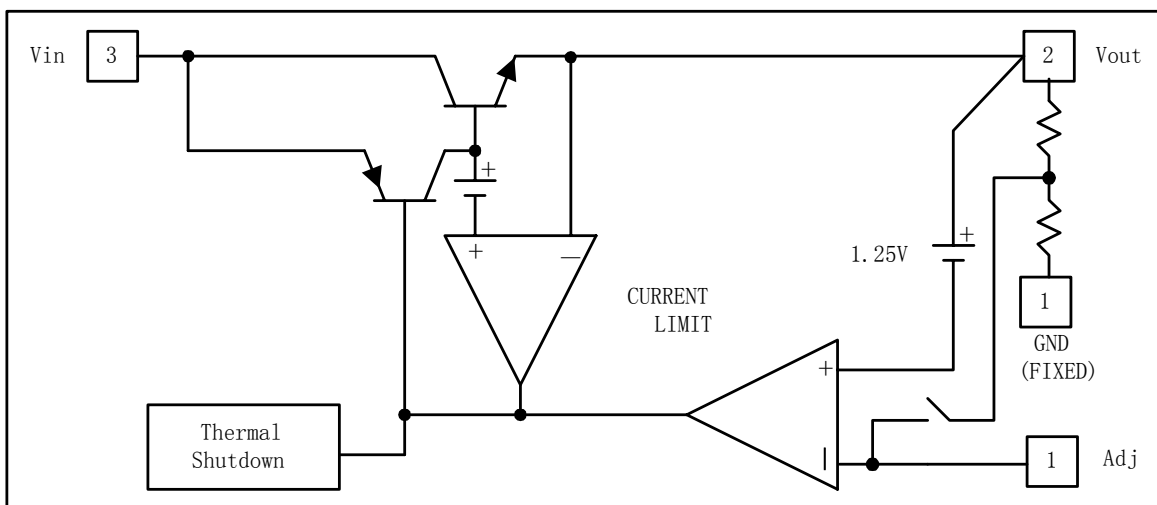

Electrical Characteristics Ta = 25°C

Parameter	Symbol	Test Conditions	Min	Typ	Max	Unit
Reference Voltage	VREF	AMS1117-ADJ 10mA ≤ I _{OUT} ≤ 800mA, 1.5V ≤ V _{IN} - V _{OUT} ≤ 12V	1.225	1.25	1.275	
Output Voltage	V _{OUT}	AMS1117-1.2 0 ≤ I _{OUT} ≤ 800mA, 2.6V ≤ V _{IN} - V _{OUT} ≤ 12V	1.175	1.2	1.225	V
		AMS1117-1.25 0 ≤ I _{OUT} ≤ 800mA, 2.65V ≤ V _{IN} - V _{OUT} ≤ 12V	1.238	1.25	1.275	
		AMS1117-1.5 0 ≤ I _{OUT} ≤ 800mA, 2.9V ≤ V _{IN} - V _{OUT} ≤ 12V	1.47	1.5	1.53	
		AMS1117-1.8 0 ≤ I _{OUT} ≤ 800mA, 3.2V ≤ V _{IN} - V _{OUT} ≤ 12V	1.764	1.8	1.836	
		AMS1117-1.9 0 ≤ I _{OUT} ≤ 800mA, 3.3V ≤ V _{IN} - V _{OUT} ≤ 12V	1.862	1.9	1.938	
		AMS1117-2.5 0 ≤ I _{OUT} ≤ 800mA, 3.9V ≤ V _{IN} - V _{OUT} ≤ 12V	2.45	5.5	2.55	
		AMS1117-2.85 0 ≤ I _{OUT} ≤ 800mA, 4.25V ≤ V _{IN} - V _{OUT} ≤ 12V	2.822	2.85	2.878	
		AMS1117-3.3 0 ≤ I _{OUT} ≤ 800mA, 4.75V ≤ V _{IN} - V _{OUT} ≤ 12V	3.234	3.3	3.366	
		AMS1117-5.0 0 ≤ I _{OUT} ≤ 800mA, 6.5V ≤ V _{IN} - V _{OUT} ≤ 12V	4.9	5	5.1	
Line Regulation	ΔV _{OUT}	AMS1117-ADJ I _{OUT} =10mA, 1.5V ≤ V _{IN} -V _{OUT} ≤ 12V		0.035	0.2	%
		AMS1117-1.2 I _{OUT} =10mA, 2.6V ≤ V _{IN} -V _{OUT} ≤ 12V		9	12	mV
		AMS1117-1.25 I _{OUT} =10mA, 2.65V ≤ V _{IN} -V _{OUT} ≤ 12V				
		AMS1117-1.5 I _{OUT} =10mA, 2.9V ≤ V _{IN} -V _{OUT} ≤ 12V				
		AMS1117-1.8 I _{OUT} =10mA, 3.2V ≤ V _{IN} -V _{OUT} ≤ 12V				
		AMS1117-1.9 I _{OUT} =10mA, 3.3V ≤ V _{IN} -V _{OUT} ≤ 12V				
		AMS1117-2.5 I _{OUT} =10mA, 3.9V ≤ V _{IN} -V _{OUT} ≤ 12V				
		AMS1117-2.85 I _{OUT} =10mA, 4.25V ≤ V _{IN} -V _{OUT} ≤ 12V				
		AMS1117-3.3 I _{OUT} =10mA, 4.75V ≤ V _{IN} -V _{OUT} ≤ 12V				
AMS1117-5.0 I _{OUT} =10mA, 6.5V ≤ V _{IN} -V _{OUT} ≤ 12V						
Load Regulation	ΔV _{OUT}	AMS1117-ADJ V _{IN} -V _{OUT} =3V, 10mA ≤ I _{OUT} ≤ 800mA		0.2	0.4	%
		AMS1117-1.2 V _{IN} =2.6V, 10mA ≤ I _{OUT} ≤ 800mA		3	10	mV
		AMS1117-1.25 V _{IN} =2.65V, 10mA ≤ I _{OUT} ≤ 800mA				
		AMS1117-1.5 V _{IN} =2.9V, 10mA ≤ I _{OUT} ≤ 800mA				
		AMS1117-1.8 V _{IN} =3.2V, 10mA ≤ I _{OUT} ≤ 800mA				
		AMS1117-1.9 V _{IN} =3.3V, 10mA ≤ I _{OUT} ≤ 800mA				
		AMS1117-2.5 V _{IN} =3.9V, 10mA ≤ I _{OUT} ≤ 800mA				
		AMS1117-2.85 V _{IN} =4.25V, 10mA ≤ I _{OUT} ≤ 800mA				
		AMS1117-3.3 V _{IN} =4.75V, 10mA ≤ I _{OUT} ≤ 800mA				
AMS1117-5.0 V _{IN} =6.5V, 10mA ≤ I _{OUT} ≤ 800mA						
Dropout Voltage	V _{IN} -V _{OUT}	AMS1117-XXX ΔV _{OUT} , ΔV _{REF} =1%, I _{OUT} =0.1A		1.11	1.2	V
		AMS1117-XXX ΔV _{OUT} , ΔV _{REF} =1%, I _{OUT} =0.5A		1.18	1.25	
		AMS1117-XXX ΔV _{OUT} , ΔV _{REF} =1%, I _{OUT} =0.8A		1.26	1.3	
Current Limit	I _{limit}	AMS1117-XXX V _{IN} -V _{OUT} =5V, T _J = 25°C	1.25	1.4	1.6	A
		AMS1117-XXX AMS1117-ADJ		5	10	mA
Adjust Pin Current	I _{ADJ}			55	120	uA
Adjust Pin Current Change	I _{Change}			0.2		

Electrical Characteristics Ta = 25°C

Quiescent Current	I _Q	AMS1117-1.2	V _{IN} -V _{OUT} =1.25V		4	8	mA
		AMS1117-1.25					
		AMS1117-1.5					
		AMS1117-1.8					
		AMS1117-1.9					
		AMS1117-2.5					
		AMS1117-2.85					
		AMS1117-3.3					
		AMS1117-5.0					

■ Typical Applications

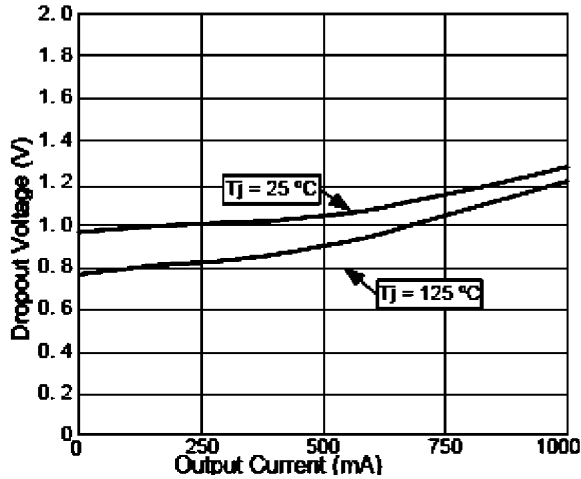

Fig.1 Dropout Voltage vs Output Current

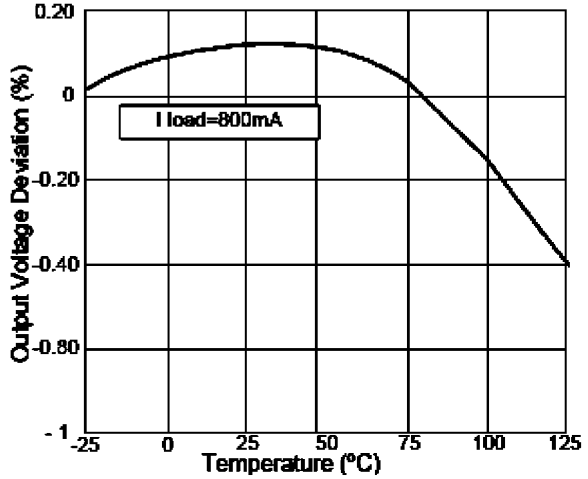

Fig.2 Load Regulation vs Temperature

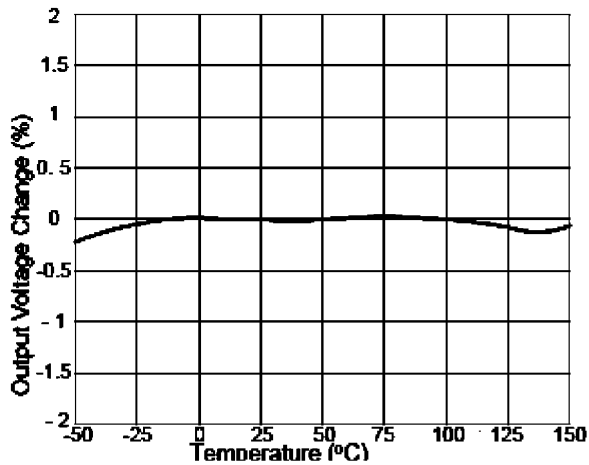

Fig.3 Percent Change in Output Voltage vs Temperature

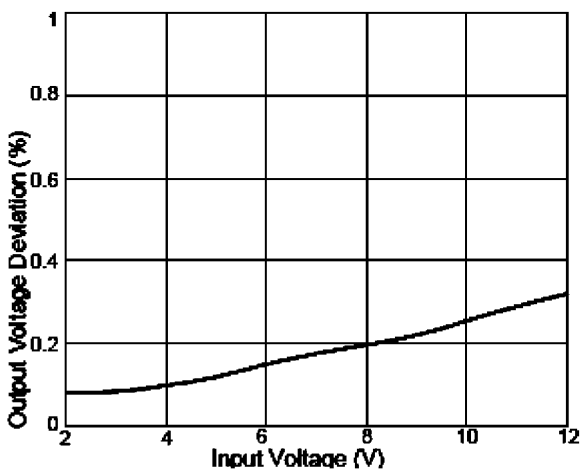

Fig.4 Line Regulation

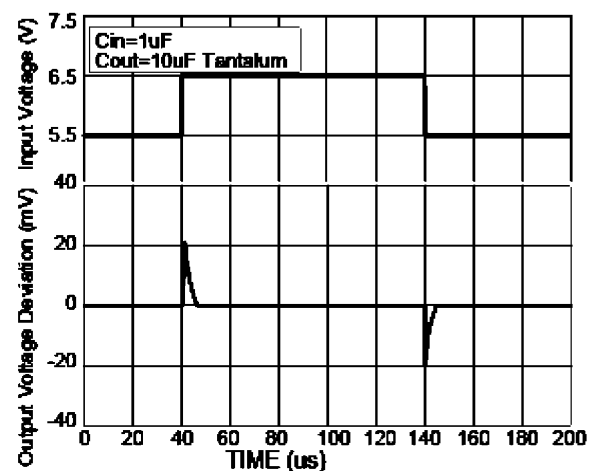

Fig.5 Line Transient Response

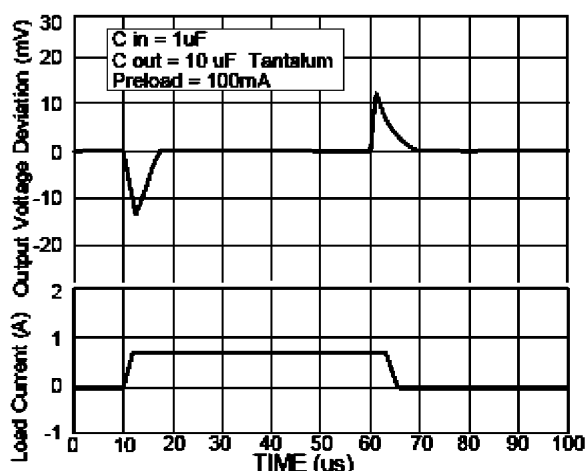
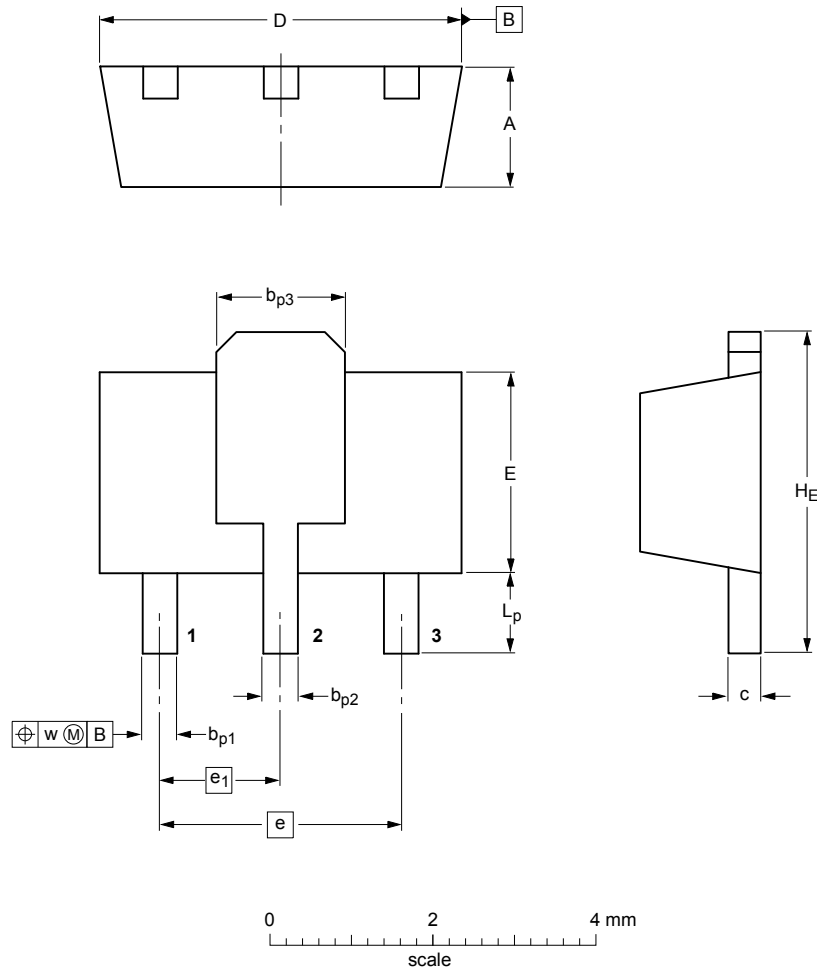

Fig.6 Load Transient Response

Package Outline

SOT-89



DIMENSIONS (mm are the original dimensions)

UNIT	A	b _{p1}	b _{p2}	b _{p3}	c	D	E	e	e ₁	H _E	L _p	w
mm	1.6 1.4	0.48 0.35	0.53 0.40	1.8 1.4	0.44 0.23	4.6 4.4	2.6 2.4	3.0	1.5	4.25 3.75	1.2 0.8	0.13

Summary of Packing Options

Package	Package Description	Packing Quantity	Industry Standard
SOT-89	Tape/Reel, 7" reel	1000	EIA-481-1