

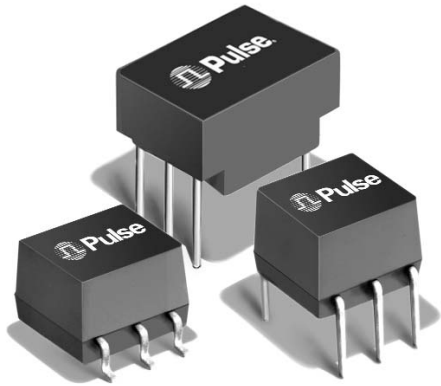





T3/DS3/E3/STS-1 TRANSFORMERS

Designed for T3, DS3, E3 and
STS-1 Interfaces



-  Return loss meets requirements of G.703
-  Fast rise time compatible with standards
-  Through hole and surface mount packages available
-  UL recognized
-  RoHS-5 compliant

Electrical Specifications @ 25°C — Operating Temperature 0°C to 70°C

Part Number	Turns Ratio (±2%)	OCL Primary (μH MIN)	OCL at -40°C (μH MIN)	LL (μH MAX)	C _{w/w} (pF MAX)	Bandwidth 75Ω System (MHz TYP)	Isolation Voltage (V _{rms} MIN)	Package/Schematic	Primary Pins
PE-65661	1:2CT	35	20	.12	10	–	1500	TR-2/B SMT	2-6
PE-65662	1:1	45	30	.12	13	–	1500	TR-2/A SMT	2-6
PE-65663	1:1	40	30	.12	13	–	1500	QC-1/A THT	2-6
PE-65664	1:2CT	35	20	.12	10	–	1500	QC-1/B THT	2-6
PE-65779	1:4CT	150	–	.30	15	–	1500	QC-1/B THT	2-6
PE-65856	1:1.73CT	50	–	.10	12	.060-300	1500	LC-1/C THT	4-6
PE-65966	1:1	40	–	.10	10	.200-340	1500	LC-1/E THT	4-6
PE-65967	1:1	40	–	.10	10	.200-340	1500	LS-1/E SMT	4-6
PE-65968	1:2CT	19	–	.06	10	.250-500	1500	LS-1/C SMT	4-6
PE-65969	1:2CT	19	–	.06	10	.250-500	1500	LC-1/C THT	4-6
PE-68629	1:1	40	–	.10	5	–	3000 ⁴	HC-1/A THT	1-5
PE-68630	1:2CT	19	–	.06	10	–	3000 ⁴	HC-1/D THT	1-5

Electrical Specifications @ 25°C

Part Number	Turns Ratio (Pri:Sec ±5%)	OCL @ 25°C (mH MIN)	C _{w/w} (pF MAX)	L _L (μH MAX)	DCR Pri (Ω MAX)	DCR Sec (Ω MAX)	Isolation Voltage (V _{rms} MIN)	Package/Schematic	Primary Pins
PE-64934	1:1	1.20	25	0.50	0.70	0.70	1500	HC-1/1S	1-2

Packaging Information

Package	Type	Part Weight	Parts/Tube	Parts/Reel	Reel Diameter	Tape Width	Pitch
LS-1	SMT	0.6 grams	70	600	13 inches	24 mm	16 mm
TR-2	SMT	0.6 grams	65	500	13 inches	24 mm	16 mm
LC-1	THT	0.6 grams	65	–	–	–	–
HC-1	THT	1.2 grams	60	–	–	–	–
QC-1	THT	0.8 grams	60	–	–	–	–

T3/DS3/E3/STS-1 TRANSFORMERS

Designed for T3, DS3, E3 and
STS-1 Interfaces



Mechanical

Schematics

TR-2

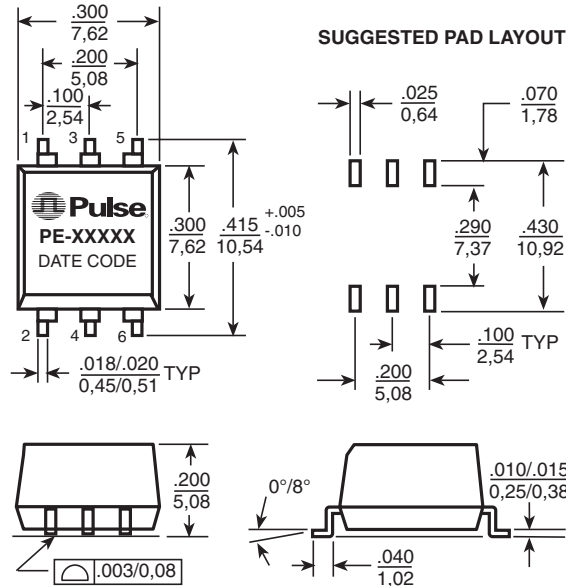

Dimensions: $\frac{\text{Inches}}{\text{mm}}$

Unless otherwise specified all tolerances are $\pm \frac{.010}{0,25}$

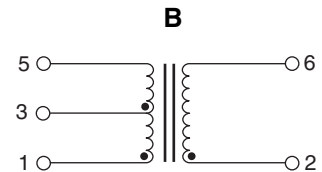
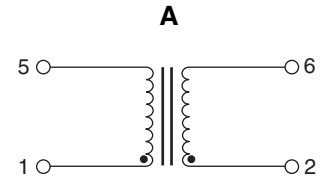

QC-1

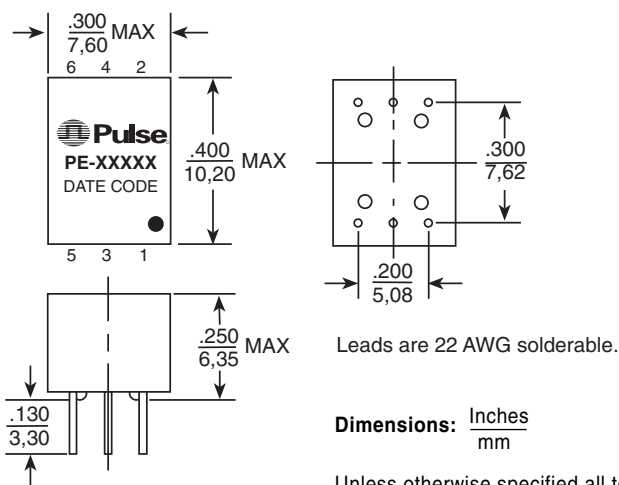

Leads are 22 AWG solderable.

Dimensions: $\frac{\text{Inches}}{\text{mm}}$

Unless otherwise specified all tolerances are $\pm \frac{.010}{0,25}$

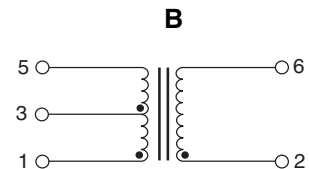
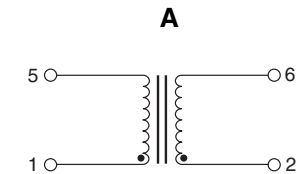

T3/DS3/E3/STS-1 TRANSFORMERS

Designed for T3, DS3, E3 and
STS-1 Interfaces



Mechanical

Schematics

LC-1

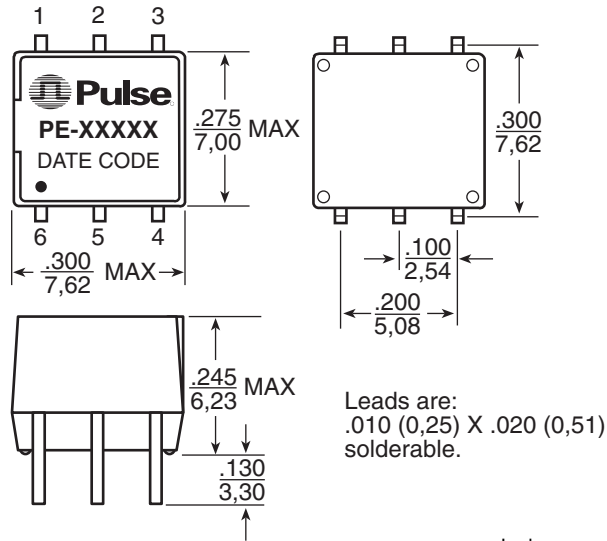

Dimensions: Inches
mm

Unless otherwise specified all tolerances are $\pm \frac{.010}{0,25}$

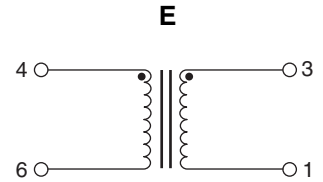
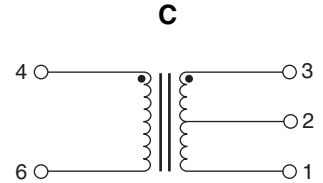

HC-1

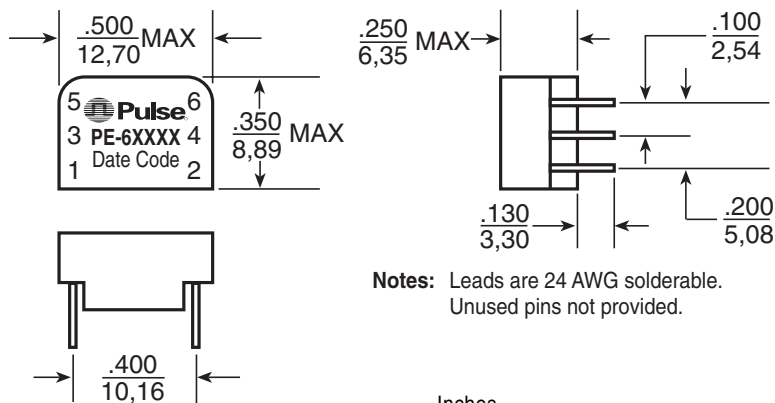

Dimensions: Inches
mm

Unless otherwise specified all tolerances are $\pm \frac{.010}{0,25}$

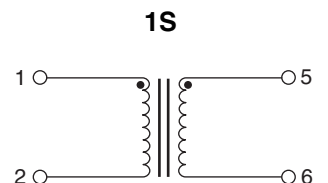
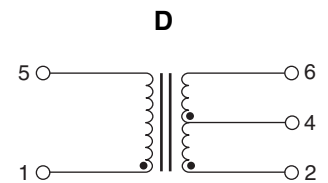
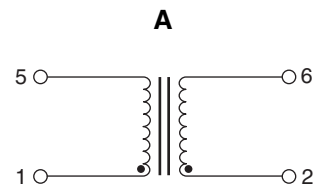

T3/DS3/E3/STS-1 TRANSFORMERS

Designed for T3, DS3, E3 and STS-1 Interfaces



Mechanical

Schematics

LS-1

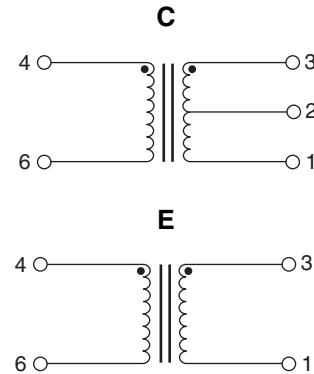
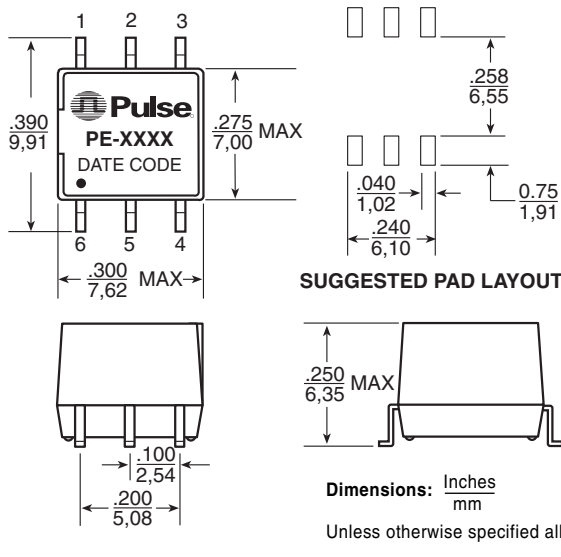

Transformer Selection Guide

Chip Manufacturer	Surface Mount		Through Hole (1500 Vrms)		Through Hole (3000 Vrms)	
	Transmit	Receive	Transmit	Receive	Transmit	Receive
Lucent						
T7296	PE-65967	-	PE-65966	-	PE-68629	-
Exar						
XR-T7296	PE-65967	-	PE-65966	-	PE-68629	-
Silicon Systems						
SSI 78P236, DS3	PE-65968	PE-65967	PE-65969	PE-65966	PE-68630	PE-68629
SSI 78P7200, DS3	PE-65968	PE-65967	PE-65969	PE-65966	PE-68630	PE-68629
SSI 78P7200, E3	PE-65968	PE-65968	PE-65969	PE-65969	PE-68630	PE-68630
SSI 78P2361, STS-1	PE-65968	PE-65967	PE-65969	PE-65966	PE-68630	PE-68629
SSI 78P2362, E3	PE-65968	PE-65967	PE-65969	PE-65966	PE-68630	PE-68629
Transwitch						
MRT TXC-02050 ⁵ , E3	PE-65968	PE-65967	PE-65969	PE-65966	PE-68630	PE-68629
ART 02020 DS3, STS-1	PE-65967	PE-65967	PE-65966	PE-65966	PE-68629	PE-68629

Application Notes

- The transformers have been developed for use as transmit and receive transformers in T3 or DS3 links, using bit rates of 44.736 Mbps and B3ZS coding on coaxial cable. The characteristics allow compliance with the pulse templates of CCITT G.703 as well as ATT T.A.34. The transformers are also suitable for the E3 interface at 34.368 Mbps with HDB3 coding or STS-1 applications, at 51.84 Mbps according to Bellcore TANWT-000253. The LC-1 and QC-1 packages are pin compatible with T1-1 and T4-1 6-pin DIP packages.
- Bandwidth specifications are typical in a 75 Ω system. Return loss meets the requirements of G.703. Materials used in the products are UL94-V0 recognized. Products meet the requirements of IEC 695-2-2 (Needle Flame Test).
- The surface mount LS-1 and TR-2 packages are available with optional tape and reel packaging. To order, add a "T" suffix to the part number (i.e.: PE-65967T).
- The Transwitch MRT TXC-02050 chip is also designed to operate in 6.312 and 8.448 Mbps interfaces. A 1:1 transformer (PE-64934) is recommended.
- All transformers listed on this data sheet are RoHS-5 compliant. For RoHS-6 compliant versions of these parts, please contact Pulse.

For More Information:

Pulse Worldwide Headquarters
12220 World Trade Drive
San Diego, CA 92128
U.S.A.
www.pulseeng.com
TEL: 858 674 8100
FAX: 858 674 8262

Pulse Northern Europe
3 Huxley Road
Surrey Research Park
Guildford, Surrey GU2 5RE
United Kingdom
TEL: 44 1483 401700
FAX: 44 1483 401701

Pulse Southern Europe
Zone Industrielle
F-39270
Orgelet
France
TEL: 33 3 84 35 04 04
FAX: 33 3 84 25 46 41

Pulse China Headquarters
No. 1
Industrial District
Changan, Dongguan
China
TEL: 86 769 5538070
FAX: 86 769 5538870

Pulse North China
Room 1002
No. 819
Nanjing West Rd
Shanghai
China
TEL: 86 21 32181071
FAX: 86 21 32181396

Pulse South Asia
150 Kampong Ampat
#07-01/02
KA Centre
Singapore 368324
TEL: 65 6287 8998
FAX: 65 6280 0080

Pulse North Asia
3F-4, No. 81, Sec. 1
Hsin Tai Wu Road
Hsi-Chih
Taipei Hsien
Taiwan
TEL: 886 2 26980228
FAX: 886 2 26980948

Performance warranty of products offered on this data sheet is limited to the parameters specified. Data is subject to change without notice. Other brand and product names mentioned herein may be trademarks or registered trademarks of their respective owners.

© Copyright, 2006. Pulse Engineering, Inc. All rights reserved.