

Series PVX6012PbF

Microelectronic Power IC Relay
IGBT Photovoltaic Relay
Single Pole, Normally Open,
0-280V_{AC} (RMS) or 0-400V_{DC}, 1.0A AC/DC

General Description

The PVX6012 Photovoltaic Relay is a single-pole, normally open solid-state relay that can replace electromechanical relays in many applications. It utilizes an IGBT output switch, driven by an integrated circuit photovoltaic generator of novel construction. The output switch is controlled by radiation from a GaAlAs light emitting diode (LED) which is optically isolated from the photovoltaic generator.

The PVX6012 is ideally suited for switching medium power loads. It offers high operating speed, low and stable on-state voltage drop as well as low off-state leakage current.

PVX6012 relays are packaged in a 14-pin, molded DIP package in thru-hole. It is available in standard plastic shipping tubes.

Applications

- Test Equipment
- Industrial Controls and Automation
- Electromechanical Relay Replacement
- Mercury-wetted Relay Replacement

Features

- IGBT and HEXFRED™ output
- Bounce-free operation
- 3,750 VRMS I/O isolation
- High load current capacity
- Low off-state leakage current
- Solid-State Reliability
- UL Recognized

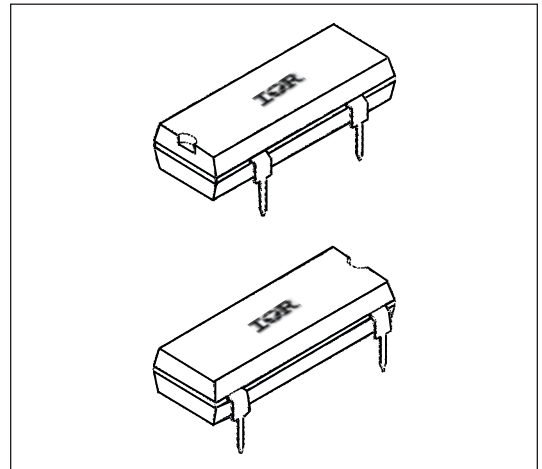

Part Identification

PVX6012PbF thru-hole

(HEXFET is the registered trademark for International Rectifier Power MOSFETs)

Electrical Specifications ($-40^{\circ}\text{C} \leq T_A \leq +85^{\circ}\text{C}$ unless otherwise specified)

INPUT CHARACTERISTICS	Limits	Units
Minimum Control Current (see figure 1)	5.0	mA
Maximum Control Current for Off-State Leakage @ $T_A=+25^{\circ}\text{C}$	0.4	mA
Control Current Range (Caution: current limit input LED, see figure 6)	5.0 to 25	mA
Maximum Reverse Voltage	6.0	V

OUTPUT CHARACTERISTICS	Limits	Units
Transient Overvoltage Protection	600	V (DC or AC peak)
Operating Voltage	0-280 0-400	V(AC) RMS V (DC)
Maximum Load Current @ $T_A=+40^{\circ}\text{C}$ 5mA Control (see figures 1 and Note 1)	1.0 1.0	A(DC) A(AC) RMS
Maximum Surge Current @ $T_A=+40^{\circ}\text{C}$ non-repetitive, 1 sec. non-repetitive, 20 msec. (see figure 2)	5 20	A(DC) A(DC)
Maximum On-State Voltage Drop @ $T_A=+25^{\circ}\text{C}$ For 1A pulsed load, 5mA Control (see figures 3 and 4)	2.5	V
Maximum Off-State Leakage @ $T_A=+25^{\circ}\text{C}$, $\pm 400\text{V}$ (see figures 5)	10	μA
Maximum Turn-On Time @ $T_A=+25^{\circ}\text{C}$ (see figures 8) For 1A, 400 Vdc load, 5mA Control	7	ms
Maximum Turn-ff Time @ $T_A=+25^{\circ}\text{C}$ (see figures 8) For 1A, 400 Vdc load, 5mA Control	1	ms
Maximum Output Capacitance @ 100VDC (see figures 7)	50	pF

GENERAL CHARACTERISTICS	Limits	Units	
Minimum Dielectric Strength, Input-Output	3750	V _{RMS}	
Minimum Insulation Resistance, Input-Output @ $T_A=+25^{\circ}\text{C}$, 50%RH, 100 VDC	10^{12}	Ω	
Maximum Capacitance, Input-Output	1.0	pF	
Maximum Pin Soldering Temperature (10 seconds maximum)	+260	°C	
Ambient Temperature Range:	Operating		-40 to +85
	Storage		-40 to +100

International Rectifier does not recommend the use of this product in aerospace, avionics, military or life support applications. Users of this International Rectifier product in such applications assume all risks of such use and indemnify International Rectifier against all damages resulting from such use.

Connection Diagram
 Output AC or DC Load

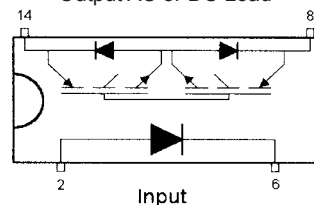

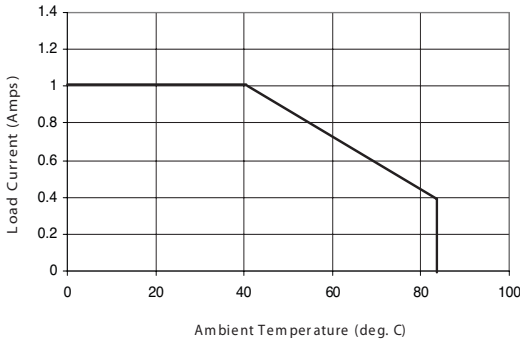

Figure 1. Current Derating Curves

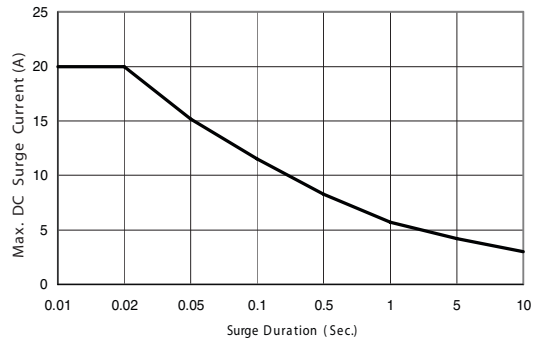

Figure 2. Surge Current Capability

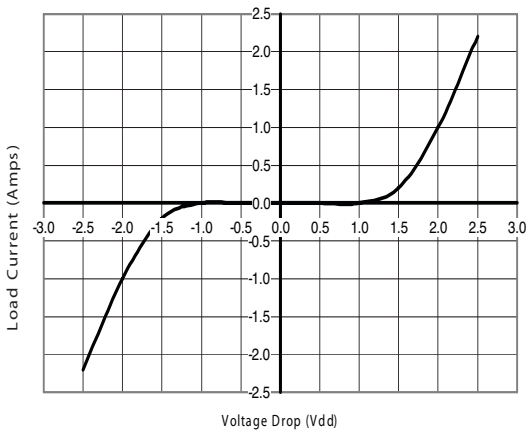

Figure 3. Output Characteristics

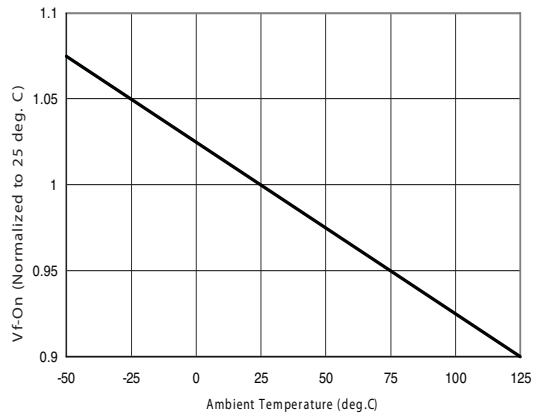

Figure 4. Typical Normalized V_{CEON}

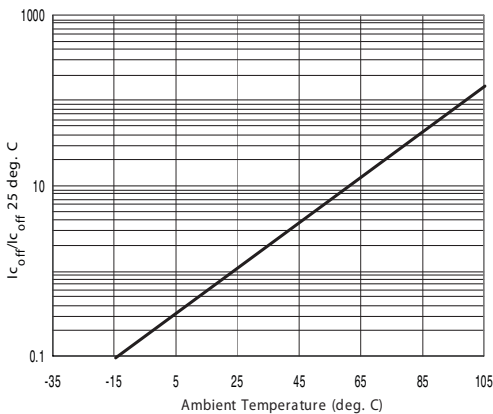

Figure 5. Typical Normalized Off-State Leakage

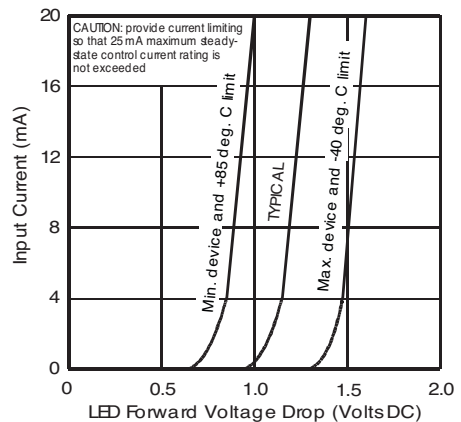

Figure 6. Input Characteristics (Current Controlled)

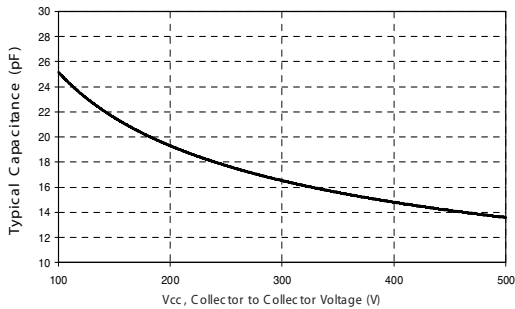

Figure 7. Typical Output Capacitance

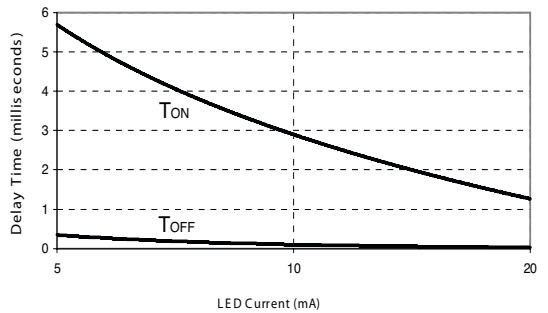

Figure 8. Typical Delay Time

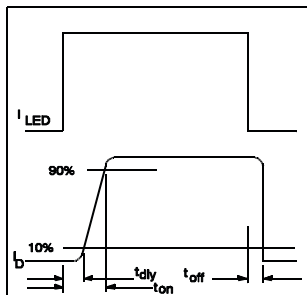

Figure 9. Delay Time Definitions

Case Outlines

NOTES:

1. DIMENSIONING & TOLERANCING PER ANSI Y14.5M-1982.
2. CONTROLLING DIMENSION: INCH.
3. DIMENSIONS ARE SHOWN IN MILLIMETERS [INCHES].
4. OUTLINE CONFORMS TO JEDEC OUTLINE MS-001AA.
- 5 MEASURED WITH THE LEADS CONSTRAINED TO BE PERPENDICULAR TO DATUM PLANE C.
- 6 DIMENSION DOES NOT INCLUDE MOLD PROTUSIONS. MOLD PROTUSIONS SHALL NOT EXCEED 0.25 [0.010].

01-3062 00