

Environment Resistant Type Optical / Electrical Combined Connectors

FSE Series

DDK Ltd.

OUTLINE

● FSE connector is mobile phone base stations, computer information proven connection is waterproof connector outdoor surveillance cameras.



FEATURE

◆ Locking-with-one-touch system

It has erroneous-engagement prevention mechanism including five positioning keys at the engagement section. Insert the connector, turn the coupling clockwise until a click sounds, which means that secure engagement has been attained.

◆ Waterproof (oil-resistant) and dust-resistant design (IP67)

Receptacle has an O ring, so once it is mated with a plug, the mating section prevents perfectly invasion of water drops, cutting oil and dusts.

The cable-connection side of plug has a cable clamp with rubber bushing meeting the requirement for waterproofness.

◆ Combined optical and electric arrangement.

Combined optical and electrical connection combination of max eight conductors the is available.

SPECIFICATIONS



Environmental performance	Operating Temperature	-25°C to +70°C		
	Relative Moisture	When not Connected	80% max.	
		When Connected	100%	
	Waterproof Rating	When Connected	IP67	
Mechanical performance	Mating Cycle	500 times		
Optical performance	Insertion Loss	Fiber	SM 10/125	GI 50/125
		PC Polish	0.7dB max.	0.5dB max.
Electric performance	Applicable Wire Size	AWG16 Max.		
	Dielectric Withstanding Voltage	1500V DC		
	Insulation Resistance	1,000 M Ω min. (500V DC)		
	Contact Resistance	10 m Ω max.		

© Specifications and/or dimensions in this catalogue are subject to change without notice.

Your catalogue checking the latest specifications with our drawings would be highly appreciated.

▶ Plug Connector

FSE-14P-220-12F-D

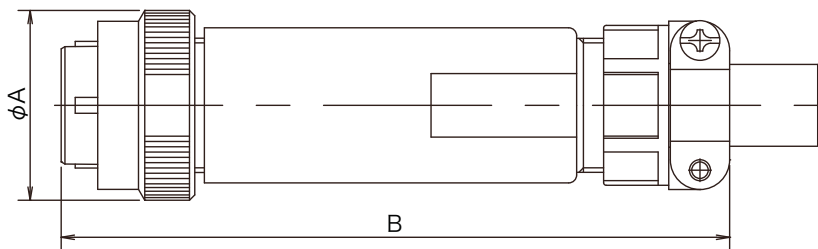
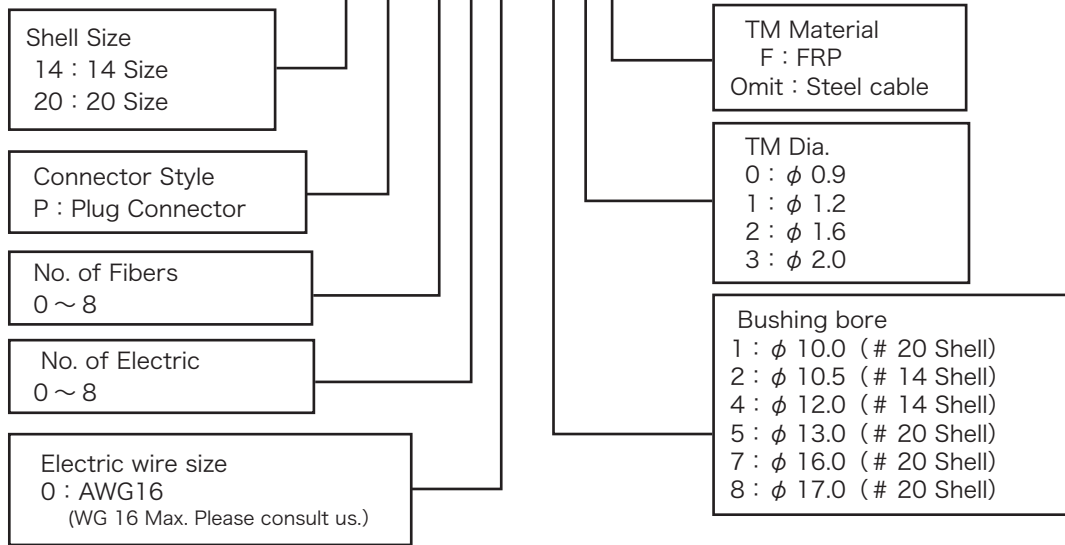

Shell Size	Part Number	Optical / Electric	Bushing	TM Dia.	TM Material	ϕA	B
14	FSE-14P-40-2 □□ -D	4/0	ϕ 10.5	ϕ 0.9	Steel wire FRP	35.9	(100)
	FSE-14P-20-2 □□ -D	2/0		ϕ 1.2			
	FSE-14P-220-2 □□ -D	2/2		ϕ 1.6			
	FSE-14P-40-4 □□ -D	4/0	ϕ 12.0	ϕ 0.9	Steel wire FRP		
	FSE-14P-20-4 □□ -D	2/0		ϕ 1.2			
	FSE-14P-220-4 □□ -D	2/2		ϕ 1.6			
20	FSE-20P-80-1 □□ -D	8/0	ϕ 10.0	ϕ 0.9	Steel wire FRP	40.6	(110)
	FSE-20P-230-1 □□ -D	2/3		ϕ 1.2			
	FSE-20P-440-1 □□ -D	4/4		ϕ 1.6			
	FSE-20P-80-5 □□ -D	8/0	ϕ 13.0	ϕ 0.9	Steel wire FRP		
	FSE-20P-230-5 □□ -D	2/3		ϕ 1.2			
	FSE-20P-440-5 □□ -D	4/4		ϕ 1.6			
	FSE-20P-80-7 □□ -D	8/0	ϕ 16.0	ϕ 0.9	Steel wire FRP		
	FSE-20P-230-7 □□ -D	2/3		ϕ 1.2			
FSE-20P-440-7 □□ -D	4/4	ϕ 1.6					

© Specifications and/or dimensions in this catalogue are subject to change without notice.

Your catalogue checking the latest specifications with our drawings would be highly appreciated.

▶ Receptacle

FSE-14R-220-221-D

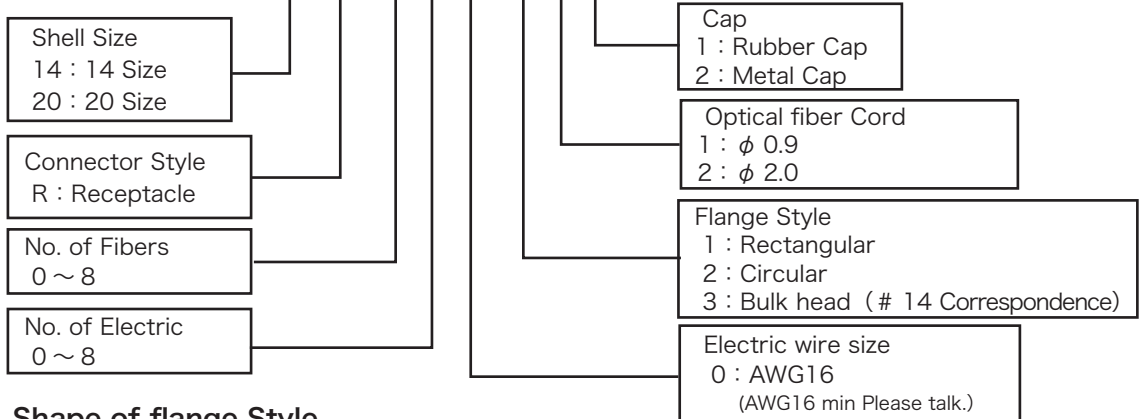

Shape of flange Style

Circular

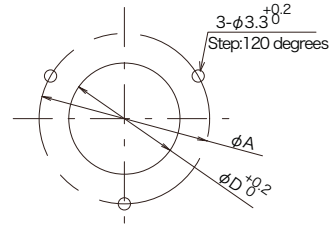
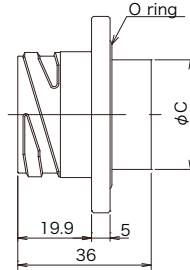
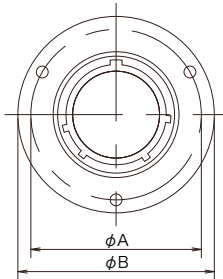

Mounting Dimensions

Rectangular

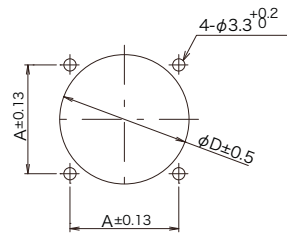
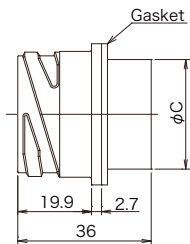
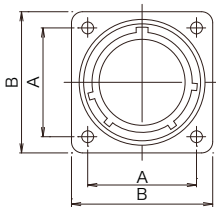

Mounting Dimensions

Bulk Head

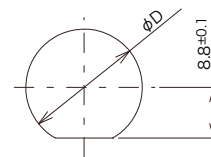
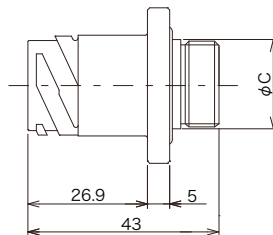
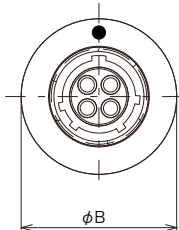

Mounting Dimensions
Panel Thickness: 1.5mm min

Shell Size	Part Number	Optical / Electric	Flange Style	Cord Dia.	Cap	A	B	C	D
14	FSE-14R-40-2 □□ -D	4/0	Circular Style	φ 0.9	Rubber Cap	32.0	38.0	18.5	19.0
	FSE-14R-20-2 □□ -D	2/0		φ 2.0	Metal Cap				
	FSE-14R-220-2 □□ -D	2/2							
	FSE-14R-40-3 □□ -D	4/0	Bulk Head	φ 0.9	Rubber Cap	—	35.0	20.0	20.0
	FSE-14R-20-3 □□ -D	2/0		φ 2.0	Metal Cap				
	FSE-14R-220-3 □□ -D	2/2							
20	FSE-20R-80-1 □□ -D	8/0	Rectangular Style	φ 0.9	Rubber Cap	29.36	38.1	29.6	16.0
	FSE-20R-230-1 □□ -D	2/3		φ 2.0	Metal Cap				
	FSE-20R-440-1 □□ -D	4/4							

© Specifications and/or dimensions in this catalogue are subject to change without notice.
Your catalogue checking the latest specifications with our drawings would be highly appreciated.