



3 V, SUPER MINIMOLD 900 MHz Si MMIC AMPLIFIER

UPC2747TB UPC2748TB

FEATURES

- **HIGH DENSITY SURFACE MOUNTING:**
6 pin super minimold or SOT-363 package
- **GAIN:**
UPC2747TB: $G_s = 12$ dB TYP
UPC2748TB: $G_s = 19$ dB TYP
- **NOISE FIGURE:**
UPC2747TB: NF = 3.3 dB TYP
UPC2748TB: NF = 2.8 dB TYP
- **SUPPLY VOLTAGE:**
 $V_{CC} = 2.7$ to 3.3 V

DESCRIPTION

NEC's UPC2747TB and UPC2748TB are Silicon RFIC's which are manufactured using the NESAT III process. These devices are suitable as buffer amplifiers for cellular radio and other communication receivers. The UPC2747TB/48TB are pin compatible and have comparable performance as the larger UPC2747T/48T, so they are suitable for use as a replacement to help reduce system size. The IC's are housed in a 6 pin super minimold or SOT-363 package. NEC's stringent quality assurance and test procedures ensure the highest reliability and performance.

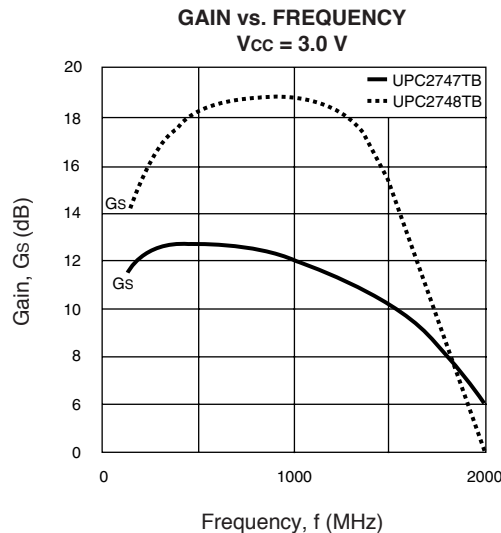

ELECTRICAL CHARACTERISTICS ($T_A = 25^\circ\text{C}$, $Z_L = Z_S = 50 \Omega$)

PART NUMBER PACKAGE OUTLINE			UPC2747TB SO6			UPC2748TB SO6		
SYMBOLS	PARAMETERS AND CONDITIONS	UNITS	MIN	TYP	MAX	MIN	TYP	MAX
I_{CC}	Circuit Current (no signal) $V_{CC} = 3.0$ V $V_{CC} = 1.8$ V	mA mA	3.8	5.0 3.0	7.0	4.5	6.0 3.5	8.0
G_s	Small Signal Gain, $f = 900$ MHz, $V_{CC} = 3.0$ V $f = 900$ MHz, $V_{CC} = 1.8$ V	dB dB	9	12 5.5	14	16	19 11.5	21
f_{L1}	Lower Limit Operating Frequency, $V_{CC} = 3.0$ V $V_{CC} = 1.8$ V	GHz GHz					0.2 0.2	0.4
f_{U2}	Upper Limit Operating Frequency, $V_{CC} = 3.0$ V $V_{CC} = 1.8$ V	GHz GHz	1.5	1.8 1.8		1.2	1.5 1.5	
P_{SAT}	Saturated Output Power, $f = 900$ MHz, $V_{CC} = 3.0$ V $f = 900$ MHz, $V_{CC} = 1.8$ V	dBm dBm	-9.5	-7 -14		-6	-3.5 -10	
NF	Noise Figure, $f = 900$ MHz, $V_{CC} = 3.0$ V $f = 900$ MHz, $V_{CC} = 1.8$ V	dB dB		3.3 5.2	4.5		2.8 4.5	4.0
RLIN	Input Return Loss, $f = 900$ MHz, $V_{CC} = 3.0$ V $f = 900$ MHz, $V_{CC} = 1.8$ V	dB dB	11	14 11		8.5	11.5 10	
RLOUT	Output Return Loss, $f = 900$ MHz, $V_{CC} = 3.0$ V $f = 900$ MHz, $V_{CC} = 1.8$ V	dB dB	7	10 13		5.5	8.5 12	
ISOL	Isolation, $f = 900$ MHz, $V_{CC} = 3.0$ V $f = 900$ MHz, $V_{CC} = 1.8$ V	dB dB	35	40 34		35	40 34	
OIP3	SSB Output Third Order Intercept, $P_{OUT} = -20$ dBm $f_1 = 900$ MHz, $f_2 = 902$ MHz, $V_{CC} = 3.0$ V $f_1 = 900$ MHz, $f_2 = 902$ MHz, $V_{CC} = 1.8$ V	dBm dBm		-3 -10			-1 -6	
RTH (J-A)	Thermal Resistance (Junction to Ambient) Mounted on a 50 x 50 x 1.6 mm epoxy glass PWB	$^\circ\text{C}/\text{W}$			325			325

Note:

1. The gain at f_L is 3 dB down from the gain at 900 MHz.
2. The gain at f_U is 3 dB down from the gain at 900 MHz.

UPC2747TB, UPC2748TB

ABSOLUTE MAXIMUM RATINGS¹ (T_A = 25°C)

SYMBOLS	PARAMETERS	UNITS	RATINGS
V _{CC}	Supply Voltage	V	4.0
I _{CC}	Total Supply Current	mA	15
P _{IN}	Input Power	dBm	0
P _T	Total Power Dissipation ²	mW	200
T _{OP}	Operating Temperature	°C	-40 to +85
T _{STG}	Storage Temperature	°C	-55 to +150

Notes:

1. Operation in excess of any one of these parameters may result in permanent damage.
2. Mounted on a 50 x 50 x 1.6 mm epoxy glass PWB (T_A = 85°C).

RECOMMENDED OPERATING CONDITIONS

SYMBOLS	PARAMETERS	UNITS	MIN	TYP	MAX
V _{CC}	Supply Voltage	V	2.7	3	3.3
T _{OP}	Operating Temperature	°C	-40	25	85

TEST CIRCUIT

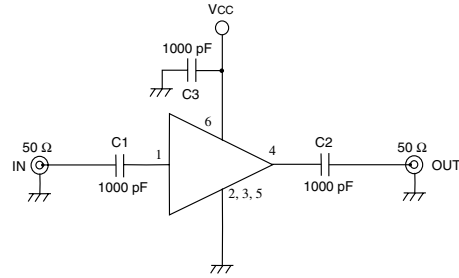

TYPICAL PERFORMANCE CURVES (T_A = 25°C)

CURRENT vs. SUPPLY VOLTAGE

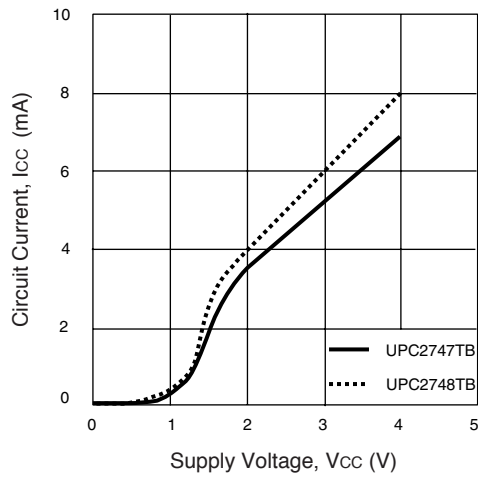

CURRENT vs. OPERATING TEMPERATURE

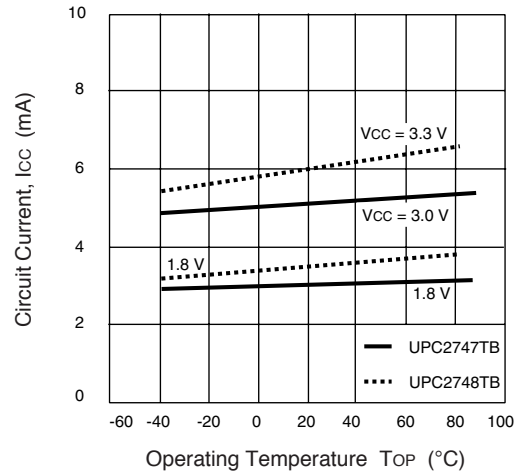

UPC2747TB GAIN vs. FREQUENCY AND TEMPERATURE

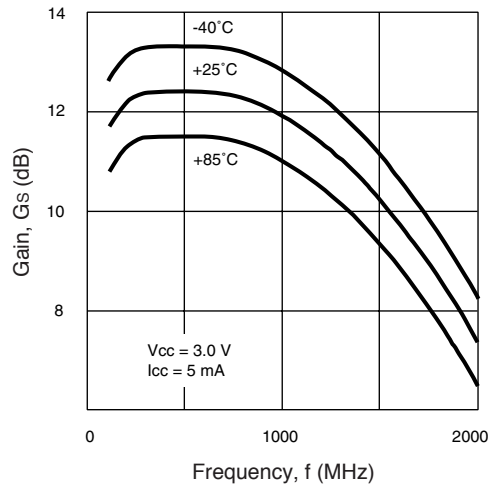

UPC2747TB GAIN AND NOISE FIGURE vs. FREQUENCY

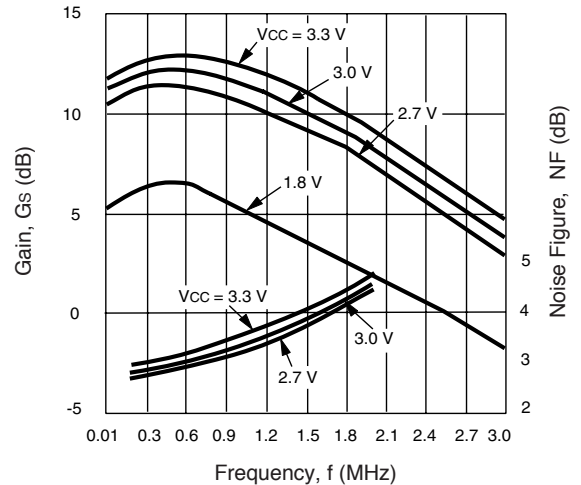

TYPICAL PERFORMANCE CURVES (TA = 25°C)

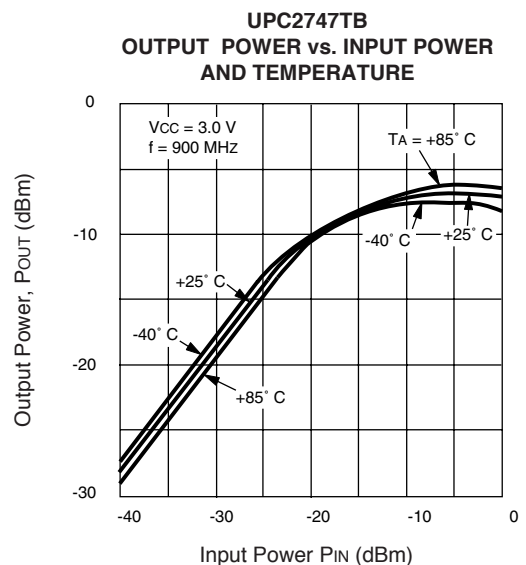
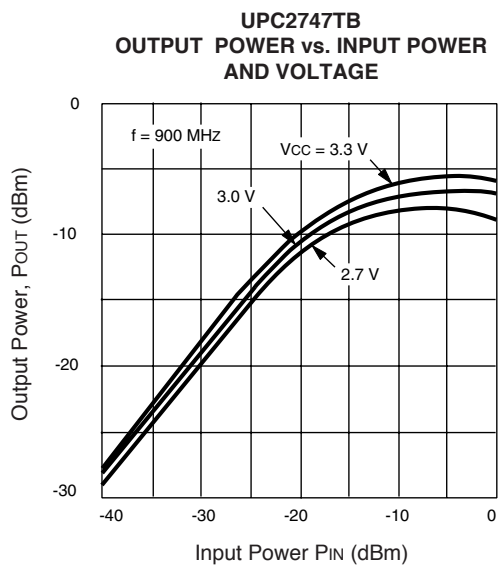
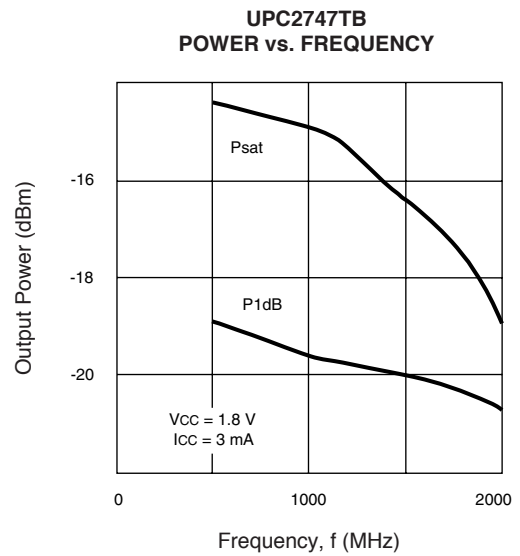
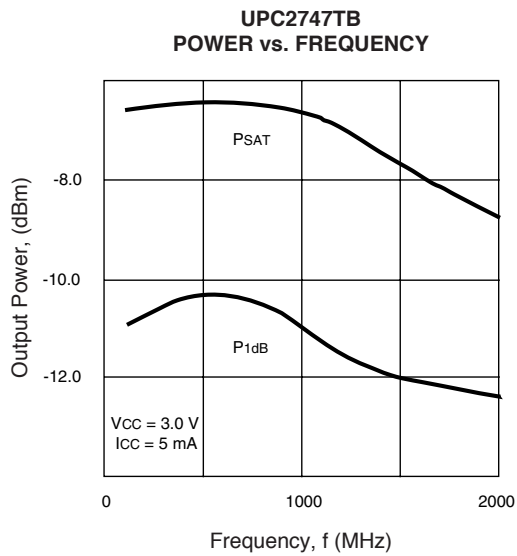
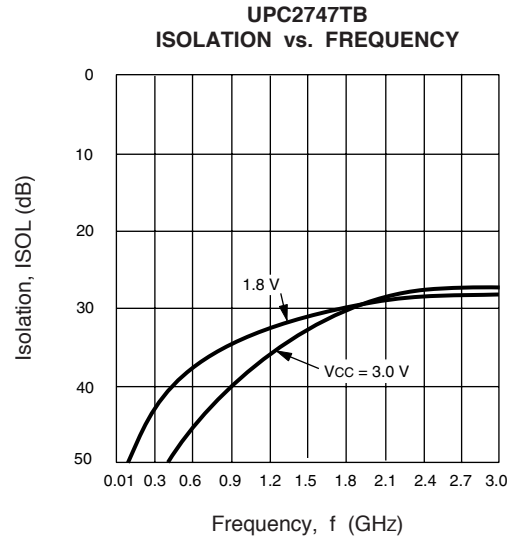
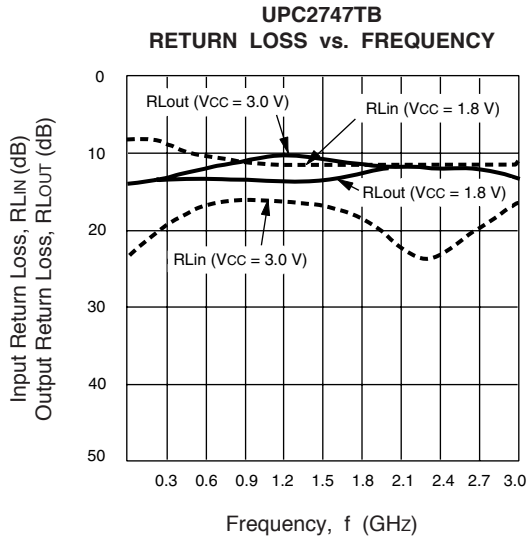

TYPICAL PERFORMANCE CURVES (TA = 25°C)

UPC2748TB
GAIN vs. FREQUENCY
AND TEMPERATURE

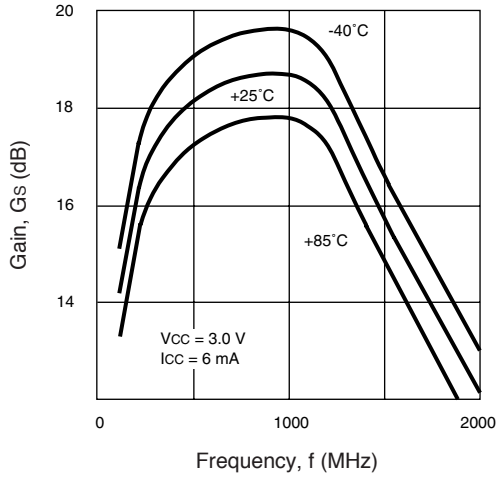

UPC2748TB
GAIN and NOISE FIGURE
vs. FREQUENCY

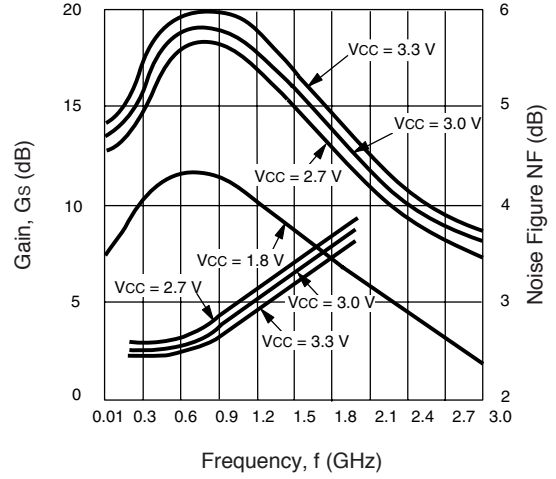

UPC2748TB
ISOLATION vs. FREQUENCY

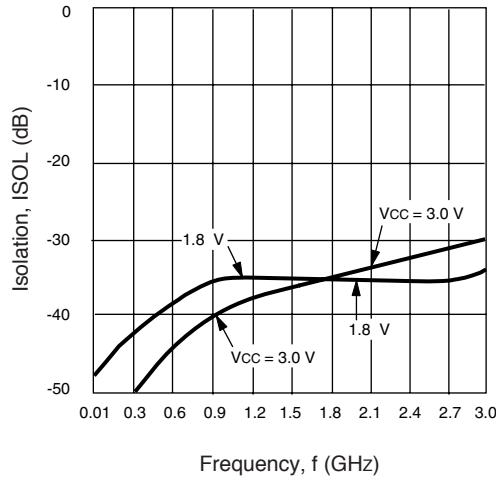

UPC2748TB
RETURN LOSS vs. FREQUENCY

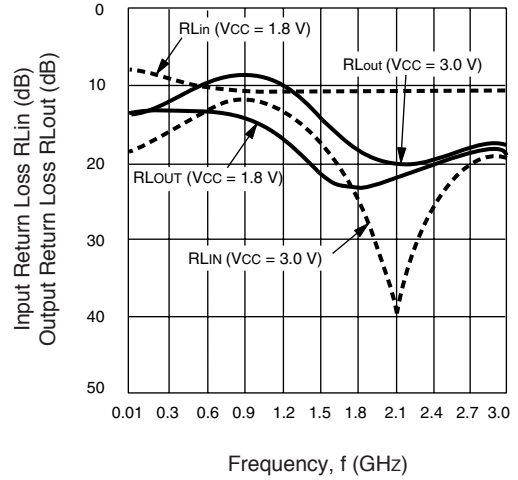

UPC2748TB
POWER vs. FREQUENCY

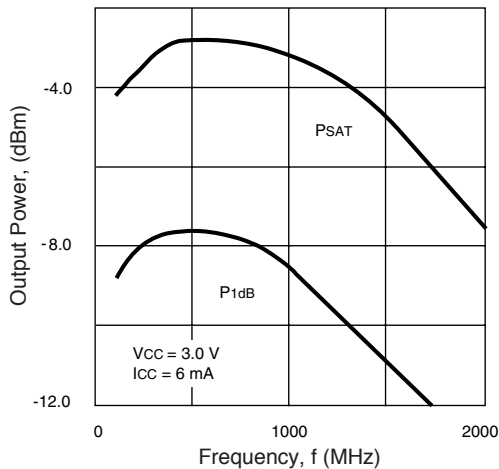

UPC2748TB
POWER vs. FREQUENCY

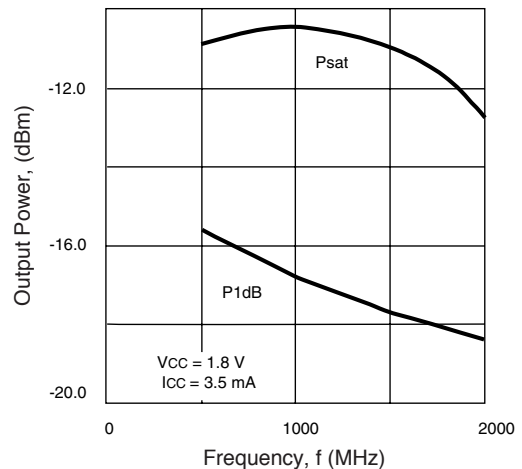

TYPICAL PERFORMANCE CURVES ($T_A = 25^\circ\text{C}$)

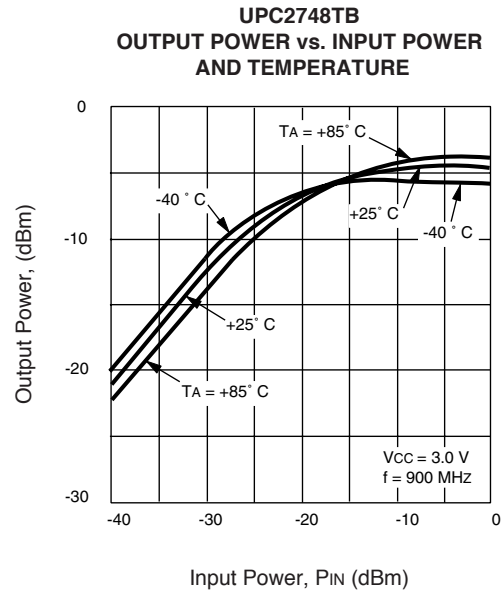
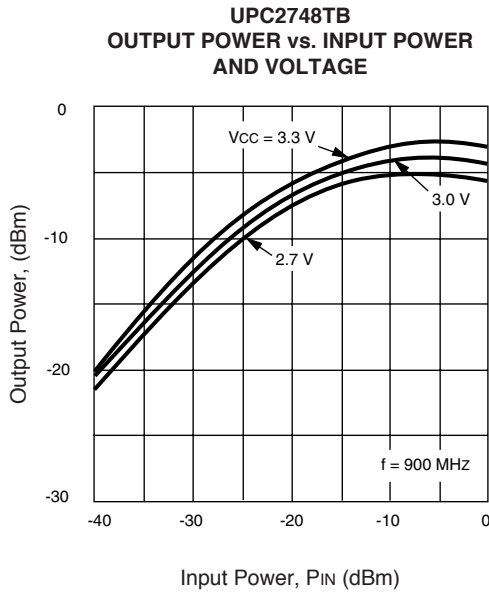

PIN DESCRIPTION

Pin No.	Pin Name	Applied Voltage (V)	Description	Internal Equivalent Circuit
1	Input	0.8 ¹ 0.8 ²	Signal input pin. An internal matching circuit, configured with resistors, enables 50 Ω connection over a wide bandwidth. A multi-feedback circuit is designed to cancel the deviations of h_{FE} and resistance. This pin must be coupled to the signal source with a blocking capacitor.	
4	Output	2.79 ¹ 2.72 ²	Signal output pin. An internal matching circuit, configured with resistors, enables 50 Ω connection over a wide bandwidth. This pin must be coupled to the output load with a blocking capacitor.	
6	VCC	2.7 to 3.3	Power supply pin. This pin should be externally equipped with a bypass capacitor to minimize ground impedance.	
2 3 5	GND	0	Ground pin. This pin should be connected to system ground with minimum inductance. Ground pattern on the board should be formed as wide as possible. All the ground pins must be connected together with wide ground pattern to minimize impedance difference.	

The above diagram is for the UPC2747TB. The resistor marked with a star does not exist in the UPC 2748TB.

- Notes:
 1. UPC2747TB.
 2. UPC2748TB.

TYPICAL SCATTERING PARAMETERS (TA = 25°C)

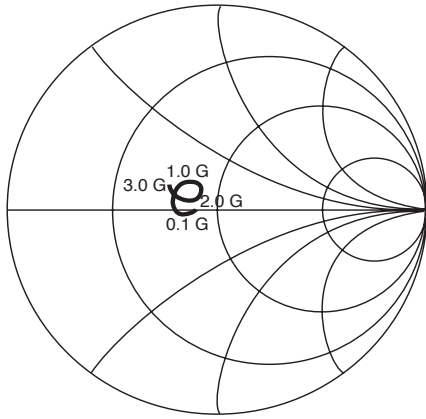

S11

UPC2747TB
Coordinates in Ohms
Frequency in GHz
Vcc = Vout = 3.0 V

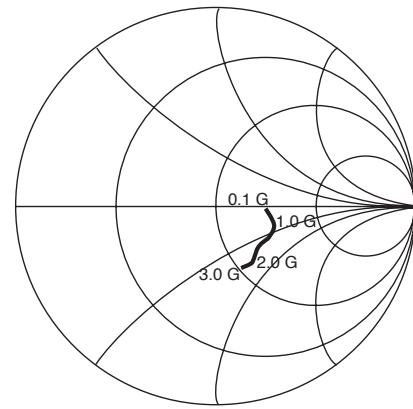

S22

Vcc = Vout = 3.0 V, Icc = 5.0 mA

FREQUENCY GHz	S11		S21		S12		S22		K
	MAG	ANG	MAG	ANG	MAG	ANG	MAG	ANG	
0.1	0.091	-178.3	3.732	-3.9	0.001	28.0	0.290	-3.7	98.96
0.2	0.105	-161.2	3.997	-13.3	0.002	103.2	0.294	-4.3	64.71
0.3	0.136	-166.8	4.075	-23.4	0.002	76.0	0.292	-3.9	46.80
0.4	0.165	-172.9	4.105	-32.9	0.004	90.4	0.286	-5.6	29.99
0.5	0.179	177.8	4.141	-41.2	0.004	89.4	0.298	-6.9	25.94
0.6	0.185	170.1	4.098	-49.5	0.005	90.7	0.302	-8.4	20.69
0.7	0.189	162.5	4.124	-57.9	0.006	96.6	0.307	-10.2	17.38
0.8	0.189	155.1	4.104	-66.3	0.008	101.3	0.309	-12.2	12.59
0.9	0.182	148.8	4.061	-74.5	0.009	99.2	0.313	-14.4	12.26
1.0	0.180	142.6	4.016	-83.0	0.012	99.9	0.316	-16.9	9.45
1.1	0.174	137.1	3.977	-91.8	0.013	100.3	0.318	-19.7	8.22
1.2	0.160	131.5	3.948	-99.5	0.015	105.5	0.318	-22.6	7.49
1.3	0.148	127.4	3.799	-108.4	0.016	96.6	0.318	-24.9	7.42
1.4	0.134	124.4	3.736	-115.9	0.019	93.8	0.313	-27.4	6.36
1.5	0.124	121.0	3.582	-124.0	0.022	93.8	0.311	-30.1	5.83
1.6	0.110	121.0	3.506	-131.7	0.023	88.1	0.312	-31.8	5.55
1.7	0.099	122.9	3.317	-138.8	0.025	88.6	0.308	-33.3	5.37
1.8	0.089	126.8	3.190	-145.7	0.028	88.3	0.305	-35.1	5.05
1.9	0.084	134.8	3.040	-152.8	0.030	80.2	0.305	-37.2	4.98
2.0	0.085	141.7	2.901	-159.0	0.032	78.7	0.303	-38.8	4.97
2.1	0.087	148.1	2.736	-164.8	0.034	77.6	0.299	-40.9	4.99
2.2	0.092	152.1	2.645	-170.8	0.035	73.0	0.304	-41.5	4.97
2.3	0.102	156.6	2.507	-176.3	0.037	72.5	0.304	-42.2	4.93
2.4	0.114	158.7	2.395	-177.8	0.038	68.5	0.305	-44.7	5.01
2.5	0.126	161.4	2.312	172.9	0.041	66.2	0.317	-45.8	4.76
2.6	0.136	160.6	2.218	168.1	0.042	64.0	0.319	-47.8	4.78
2.7	0.154	161.3	2.136	162.1	0.042	60.4	0.323	-50.8	4.88
2.8	0.168	160.4	2.036	157.8	0.044	54.8	0.331	-54.1	4.88
2.9	0.180	157.9	1.952	151.6	0.044	53.0	0.330	-57.5	5.07
3.0	0.196	155.2	1.847	147.6	0.043	47.2	0.332	-60.9	5.45
3.1	0.208	152.5	1.757	141.6	0.045	44.0	0.331	-65.5	5.49

TYPICAL SCATTERING PARAMETERS (TA = 25°C)

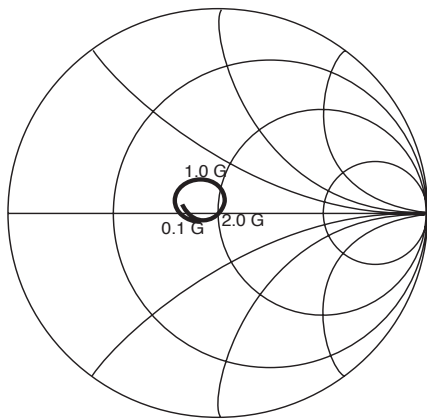

S11

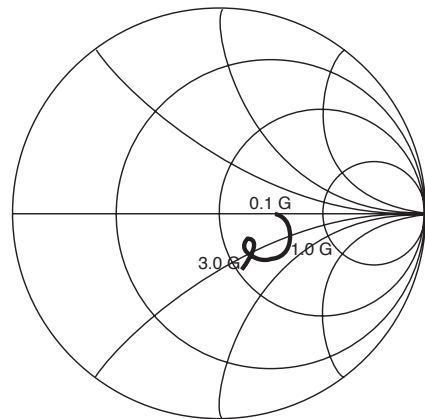

S22

UPC2748TB
 Coordinates in Ohms
 Frequency in GHz
 Vcc = Vout = 3.0 V

Vcc = Vout = 3.0 V, Icc = 6.0 mA

FREQUENCY GHz	S11		S21		S12		S22		K
	MAG	ANG	MAG	ANG	MAG	ANG	MAG	ANG	
0.1	0.120	-177.2	4.730	5.3	0.000	-30.4	0.280	-2.2	352.73
0.2	0.136	-167.3	5.430	-0.2	0.001	19.3	0.285	-2.4	72.83
0.3	0.166	-174.2	5.930	-9.2	0.001	97.8	0.286	-0.9	52.47
0.4	0.194	179.6	6.314	-18.8	0.003	125.4	0.291	-2.7	24.77
0.5	0.210	169.6	6.701	-28.2	0.004	108.7	0.306	-3.7	16.82
0.6	0.213	160.0	6.876	-38.8	0.005	107.4	0.319	-5.4	12.40
0.7	0.213	150.2	7.203	-49.3	0.006	98.7	0.337	-8.4	10.09
0.8	0.211	140.8	7.310	-60.6	0.009	114.1	0.349	-12.3	6.68
0.9	0.203	131.1	7.354	-71.5	0.010	107.6	0.360	-17.4	5.68
1.0	0.193	121.1	7.371	-81.9	0.012	98.3	0.371	-22.7	4.71
1.1	0.180	110.8	7.346	-92.8	0.014	99.1	0.366	-28.9	3.98
1.2	0.159	100.6	7.334	-102.4	0.015	97.5	0.359	-35.3	4.01
1.3	0.136	90.6	7.001	-112.6	0.016	91.4	0.342	-40.7	3.95
1.4	0.115	79.2	6.834	-121.3	0.018	84.1	0.320	-46.0	3.71
1.5	0.096	70.4	6.437	-130.1	0.019	84.8	0.296	-50.5	3.77
1.6	0.072	60.9	6.181	-138.2	0.020	82.4	0.271	-53.0	3.81
1.7	0.049	47.5	5.710	-145.4	0.020	78.9	0.247	-55.1	4.13
1.8	0.024	36.5	5.372	-152.5	0.021	73.5	0.228	-55.7	4.22
1.9	0.007	-6.0	5.014	-158.6	0.021	74.1	0.208	-55.7	4.57
2.0	0.014	-126.0	4.724	-164.1	0.024	74.9	0.198	-52.8	4.37
2.1	0.034	-141.3	4.405	-169.7	0.024	71.5	0.188	-52.1	4.70
2.2	0.047	-147.7	4.175	-174.7	0.026	73.6	0.190	-47.8	4.44
2.3	0.063	-156.9	3.933	-179.5	0.026	71.2	0.185	-45.3	4.81
2.4	0.079	-161.1	3.738	175.3	0.028	69.1	0.192	-44.7	4.58
2.5	0.094	-165.5	3.579	171.2	0.030	63.8	0.202	-43.2	4.48
2.6	0.108	-169.0	3.411	166.5	0.030	64.7	0.214	-43.6	4.59
2.7	0.123	-174.7	3.283	161.4	0.032	64.6	0.222	-45.7	4.54
2.8	0.139	-178.9	3.107	157.3	0.031	58.9	0.238	-47.6	4.83
2.9	0.151	175.9	2.989	151.4	0.032	53.2	0.240	-52.4	4.84
3.0	0.164	170.5	2.814	147.3	0.033	51.6	0.251	-55.8	4.99
3.1	0.178	166.0	2.680	141.5	0.034	47.3	0.254	-61.4	5-07

OUTLINE DIMENSIONS (Units in mm)

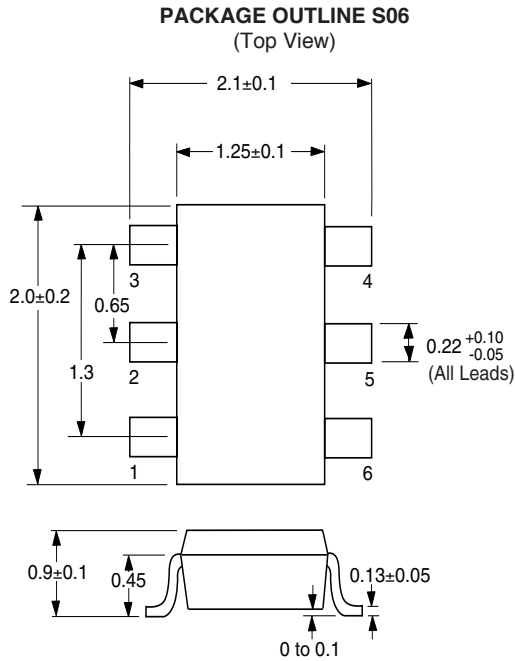

PIN CONNECTIONS

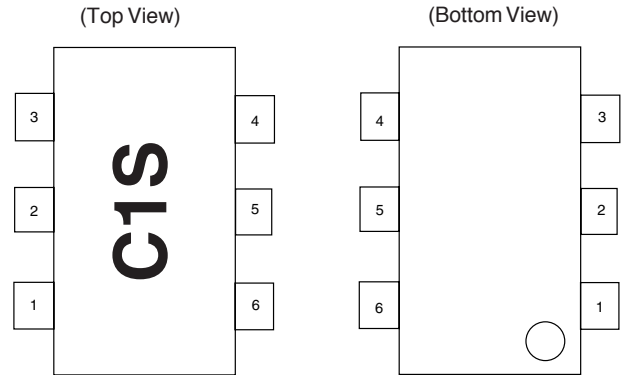

*Marking is an example of UPC2747TB

- 1. INPUT
- 2. GND
- 3. GND
- 4. OUTPUT
- 5. GND
- 6. VCC

SYSTEM APPLICATION EXAMPLE

DIGITAL CELLULAR SYSTEM BLOCK DIAGRAM

Example of 900 MHz Band Digital Cellular Phone

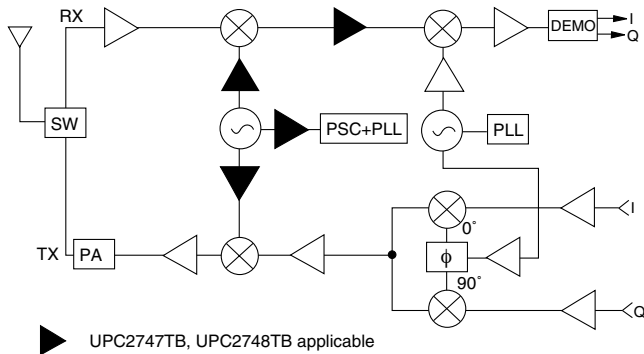

ORDERING INFORMATION

PART NUMBER	MARKING	QTY
UPC2747TB-E3-A	C1S	3K/Reel
UPC2748TB-E3-A	C1T	3K/Reel

Note:

Embossed Tape, 8 mm wide. Pins 1, 2 and 3 face perforated side of tape.

Life Support Applications

These NEC products are not intended for use in life support devices, appliances, or systems where the malfunction of these products can reasonably be expected to result in personal injury. The customers of CEL using or selling these products for use in such applications do so at their own risk and agree to fully indemnify CEL for all damages resulting from such improper use or sale.

EXCLUSIVE NORTH AMERICAN AGENT FOR **NEC** RF, MICROWAVE & OPTOELECTRONIC SEMICONDUCTORS
CEL CALIFORNIA EASTERN LABORATORIES • Headquarters • 4590 Patrick Henry Drive • Santa Clara, CA 95054-1817 • (408) 988-3500 • Telex 34-6393 • FAX (408) 988-0279
 24-Hour Fax-On-Demand: 800-390-3232 (U.S. and Canada only) • Internet: <http://WWW.CEL.COM>

DATA SUBJECT TO CHANGE WITHOUT NOTICE

05/11/2000

Subject: Compliance with EU Directives

CEL certifies, to its knowledge, that semiconductor and laser products detailed below are compliant with the requirements of European Union (EU) Directive 2002/95/EC Restriction on Use of Hazardous Substances in electrical and electronic equipment (RoHS) and the requirements of EU Directive 2003/11/EC Restriction on Penta and Octa BDE.

CEL Pb-free products have the same base part number with a suffix added. The suffix –A indicates that the device is Pb-free. The –AZ suffix is used to designate devices containing Pb which are exempted from the requirement of RoHS directive (*). In all cases the devices have Pb-free terminals. All devices with these suffixes meet the requirements of the RoHS directive.

This status is based on CEL’s understanding of the EU Directives and knowledge of the materials that go into its products as of the date of disclosure of this information.

Restricted Substance per RoHS	Concentration Limit per RoHS (values are not yet fixed)	Concentration contained in CEL devices	
		-A	-AZ
Lead (Pb)	< 1000 PPM	Not Detected	(*)
Mercury	< 1000 PPM	Not Detected	
Cadmium	< 100 PPM	Not Detected	
Hexavalent Chromium	< 1000 PPM	Not Detected	
PBB	< 1000 PPM	Not Detected	
PBDE	< 1000 PPM	Not Detected	

If you should have any additional questions regarding our devices and compliance to environmental standards, please do not hesitate to contact your local representative.

Important Information and Disclaimer: Information provided by CEL on its website or in other communications concerning the substance content of its products represents knowledge and belief as of the date that it is provided. CEL bases its knowledge and belief on information provided by third parties and makes no representation or warranty as to the accuracy of such information. Efforts are underway to better integrate information from third parties. CEL has taken and continues to take reasonable steps to provide representative and accurate information but may not have conducted destructive testing or chemical analysis on incoming materials and chemicals. CEL and CEL suppliers consider certain information to be proprietary, and thus CAS numbers and other limited information may not be available for release.

In no event shall CEL’s liability arising out of such information exceed the total purchase price of the CEL part(s) at issue sold by CEL to customer on an annual basis.

See CEL Terms and Conditions for additional clarification of warranties and liability.