

SG - 203

The SG - 203 photointerrupter high - performance standard type, combines high - output GaAs IRED with high sensitive phototransistor.

**FEATURES**

- 0.5mm aperture
- High - speed reponse
- Available for 2 type P.C.Bs.
- Widely applicable

**APPLICATIONS**

- Copiers
- Facsimiles
- Printers
- Edge sensors
- Floppy disk drives

**DIMENSIONS**

(Unit : mm)

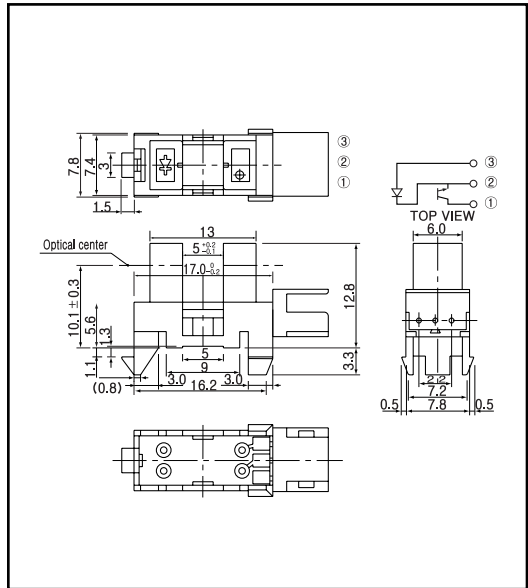

**MAXIMUM RATINGS**

(Ta=25 )

	Item	Symbol	Rating	Unit
Input	Power dissipation	$P_D$	100	mW
	Reverse voltage	$V_R$	5	V
	Forward current	$I_F$	60	mA
	Pulse forward current <sup>*1</sup>	$I_{FP}$	1	A
Output	Collector power dissipation	$P_C$	100	mW
	Collector current	$I_C$	40	mA
	C - E voltage	$V_{CE0}$	30	V
	E - C voltage	$V_{ECO}$	5	V
	Operating temp.	$T_{opr.}$ <sup>*2</sup>	- 20 ~ +85	
	Storage temp.	$T_{stg.}$ <sup>*2</sup>	- 30 ~ +85	

\*1. t w 100  $\mu$ sec.period :T=10msec.

\*2. The connector shall be inserted or pulled out at normal temperature

**ELECTRO-OPTICAL CHARACTERISTICS**

(Ta=25 )

	Item	Symbol	Conditions	Min.	Typ.	Max.	Unit.
Input	Forward voltage	$V_F$	$I_F=30mA$		1.2	1.5	V
	Reverse current	$I_R$	$V_R=5V$			10	$\mu A$
	Capacitance	$C_t$	$V=0, f=1KHz$		25		pF
	Peak wavelength	$\lambda_p$			940		nm
Output	Collector dark current	$I_{CEO}$	$V_{CE}=10V$			0.1	$\mu A$
Light current		$I_L$	$V_{CE}=5V, I_F=20mA$	0.6			mA
C - E saturation voltage		$V_{CE(sat)}$	$I_F=30mA, I_C=0.1mA$			0.4	V
Switching speeds	Rise time	$t_r$	$V_{CC}=5V, I_L=2mA$		5		$\mu$ sec.
	Fall time	$t_f$	$R_L=100k$		5		$\mu$ sec.

Photo interrupters(Transmissive)

SG - 203

**Collector power dissipation Vs. Ambient temperature**

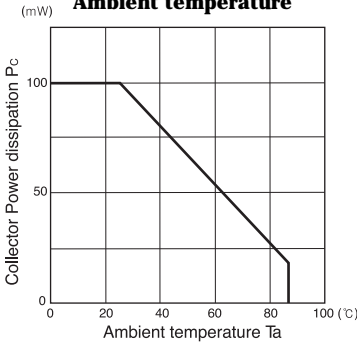

**Forward current Vs. Forward voltage**

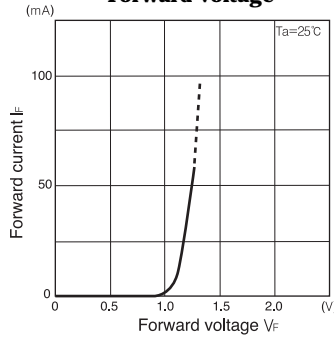

**Light current Vs. Forward current**

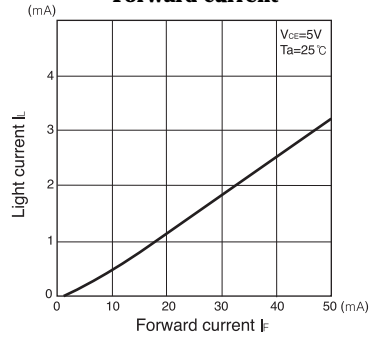

**Light current Vs. Collector-Emitter voltage**

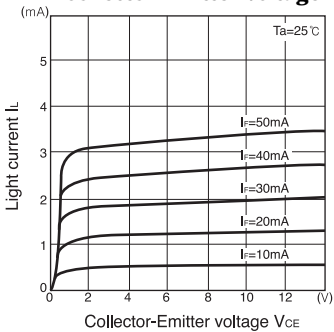

**Relative light current Vs. Ambient temperature**

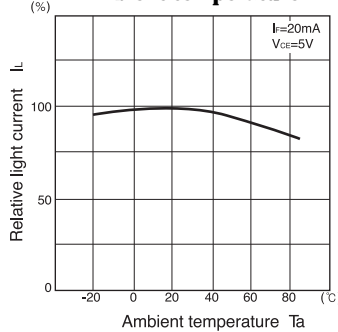

**Dark current Vs. Ambient temperature**

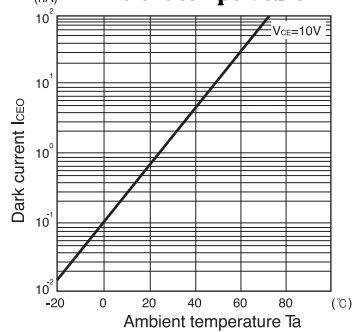

**Switching time Vs. Load resistance**

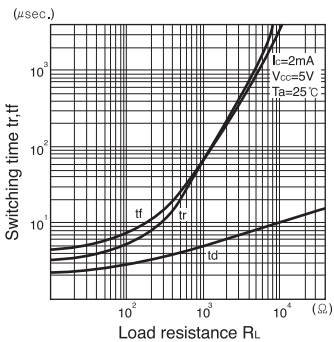

**Relative light current Vs. Moving distance**

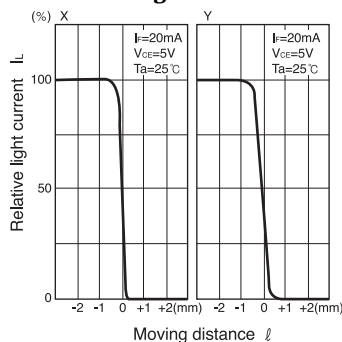

Switching time measurement circuit

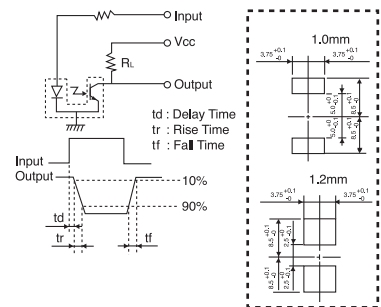

Method of measuring position characteristic

