

Safety Photoelectric Switch

E3FS

*Safety design for category 2.
Suitable for detecting human
bodies in hazardous area.*



Main features

- The E3FS is a Type 2 Safety Single Beam intended to be used with the control unit F3SP-U1P-TGR for the control system of a machine to category 2, 1 or B as defined in the European standard EN 954-1.
- Compliance with Machinery directive: No. 98/37/EC, EMC Directive: No. 89/336/EEC, EN 61496-1 (06/98) (Type 2 ESPE), and IEC61496-2 (1997) (Type 2 Active Optoelectronic Protection device).
- Approved by TÜV Product Service (Notified Body) as Type 2 ESPE (Electro-Sensitive-Protective-Equipment), Type 2 AOPD (Active Optoelectronic Protection device) and CE marking.
- Pursuing safety with high level of safety design and FMEA.
- System configuration of up to four units is possible.
- With the control unit F3SP-U1P-TGR, two different muting functions can be selected for each set of E3FS separately.
- Compact and space-saving (M18 DIN-sized threaded cylindrical housing, axial type)
- Housing materials: plastic and nickel brass
- Connection: Pre-wired and M12 plug
- High enclosure ratings (IP67)
- Sensing distance 10m

Selection guide

DC-Switching Models



		Plastic		Nickel Brass (-M)	
		Cable Type	Plug Type	Cable Type	Plug Type
Method of detection		Single beam	Single beam	Single beam	Single beam
Rated sensing distance		10m	10m	10m	10m
Light-ON/Dark-ON (selectable)	PNP	E3FS-10B4	E3FS-10B4-P1	E3FS-10B4-M	E3FS-10B4-M1-M

Accessories (Order Separately)

Name	Model
Mounting bracket	Y92E-B18
Muting control unit	F3SP-U1P-TGR

For detailed information about the mounting bracket, refer to the main chapter “Accessories” at the end of the document.
 For detailed information about the muting control unit, refer to the specification sheet E502-E2-01.

Connectors (Order Separately)

Cord	Appearance		Cord length	Model
Standard	Straight (4 conductor)		2 m	XS2F-D421-D80-A
			5 m	XS2F-D421-G80-A
	L-shape (4 conductor)		2 m	XS2F-D422-D80-A
			5 m	XS2F-D422-G80-A

Ordering Information: type list

DC-Switching Models, plastic

Pos.	Code	Sensing method, sensing distance	Connection (cable-length)	Output/ Input config.	Enclosure ratings	Comments
1	E3FS-10B4 2M	Through beam, 10 m	Pre-wired (2 m)*	PNP	IP67	Receiver and Emitter
2	E3FS-10B4-P1	Through beam, 10 m	Connector	PNP	IP67	Receiver and Emitter

* Other cable lengths available by special order

DC-Switching Models, metal

Pos.	Code	Sensing method, sensing range	Connection (cable-length)	Output/ Input config.	Enclosure ratings	Comments
1	E3FS-10B4-M 2M	Through beam, 10 m	Pre-wired (2 m)*	PNP	IP67	Receiver and Emitter
2	E3FS-10B4-M1-M	Through beam, 10 m	Connector	PNP	IP67	Receiver and Emitter

* Other cable lengths available by special order

Remarks to enclosure ratings:

The enclosure ratings IP67 of OMRON internal standard correspond to a higher test requirements than the official standard IEC 60 529 :

- The sensors rated IP67 have special enclosure protection. In this case, the sensors have passed the OMRON-internal heat shock test (see below) before the IP67-test of IEC 60 529 (1m water height for 1 hour). Afterwards the sensors have been tested according to the OMRON-internal water-proof-test (see below).

Heat shock:

Alternating, fast temperature changes between -25°C and $+55^{\circ}\text{C}$ are executed for 5 cycles and 1 hour for each temperature. Functioning and isolation is checked afterwards.

Water proof:

After the heat shock test, the sensors are exposed alternating under water of $+2^{\circ}\text{C}$ and $+55^{\circ}\text{C}$ executing 20 cycles and 1 hour for each temperature. Functioning, water tightness and electrical isolation is checked afterwards.

Specification of the E3FS types

DC Switching Models

Item		Emitter E3FS-10LB...	Receiver E3FS-10DB4...
Method of detection		Single beam	
Power supply voltage		12 to 24V DC +/- 10% (ripple (p-p) 10%)	
Current consumption (max.)		50 mA	25 mA
Rated sensing distance		10 m (Function reserve: +20%)	
Standard object		Opaque 11 mm min.	
Operation angle		+/- 5° (at 3 m)	
Response time		2.0 ms	
Control output		Transistor output PNP or NPN 100 mA max residual voltage: 2 V max at 100 mA (for PNP and NPN type)	
Test input (Emitter)	E3FS-10B ____ (PNP)	Vcc to Vcc-2,5 V : Emitting OFF (Sink current: 3 mA max.) Open or 0 to 2,5 V: Emitting ON (Leakage current: 0,1 mA max.)	
Mode selection input (Receiver)		Connection to Vcc: Light ON (ON when incident) Connection to 0 V: Dark ON (ON when interrupt)	
Power reset time		100 ms	
Ambient illumination		Incandescent lamp: 3000 lx max. Sunlight: 10000 lx max.	
Ambient temperature [9]		Operating: -25 to 55°C; Storage: -30 to 70°C	
Ambient humidity		Operating: 35% to 95%; Storage: 35% to 95%	
Insulation resistance		20 MΩ min. at 500 V DC between current carrying parts and case	
Dielectric strength		1000 V AC, 50/60 Hz for 1 min between current carrying parts and case	
Vibration resistance	Durability	10 to 55 Hz, 1.5 mm double amplitude, each X, Y, Z direction 2 hours	
	Operation limit	10 to 55 Hz, 0,7 mm double amplitude, each X, Y, Z direction 50 min	
Shock resistance	Durability	500 m/s ² (approx. 50 g) each X, Y, Z directions for 3 times	
	Operation limit	100 m/s ² (approx. 10 g) each X, Y, Z directions for 1,000 times	
Enclosure ratings		IP67	
Light source		Infrared	
Indicators		Emitter: Orange / Light emission Receiver: Green / ON-state, Red / OFF-state	
Sensitivity adjustment		Fixed	
Connection method		2 m pre-wired cable or connector	
Operation mode		Light-ON or Dark-ON selectable by wiring	
Weight for set Plastic case Metal case		Pre-wired cable models: Approx. 150 g Approx. 205 g	Connector models: Approx. 55 g Approx. 125 g
Circuit protection		Output short-circuit and power supply reverse polarity	
Housing materials		Plastic, Nickel brass	

Engineering Data – Sensing Range

DC-Switching Models

Through-beam type (E3FS-104-)

Sensing range

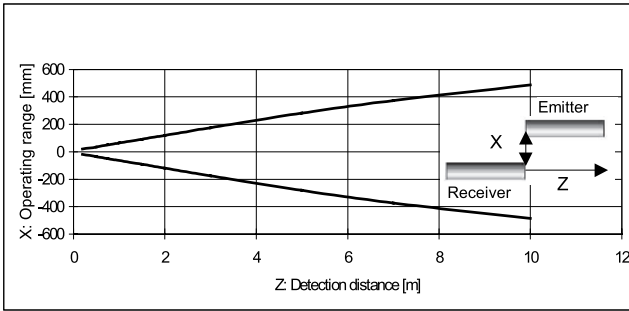

Mutual interference range

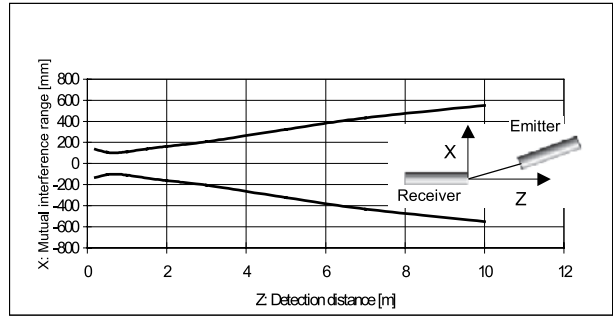

Excess gain ratio

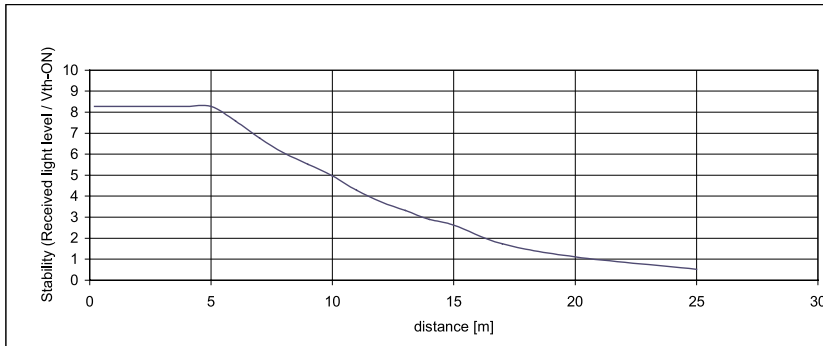

Operating Instructions

Output Circuit















PNP type

Model	Connection method	Output transistor	Output circuit
<p>E3FS-10DB4 2M E3FS-10DB4-P1 E3FS-10DB4-M 2M E3FS-10DB4-M1-M</p>	<p>Connect the pink and brown cords</p>	<p>ON when light is incident (Light-ON)</p>	
<p>Receiver circuit</p>	<p>Connect the pink and blue cords</p>	<p>ON when light is interrupted (Dark-ON)</p>	
<p>E3FS-10LB 2M E3FS-10LB-P1 E3FS-10LB-M 2M E3FS-10LB-M1-M</p> <p>Emitter circuit</p>			

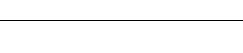
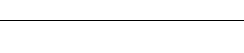
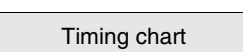





E3FS

Timing Chart

Output mode and timing chart

Receiver connection		Connect Pink (2) to Brown(1)	Connect Pink (2) to Blue (3)
Mode of output		ON when Incident (Light ON)	ON when interrupted (Dark ON)
Light Incident			
Light interrupted			
Indicator	Green		
	Red		
Control output	ON		
	OFF		
Load (Relay)	ON		
	OFF		

Emitting timing chart

		Timing chart
Test input	ON	
	OFF	
Light emission	ON	
	OFF	
Indicator	ON	
	OFF	

Terminals/Connections

Receiver

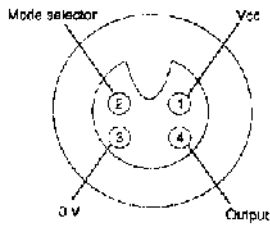

Emitter

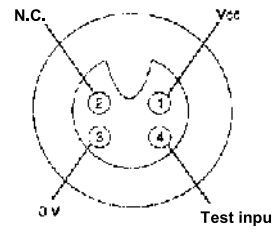

Accessories (order separately)

Mounting tools

Y92E-B18 Mounting Bracket

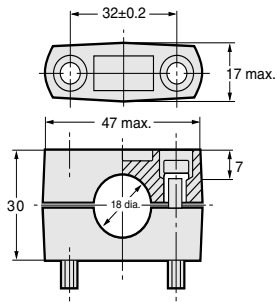
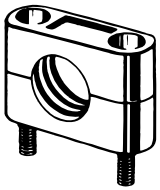

Note: Hexagonal bolt: M5 x 32 mm
Material: plastic

Dimensions

Note: All units are in millimeters unless otherwise indicated

Plastic housing

Cable type:

E3FS-10LB

E3FS-10DB4

Connector type:

E3FS-10LB-P1

E3FS-10DB4-P1

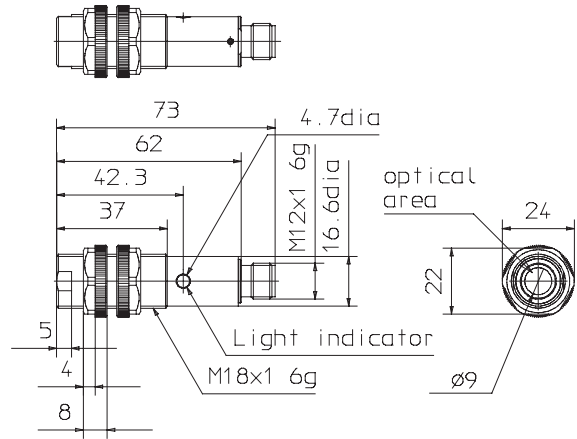
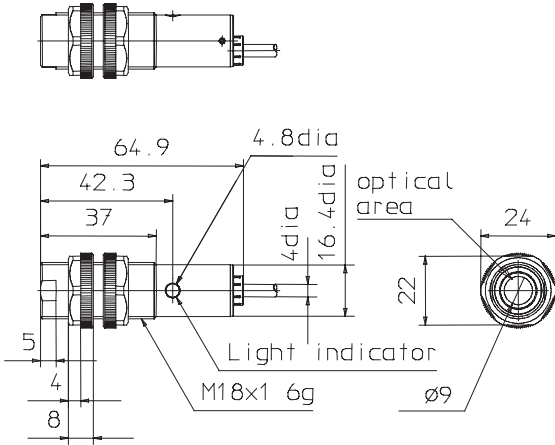

Metallic housing

Cable type:

E3FS-10LB-M

E3FS-10DB4-M

Connector type:

E3FS-10LB-M1-M

E3FS-10DB4-M1-M

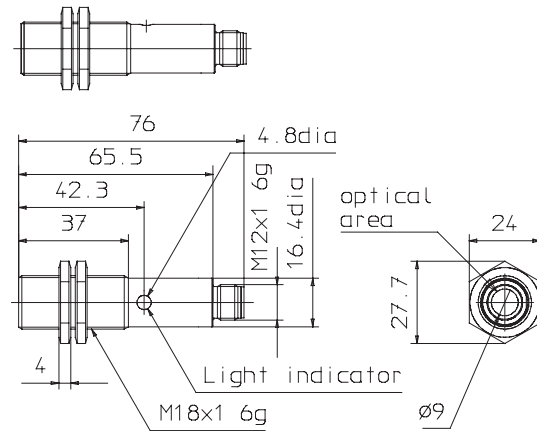
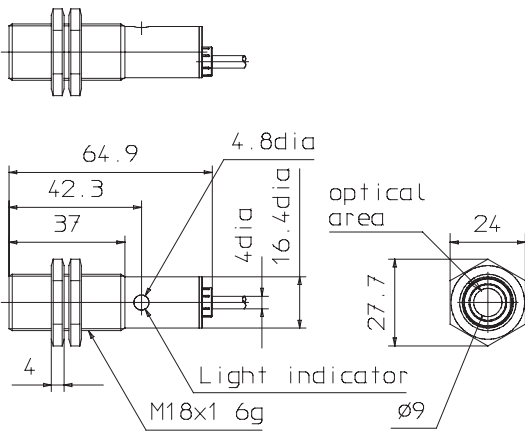

Precautions

WARNING

Indicates a potentially hazardous situation which, if not avoided, could result in death or serious injury. Indicates prohibited actions.

WARNING

When the E3FS is used without a safety control unit, do not use the E3FS as a safety device nor a part of safety systems for ensuring safety of persons.

When the E3FS is used without a safety control unit like the F3SP-U1P-TGR, it is in accordance with the requirements of the safety related control system to category B as defined in the European standard EN954-1.

The E3FS is in accordance with the requirements of the safety related control system to category 2 only when it is connected with a specified control unit.

E3FS-10B (PNP):

Type F3SP-U1P-TGR safety control unit must be used.

The F3SP-U1P-TGR executes a periodic test every 27 ms.

WARNING

Make sure that personnel operating the E3FS are knowledgeable about the machine on which it is installed.

Read this manual and the control unit manual completely.

Be sure the information provided is understood before attempting to operate the E3FS.

Multiple E3FSs must be sufficiently far from each other to avoid mutual interference.

Regarding the calculation of the safety distance, obey the control unit manual and related standards, e.g. EN999 when the E3FS is used as a safety device.

Regarding the avoidance of malfunction caused by shiny surface, obey the control unit manual when the E3FS is used as a safety device.

Use an opaque test piece with 11 mm in diameter and 200 mm or greater in effective length to check the detection capability.

Do not connect the E3FS to an AC or DC power supply with higher voltage than nominal 24 VDC. Otherwise the sensor may explode, burn, or cause electric shock.

The power supply must conform to regulatory requirements and standards, regarding EMC and electrical equipment safety, of the country where the E3FS is installed. For example, the power supply must fulfil EN60742 requirements for double insulation and must conform to EMC Directive and Low Voltage Directive in EU.

NOTICE

A load must not be shorted.

A load must not be used with current higher than the rating.

Do not apply the reversed supplied voltage.

Be sure to route the E3FS cable separated from high-potential power line or through an exclusive conduit.

E3FS must not be used in water.

The E3FS is ready to operate 100ms after the E3FS is turned ON. If the load and E3FS are connected to independent power supplies respectively, be sure to turn ON the sensor before turning the load ON.

To extend the cable, use a wire of 0.3mm² or more. However do not extend it more than 50m.

Do not use the E3FS in explosive or flammable gas.

Do not disassemble, repair, and modify the E3FS.

Do not exceed a torque of 2.0N·m (20Kgf·cm) when tightening mounting nuts for plastic models

20.0N·m (200Kgf·cm) when tightening mounting nuts for metal models.

For connector type of E3FS, make sure the cable connector is rated IP54 or higher.

Be sure to connect or disconnect the connector after turning OFF the E3FS.

Hold the connector cover to connect or disconnect the connector.

Secure the connector cover by hand. Do not use any pliers.

The proper tightening torque range should be checked according to connector specification. Be sure to tighten the connector securely.