

# Ground Sense Comparators

**BA10393F, BA10339F, BA10339FV, BA2903SF, BA2903SFV, BA2903SFVM  
BA2903F, BA2903FV, BA2903FVM, BA2901SF, BA2901SFV, BA2901SKN,  
BA2901F, BA2901FV, BA2901KN, BA8391G**

No.11049EBT18

● **Description**

General purpose BA8391G/BA10393/BA10339 family and high reliability BA2903/BA2901 family integrate one, two or four independent high gain voltage comparator. Some features are the wide operating voltage that is 2 to 36[V] (for BA8391G, BA10393, BA2903, BA2901 family), 3 to 36[V] (for BA10339 family) and low supply current. Therefore, this series is suitable for any application.

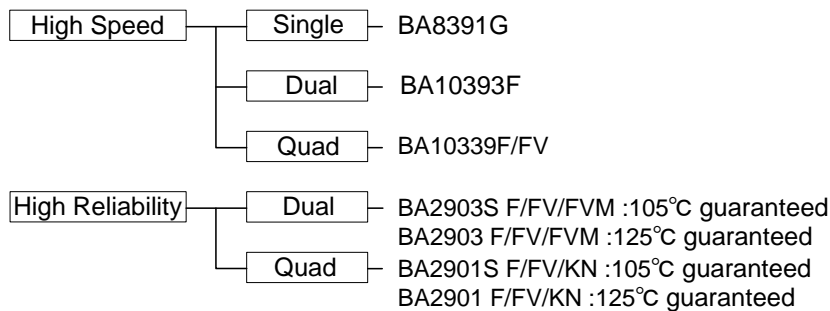

● **Features**

- 1) Operable with a signal power supply
- 2) Wide operating supply voltage
  - +2.0[V] ~ +36.0[V] (single supply) } (BA10393 family)
  - ±1.0[V] ~ ±18.0[V] (split supply) }
  - +3.0[V] ~ +36.0[V] (single supply) } (BA10339 family)
  - ±1.5[V] ~ ±18.0[V] (split supply) }
  - +2.0[V] ~ +36.0[V] (single supply) } (BA2903/BA2901 family)
  - ±1.0[V] ~ ±18.0[V] (split supply) }
- 3) Standard comparator pin-assignments
- 4) Input and output are operable ground sense
- 5) Internal ESD protection  
Human body model (HBM)±5000[V](Typ.)  
(BA8391/BA2903/BA2901 family)
- 6) Gold PAD  
(BA2903/BA2901 family)
- 7) Wide temperature range  
-40[°C] ~ +85[°C](BA8391G/BA10393/BA10339 family)  
-40[°C] ~ +105[°C](BA2903S/BA2901S family)  
-40[°C] ~ +125[°C](BA2903/BA2901 family)

● **Pin Assignment**

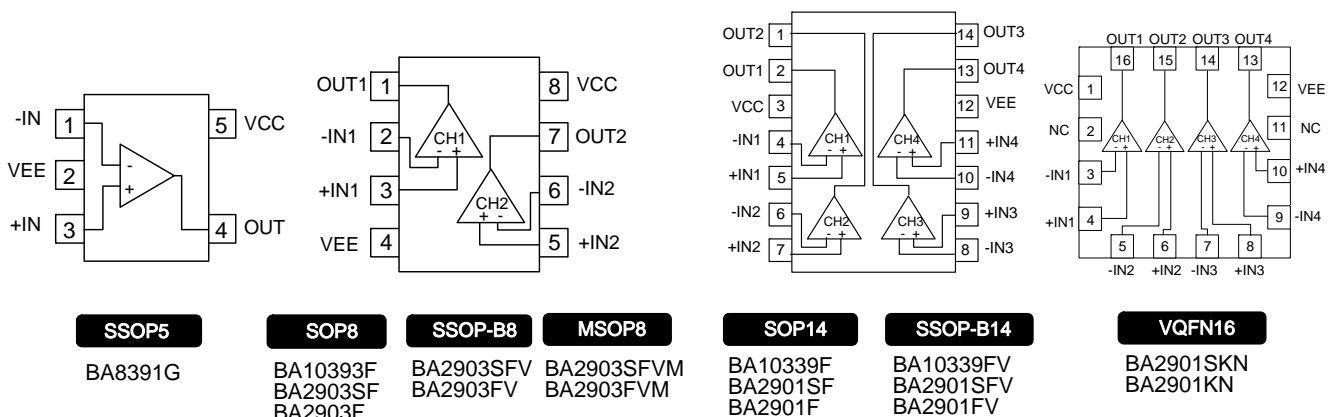

● Absolute Maximum Ratings (Ta=25[°C])

Parameter	Symbol	Ratings			Unit
		BA8391G	BA10393 family	BA10339 family	
Supply Voltage	VCC-VEE	+36			V
Differential Input Voltage <sup>(*1)</sup>	Vid	±36	VCC - VEE		V
Input Common-mode Voltage Range	Vicm	(VEE-0.3)~VEE+36	(VEE-0.3)~VCC		V
Operating Temperature Range	Topr	-40 ~ +85			°C
Storage Temperature Range	Tstg	-55 ~ +150	-55 ~ +125		°C
Maximum junction Temperature	Tjmax	+150	+125		°C

Note: Absolute maximum rating item indicates the condition which must not be exceeded.

Application if voltage in excess of absolute maximum rating or use out of absolute maximum rated temperature environment may cause deterioration of characteristics.

(\*1) The voltage difference between inverting input and non-inverting input is the differential input voltage. Then input terminal voltage is set to more than VEE.

● Electric Characteristics

OBA8391G (Unless otherwise specified VCC=+5[V], VEE=0[V], Ta=25[°C])

Parameter	Symbol	Temperature range	Limits			Unit	Condition
			BA8391G				
			Min.	Typ.	Max.		
Input Offset Voltage <sup>(*2) (*3)</sup>	Vio	25°C	-	2	7	mV	VOUT = 1.4[V]
		Full range	-	-	15		VCC = 5 ~ 36[V], VOUT = 1.4[V]
Input Offset Current <sup>(*2) (*3)</sup>	Iio	25°C	-	5	50	nA	VOUT = 1.4[V]
		Full range	-	-	200		
Input Bias Current <sup>(*2) (*3)</sup>	Ib	25°C	-	50	250	nA	VOUT = 1.4[V]
		Full range	-	-	500		
Input Common-mode Voltage Range	Vicm	25°C	0	-	VCC-1.5	V	-
Large Signal Voltage Gain	AV	25°C	88	100	-	dB	VCC=15[V], VOUT=1.4 ~ 11.4[V], RL = 15[kΩ], VRL = 15[V]
Supply Current <sup>(*3)</sup>	ICC	25°C	-	0.3	0.7	mA	VOUT = open
		Full range	-	-	1.3		VOUT = open, VCC = 36[V]
Output Sink Current <sup>(*4)</sup>	IOL	25°C	6	16	-	mA	VIN+ = 0[V], VIN- = 1[V], VOL = 1.5[V]
Output Saturation Voltage <sup>(*3)</sup> (Low level output voltage)	VOL	25°C	-	150	400	mV	VIN+ = 0[V], VIN- = 1[V], IOL = 4[mA]
		Full range	-	-	700		
Output Leakage Current <sup>(*3)</sup> (High level output voltage)	Ileak	25°C	-	0.1	-	nA	VIN+ = 1[V], VIN- = 0[V], VOH = 5[V]
		Full range	-	-	1	μA	VIN+ = 1[V], VIN- = 0[V], VOH = 36[V]
Response Time	Tre	25°C	-	1.3	-	μs	RL = 5.1[kΩ], VRL = 5[V], VIN=100[mVp-p], overdrive=5[mV]
							RL =5.1[kΩ], VRL=5[V], VIN=TTL Logic Swing, VREF = 1.4[V]

(\*2) Absolute value

(\*3) Full range Ta=-40 ~ +85[°C]

(\*4) Under high temperatures, please consider the power dissipation when selecting the output current.

When the output terminal is continuously shorted the output current reduces the internal temperature by flushing.

OBA10393 family(Unless otherwise specified VCC=+5[V], VEE=0[V], Ta=25[°C])

Parameter	Symbol	Temperature range	Limits			Unit	Condition
			BA10393 family				
			Min.	Typ.	Max.		
Input Offset Voltage <sup>(*5)</sup>	Vio	25°C	-	1	5	mV	VOUT = 1.4[V]
Input Offset Current <sup>(*5)</sup>	Iio	25°C	-	5	50	nA	VOUT = 1.4[V]
Input Bias Current <sup>(*6)</sup>	Ib	25°C	-	50	250	nA	VOUT = 1.4[V]
Input Common-mode Voltage Range	Vicm	25°C	0	-	VCC-1.5	V	-
Large Signal Voltage Gain	AV	25°C	93	106	-	dB	RL = 15[kΩ], VCC = 15[V], VRL = 15[V], VOUT = 1.4~11.4[V]
Supply Current	ICC	25°C	-	0.4	1	mA	RL = ∞ All Comparators
Output Sink Current	IOL	25°C	6	16	-	mA	VIN- = 1[V], VIN+ = 0[V], VOL = 1.5[V]
Output Saturation Voltage (Low level output voltage)	VOL	25°C	-	250	400	mV	VIN- = 1[V], VIN+ = 0[V], IOL = 4[mA]
Output Leakage Current (High level output voltage)	Ileak	25°C	-	0.1	-	μA	VIN- = 0[V], VIN+ = 1[V], VOH = 5[V]
		25°C	-	-	1	μA	VIN- = 0[V], VIN+ = 1[V], VOH = 36[V]
Response Time	Tre	25°C	-	1.3	-	μs	RL = 5.1[kΩ], VRL = 5[V] VIN=100[mVp-p],overdrive=5[mV]

(\*5) Absolute value

(\*6) Current Direction: Since first input stage is composed with PNP transistor, input bias current flows out of IC.

OBA10339 family(Unless otherwise specified VCC=+5[V], VEE=0[V], Ta=25[°C])

Parameter	Symbol	Temperature range	Limits			Unit	Condition
			BA10339 family				
			Min.	Typ.	Max.		
Input Offset Voltage <sup>(*7)</sup>	Vio	25°C	-	±1	±5	mV	VOUT = 1.4[V]
Input Offset Current <sup>(*7)</sup>	Iio	25°C	-	±5	±50	nA	VOUT = 1.4[V]
Input Bias Current <sup>(*8)</sup>	Ib	25°C	-	50	250	nA	VOUT = 1.4[V]
Input Common-mode Voltage Range	Vicm	25°C	0	-	VCC-1.5	V	-
Large Signal Voltage Gain	AV	25°C	93	106	-	dB	RL = 15[kΩ],VCC = 15[V]
Supply Current	ICC	25°C	-	0.8	2	mA	RL = ∞ All Comparators
Output Sink Current	IOL	25°C	6	16	-	mA	VIN- = 1[V], VIN+ = 0[V], VOUT = 1.5[V]
Output Saturation Voltage (Low level output voltage)	VOL	25°C	-	250	400	mV	VIN- = 1[V], VIN+ = 0[V], IOL = 4[mA]
Output Leakage Current (High level output voltage)	Ileak	25°C	-	0.1	-	μA	VIN- = 0[V], VIN+ = 1[V], VOUT = 5[V]
		25°C	-	-	1	μA	VIN- = 0[V], VIN+ = 1[V], VOUT = 36[V]
Response Time	Tre	25°C	-	1.3	-	μs	RL = 5.1[kΩ], VRL = 5[V] VIN=100[mVp-p],overdrive=5[mV]

(\*7) Absolute value

(\*8) Current Direction : Since first input stage is composed with PNP transistor, input bias current flows out of IC.

● Absolute Maximum Ratings (Ta=25[°C])

Parameter	Symbol	Ratings		Unit
		BA2903S family BA2901S family	BA2903 family BA2901 family	
Supply Voltage	VCC-VEE	+36		V
Differential Input Voltage <sup>(*9)</sup>	Vid	±36		V
Input Common-mode Voltage Range	Vicm	(VEE-0.3) ~ VEE+36		V
Operating Temperature Range	Topr	-40 ~ +105	-40 ~ +125	°C
Storage Temperature Range	Tstg	-55 ~ +150		°C
Maximum junction Temperature	Tjmax	+150		°C

Note: Absolute maximum rating item indicates the condition which must not be exceeded.

Application if voltage in excess of absolute maximum rating or use out of absolute maximum rated temperature environment may cause deterioration of characteristics.

(\*9) The voltage difference between inverting input and non-inverting input is the differential input voltage.

Then input terminal voltage is set to more than VEE.

OBA2903 family(Unless otherwise specified VCC=+5[V], VEE=0[V], Ta=25[°C])

Parameter	Symbol	Temperature range	Limits			Unit	Condition
			BA2903S F/FV/FVM BA2903F/FV/FVM				
			Min.	Typ.	Max.		
Input Offset Voltage <sup>(*10) (*11)</sup>	Vio	25°C	-	2	7	mV	VOUT = 1.4[V]
		Full range	-	-	15		VCC = 5 ~ 36[V], VOUT = 1.4[V]
Input Offset Current <sup>(*10) (*11)</sup>	Iio	25°C	-	5	50	nA	VOUT = 1.4[V]
		Full range	-	-	200		
Input Bias Current <sup>(*10) (*11)</sup>	Ib	25°C	-	50	250	nA	VOUT = 1.4[V]
		Full range	-	-	500		
Input Common-mode Voltage Range	Vicm	25°C	0	-	VCC-1.5	V	-
Large Signal Voltage Gain	AV	25°C	88	100	-	dB	VCC = 15[V], VOUT=1.4 ~ 11.4[V] RL = 15[kΩ], VRL = 15[V]
Supply Current <sup>(*11)</sup>	ICC	25°C	-	0.6	1	mA	VOUT = open
		Full range	-	-	2.5		VOUT = open, VCC = 36[V]
Output Sink Current <sup>(*12)</sup>	IOL	25°C	6	16	-	mA	VIN+ = 0[V], VIN- = 1[V], VOL = 1.5[V]
Output Saturation Voltage <sup>(*11)</sup> (Low level output voltage)	VOL	25°C	-	150	400	mV	VIN+ = 0[V], VIN- = 1[V], IOL = 4[mA]
		Full range	-	-	700		
Output Leakage Current <sup>(*11)</sup> (High level output voltage)	Ileak	25°C	-	0.1	-	μA	VIN+ = 1[V], VIN- = 0[V], VOH = 5[V]
		Full range	-	-	1		VIN+ = 1[V], VIN- = 0[V], VOH = 36[V]
Response Time	Tre	25°C	-	1.3	-	μs	RL = 5.1[kΩ], VRL = 5[V] VIN=100[mVp-p], overdrive=5[mV]
			-	0.4	-		RL=5.1[kΩ], VRL=5[V], VIN=TTL Logic Swing, VREF=1.4[V]

(\*10) Absolute value

(\*11) BA2903S family: Full range -40[°C] ~ +105[°C], BA2903family: Full range -40[°C] ~ +125[°C]

(\*12) Under high temperatures, please consider the power dissipation when selecting the output current.

When the output terminal is continuously shorted the output current reduces the internal temperature by flushing.

OBA2901 family(Unless otherwise specified VCC=+5[V], VEE=0[V], Ta=25[°C])

Parameter	Symbol	Temperature range	Limits			Unit	Condition
			BA2901S F/FV/FVM BA2901F/FV/FVM				
			Min.	Typ.	Max.		
Input Offset Voltage <sup>(*13) (*14)</sup>	Vio	25°C	-	2	7	mV	VOUT=1.4[V]
		Full range	-	-	15		VCC=5 ~ 36[V], VOUT=1.4[V]
Input Offset Current <sup>(*13) (*14)</sup>	Iio	25°C	-	5	50	nA	VOUT=1.4[V]
		Full range	-	-	200		
Input Bias Current <sup>(*13) (*14)</sup>	Ib	25°C	-	50	250	nA	VOUT=1.4[V]
		Full range	-	-	500		
Input Common-mode Voltage Range	Vicm	25°C	0	-	VCC-1.5	V	-
Large Signal Voltage Gain	AV	25°C	88	100	-	dB	VCC=15[V], VOUT=1.4 ~ 11.4[V] RL=15[kΩ], VRL=15[V]
Supply Current <sup>(*14)</sup>	ICC	25°C	-	0.8	2	mA	VOUT = open
		Full range	-	-	2.5		VOUT = open, VCC = 36[V]
Output Sink Current <sup>(*15)</sup>	IOL	25°C	6	16	-	mA	VIN+ = 0[V], VIN- = 1[V], VOL = 1.5[V]
Output Saturation Voltage <sup>(*14)</sup> (Low level output voltage)	VOL	25°C	-	150	400	mV	VIN+ = 0[V], VIN- = 1[V], IOL = 4[mA]
		Full range	-	-	700		
Output Leakage Current <sup>(*14)</sup> (High level output voltage)	Ileak	25°C	-	0.1	-	μA	VIN+ = 1[V], VIN- = 0[V], VOH = 5[V]
		Full range	-	-	1	μA	VIN+ = 1[V], VIN- = 0[V], VOH = 36[V]
Response Time	Tre	25°C	-	1.3	-	μs	RL = 5.1[kΩ], VRL = 5[V] VIN=100[mVp-p], overdrive=5[mV]
			-	0.4	-		RL=5.1[kΩ], VRL=5[V], VIN =TTL Logic Swing, VREF = 1.4[V]

(\*13) Absolute value

(\*14) BA2901S family : Full range -40 ~ 105°C ,BA2901 family : Full range -40 ~ +125°C

(\*15) Under high temperatures, please consider the power dissipation when selecting the output current.

When the output terminal is continuously shorted the output current reduces the internal temperature by flushing.

●Reference Data BA8391 family

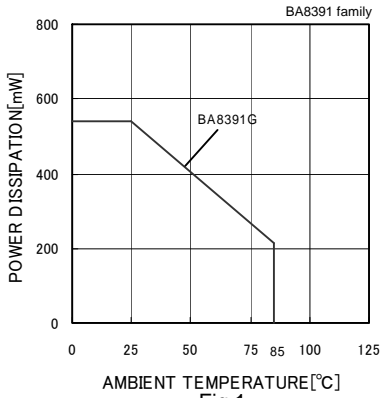

Fig.1 Derating Curve

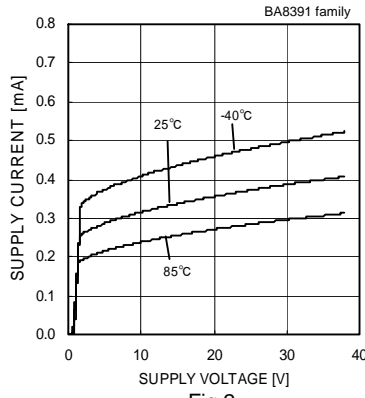

Fig.2 Supply Current - Supply Voltage

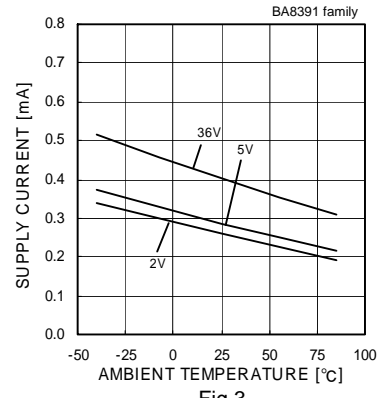

Fig.3 Supply Current - Ambient Temperature

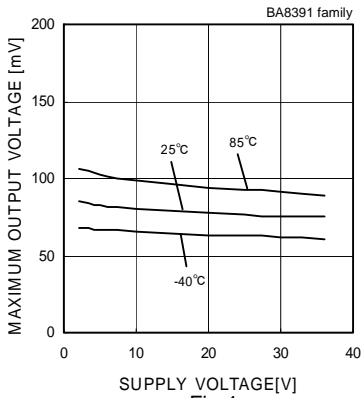

Fig.4 Output Saturation Voltage - Supply Voltage (IOL=4[mA])

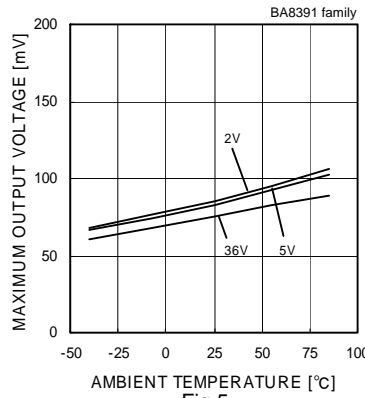

Fig.5 Output Saturation Voltage - Ambient Temperature (IOL=4[mA])

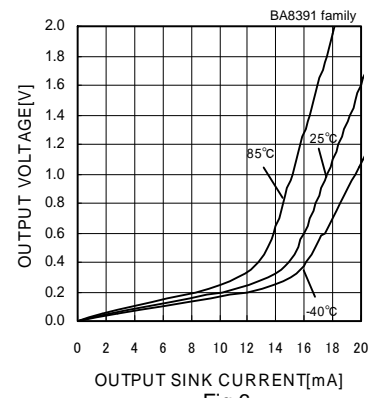

Fig.6 Low Level Output Voltage - Output Sink Current (VCC=5[V])

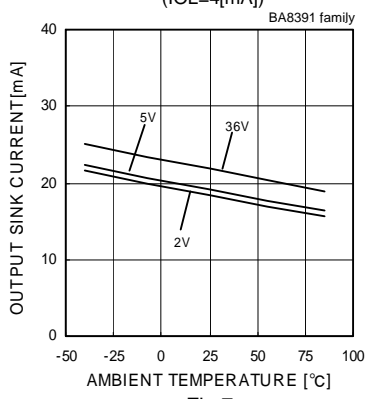

Fig.7 Output Sink Current - Ambient Temperature (VOUT=1.5[V])

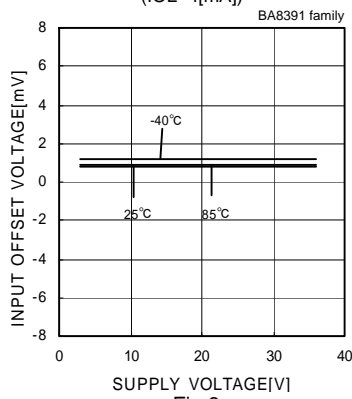

Fig.8 Input Offset Voltage - Supply Voltage

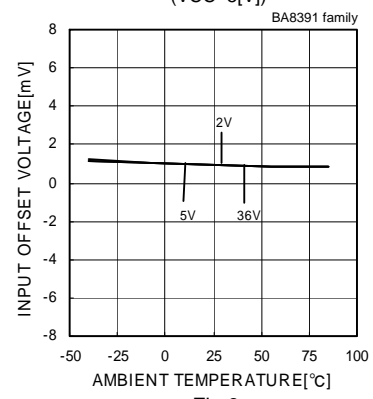

Fig.9 Input Offset Voltage - Ambient Temperature

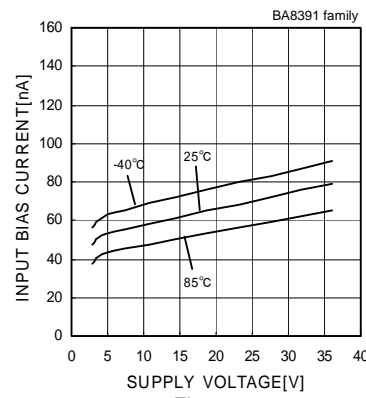

Fig.10 Input Bias Current - Supply Voltage

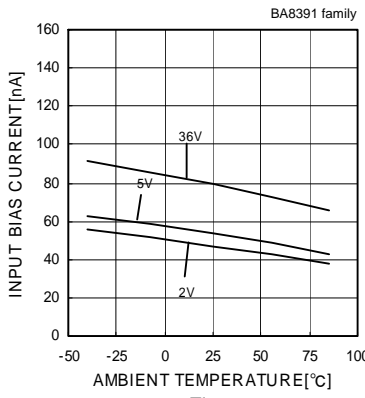

Fig.11 Input Bias Current - Ambient Temperature

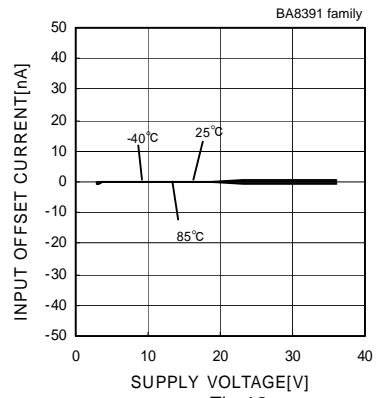

Fig.12 Input Offset Current - Supply Voltage

(\*)The data above is ability value of sample, it is not guaranteed. BA8391G:-40[°C]~+85[°C]

●Reference Data BA8391 family

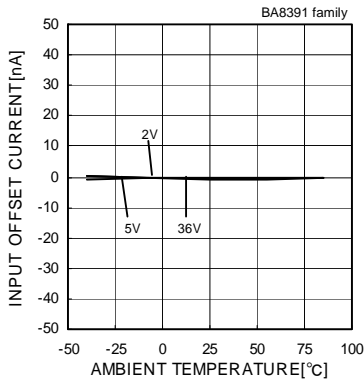

Fig.13

Input Offset Current - Ambient Temperature

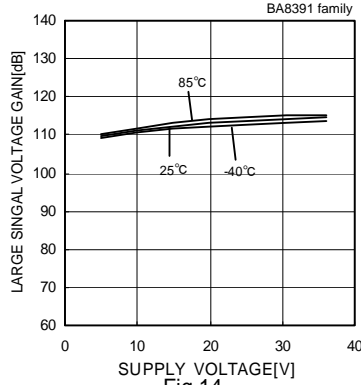

Fig.14

Large Signal Voltage Gain - Supply Voltage

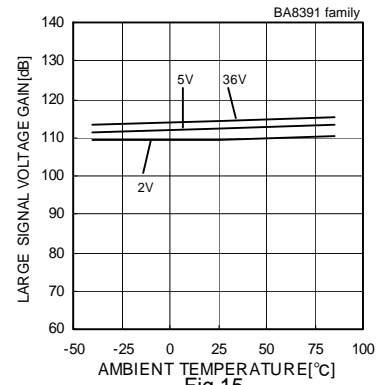

Fig.15

Large Signal Voltage Gain - Ambient Temperature

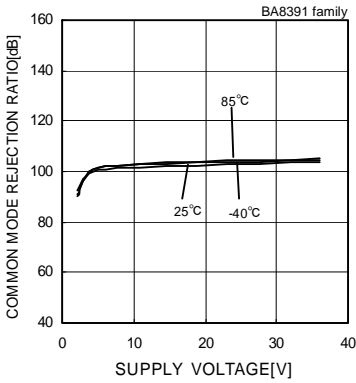

Fig.16

Common Mode Rejection Ratio - Supply Voltage

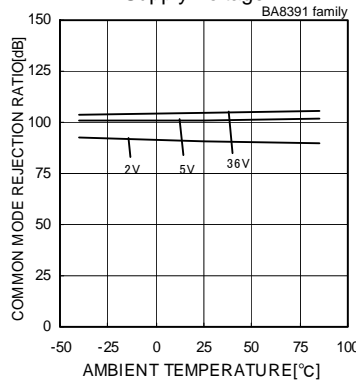

Fig.17

Common Mode Rejection Ratio - Ambient Temperature

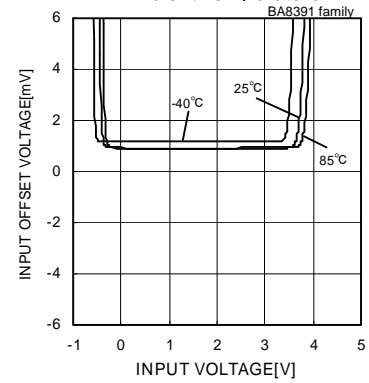

Fig.18

Input Offset Voltage - Input Voltage (VCC=5V)

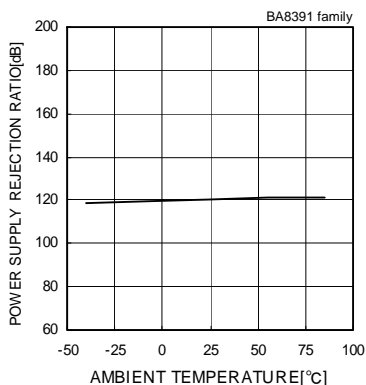

Fig.19

Power Supply Rejection Ratio - Ambient Temperature

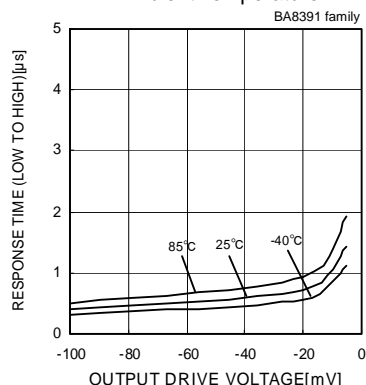

Fig.20

Response Time (Low to High) - Over Drive Voltage (VCC=5[V],VRL=5[V],RL=5.1[kΩ])

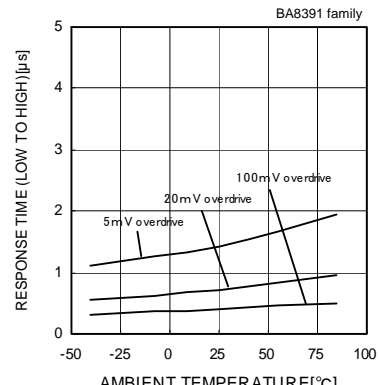

Fig.21

Response Time (Low to High) - Ambient Temperature (VCC=5[V],VRL=5[V],RL=5.1[kΩ])

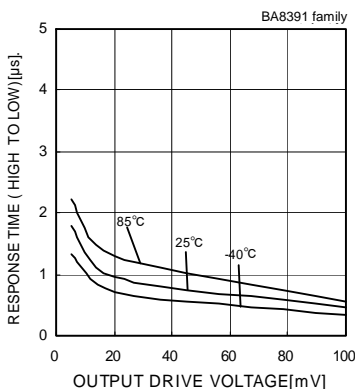

Fig.22

Response Time (High to Low) - Over Drive Voltage (VCC=5[V],VRL=5[V],RL=5.1[kΩ])

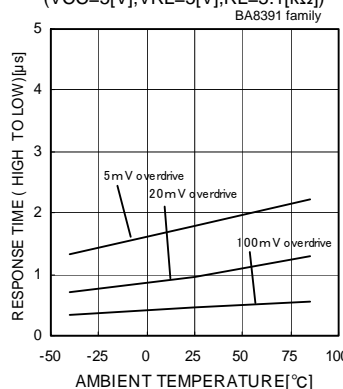

Fig.23

Response Time (High to Low) - Ambient Temperature (VCC=5[V],VRL=5[V],RL=5.1[kΩ])

(\*)The data above is ability value of sample, it is not guaranteed. BA8391G:-40[°C]~+85[°C]



●Reference Data BA10393 family

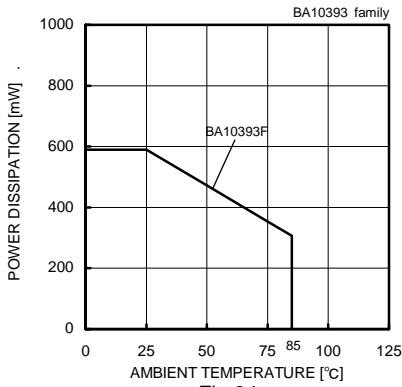

Fig.24 Derating Curve

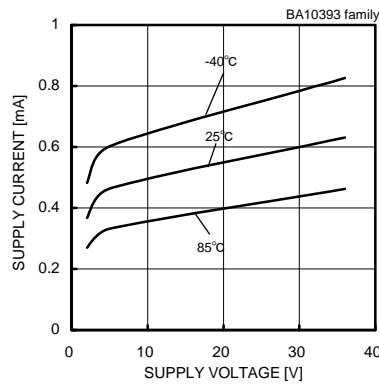

Fig.25 Supply Current - Supply Voltage

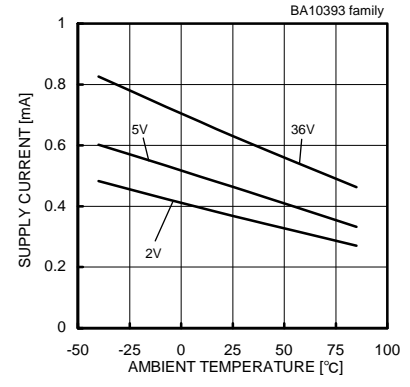

Fig.26 Supply Current - Ambient Temperature

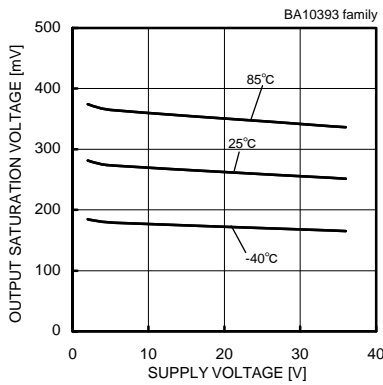

Fig.27 Output Saturation Voltage - Supply Voltage (IOL=4[mA])

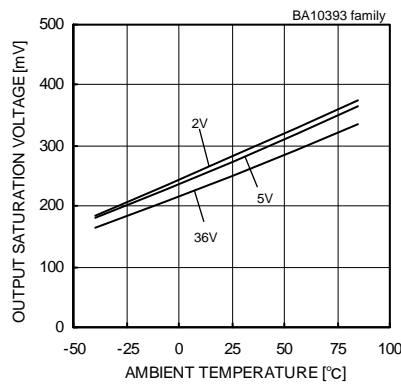

Fig.28 Output Saturation Voltage - Ambient Temperature (IOL=4[mA])

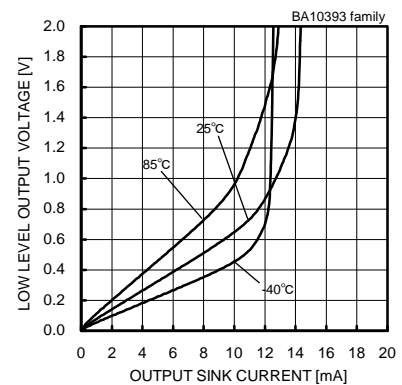

Fig.29 Low Level Output Voltage - Output Sink Current (VCC=5[V])

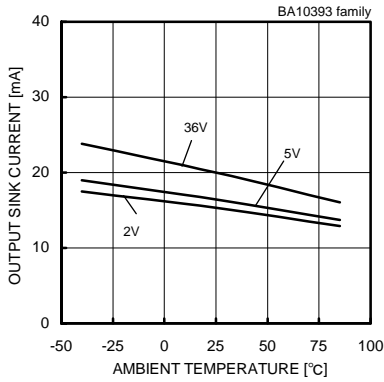

Fig.30 Output Sink Current - Ambient Temperature (VOUT=1.5[V])

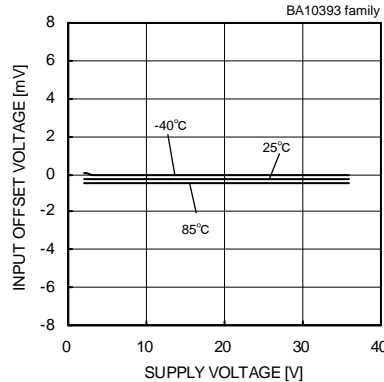

Fig.31 Input Offset Voltage - Supply Voltage

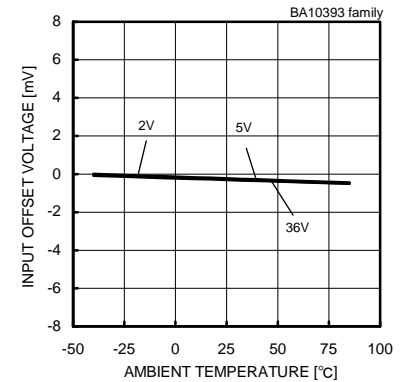

Fig.32 Input Offset Voltage - Ambient Temperature

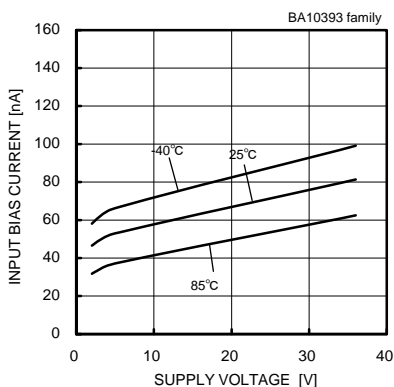

Fig.33 Input Bias Current - Supply Voltage

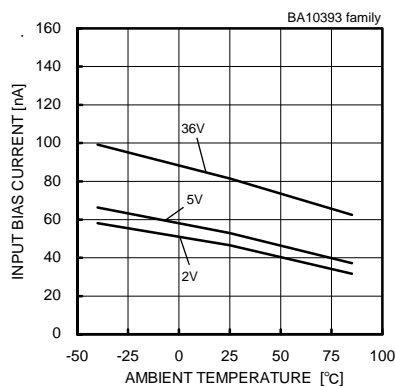

Fig.34 Input Bias Current - Ambient Temperature

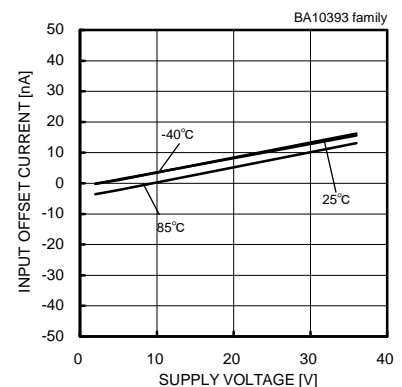

Fig.35 Input Offset Current - Supply Voltage

(\*The data above is ability value of sample, it is not guaranteed. BA10393F:-40[°C]~+85[°C])



●Reference Data BA10393 family

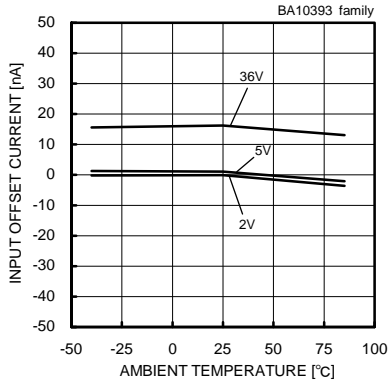

Fig.36  
Input Offset Current - Ambient Temperature

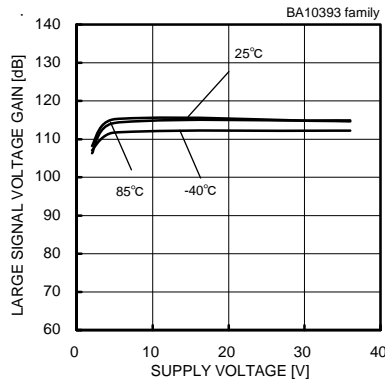

Fig.37  
Large Signal Voltage Gain  
- Supply Voltage

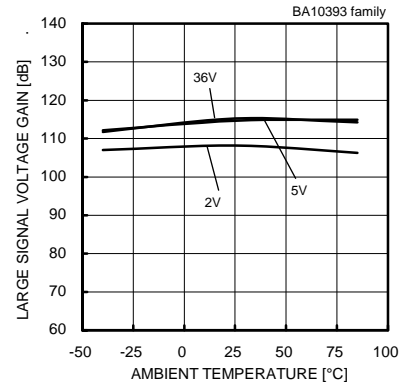

Fig.38  
Large Signal Voltage Gain  
- Ambient Temperature

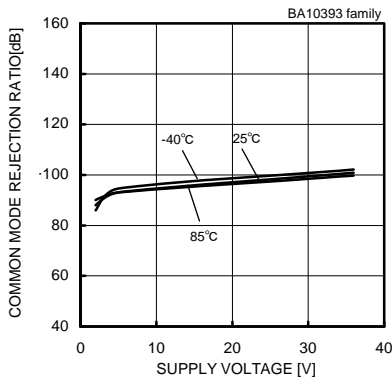

Fig.39  
Common Mode Rejection Ratio  
- Supply Voltage

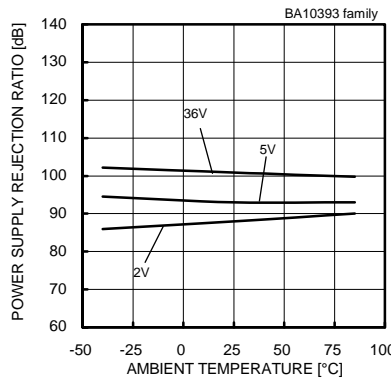

Fig.40  
Common Mode Rejection Ratio  
- Ambient Temperature

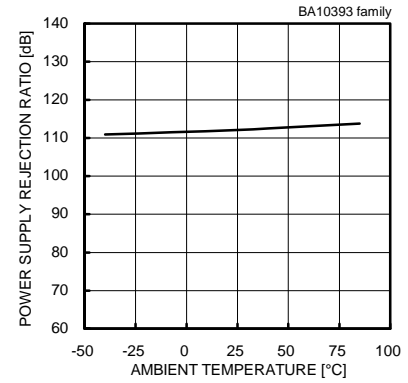

Fig.41  
Power Supply Rejection Ratio  
- Ambient Temperature

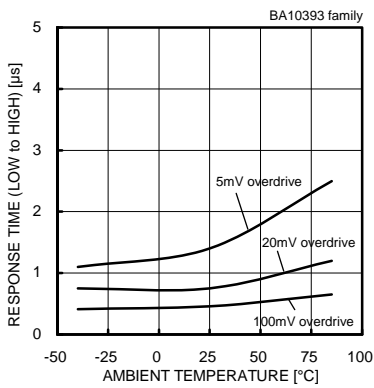

Fig.42  
Response Time (Low to High)  
- Ambient Temperature  
(VCC=5[V],VRL=5[V],RL=5.1[kΩ])

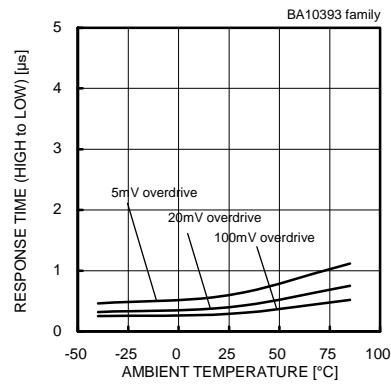

Fig.43  
Response Time (High to Low)  
- Ambient Temperature  
(VCC=5[V],VRL=5[V],RL=5.1[kΩ])

(\*)The data above is ability value of sample, it is not guaranteed. BA10393F:-40[°C]~+85[°C]

●Reference Data BA10339 family

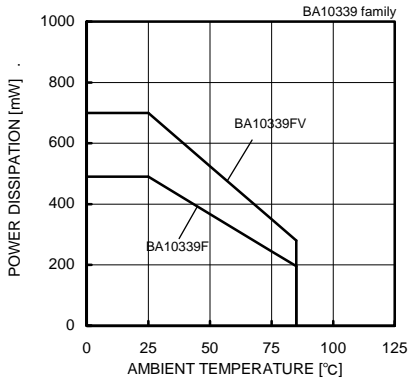

Fig.44 Derating Curve

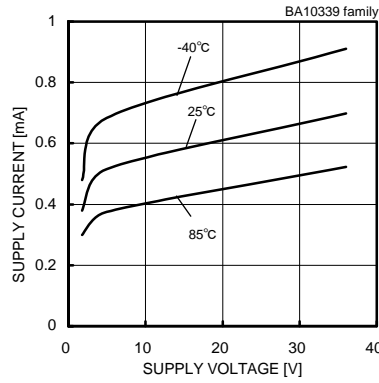

Fig.45 Supply Current - Supply Voltage

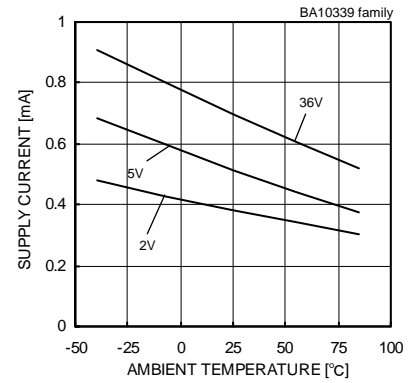

Fig.46 Supply Current - Ambient Temperature

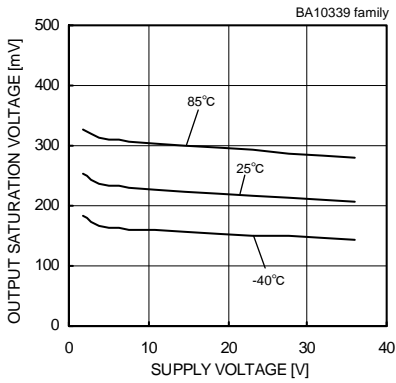

Fig.47 Output Saturation Voltage - Supply Voltage (IOL=4[mA])

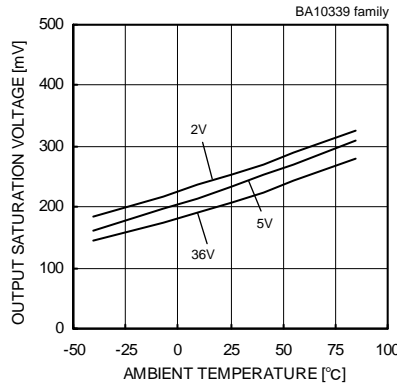

Fig.48 Output Saturation Voltage - Ambient Temperature (IOL=4[mA])

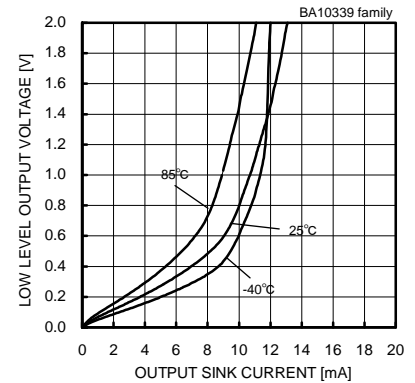

Fig.49 Low Level Output Voltage - Output Sink Current (VCC=5[V])

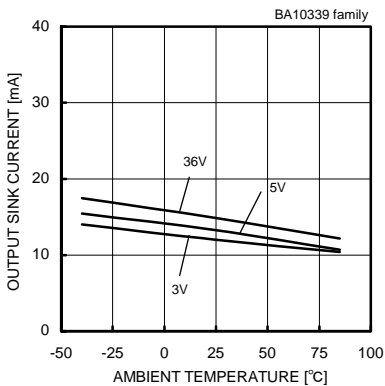

Fig.50 Output Sink Current - Ambient Temperature (VOUT=1.5[V])

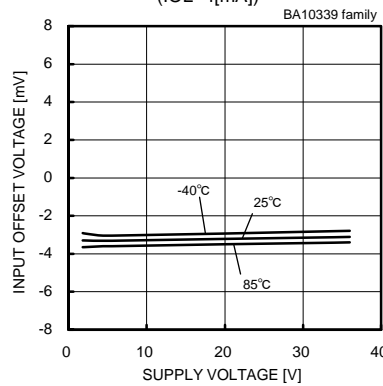

Fig.51 Input Offset Voltage - Supply Voltage

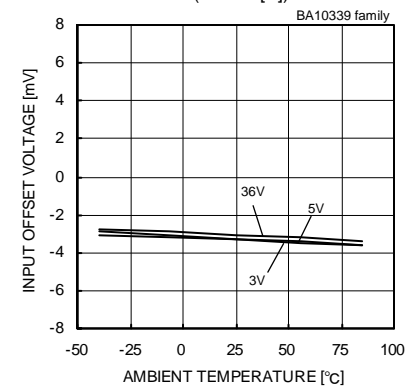

Fig.52 Input Offset Voltage - Ambient Temperature

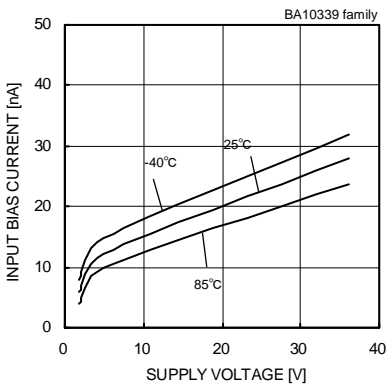

Fig.53 Input Bias Current - Supply Voltage

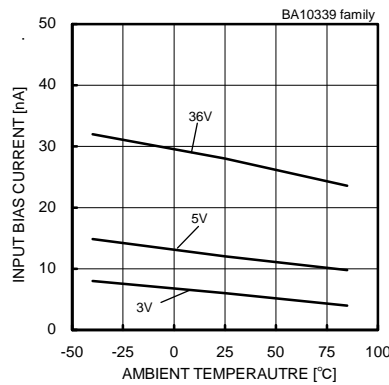

Fig.54 Input Bias Current - Ambient Temperature

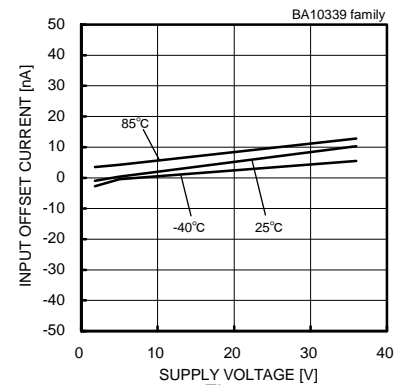

Fig.55 Input Offset Current - Supply Voltage

(\*)The data above is ability value of sample, it is not guaranteed. BA10339F/FV:-40[°C]~+85[°C]

●Reference Data BA10339 family

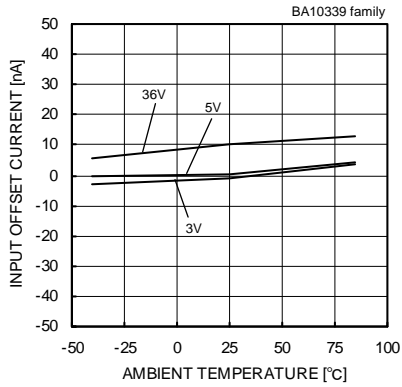

Fig.56  
Input Offset Current - Ambient Temperature

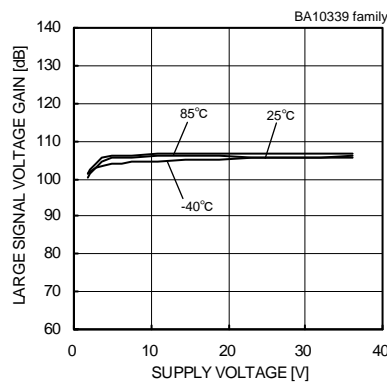

Fig.57  
Large Signal Voltage Gain - Supply Voltage

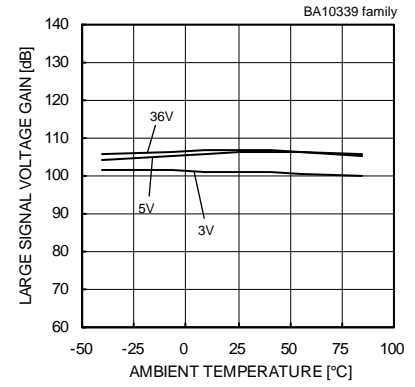

Fig.58  
Large Signal Voltage Gain - Ambient Temperature

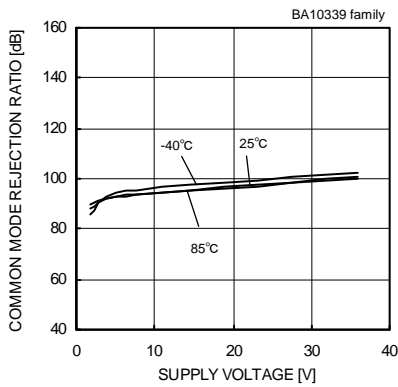

Fig.59  
Common Mode Rejection Ratio - Supply Voltage

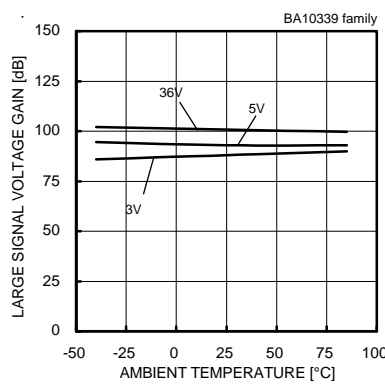

Fig.60  
Common Mode Rejection Ratio - Ambient Temperature

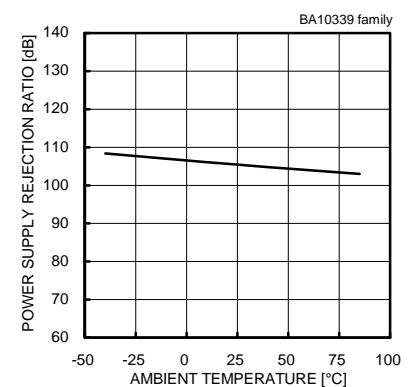

Fig.61  
Power Supply Rejection Ratio - Ambient Temperature

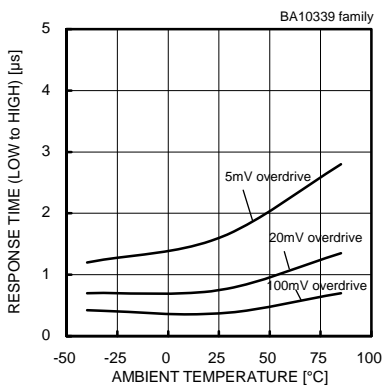

Fig.62  
Response Time (Low to High) - Ambient Temperature  
(VCC=5[V],VRL=5[V],RL=5.1[kΩ])

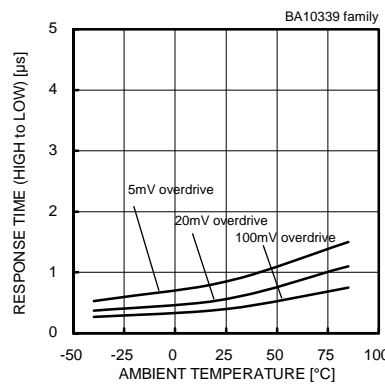

Fig.63  
Response Time (High to Low) - Ambient Temperature  
(VCC=5[V],VRL=5[V],RL=5.1[kΩ])

(\*The data above is ability value of sample, it is not guaranteed. BA10339F/FV:-40[°C]~+85[°C])

●Reference Data BA2903 family

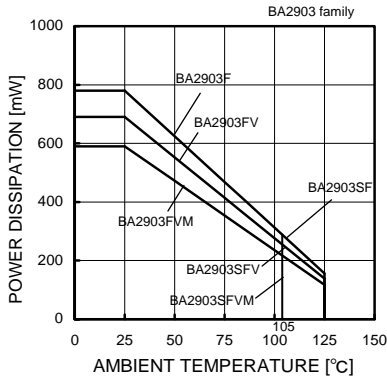

Fig.64 Derating Curve

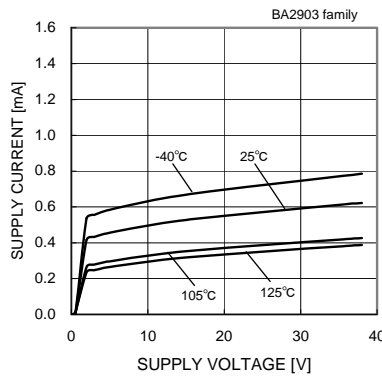

Fig.65 Supply Current - Supply Voltage

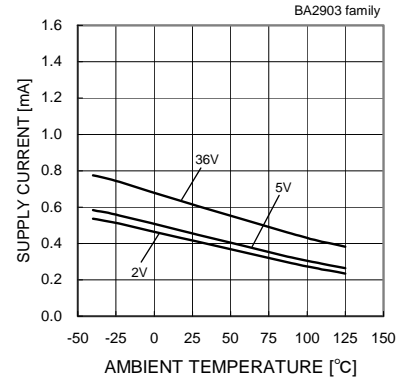

Fig.66 Supply Current - Ambient Temperature

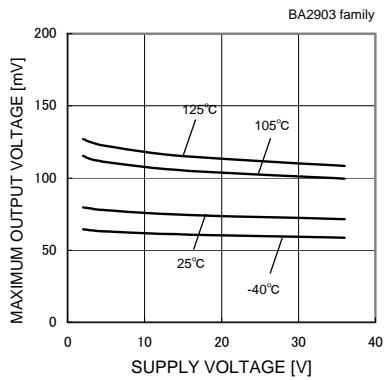

Fig.67 Output Saturation Voltage - Supply Voltage (IOL=4[mA])

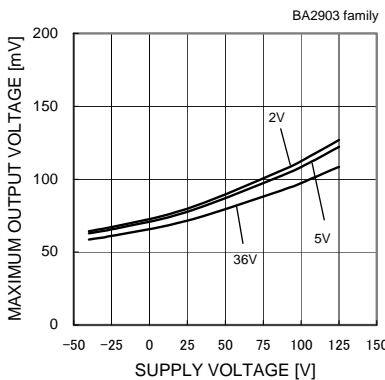

Fig.68 Output Saturation Voltage - Ambient Temperature (IOL=4[mA])

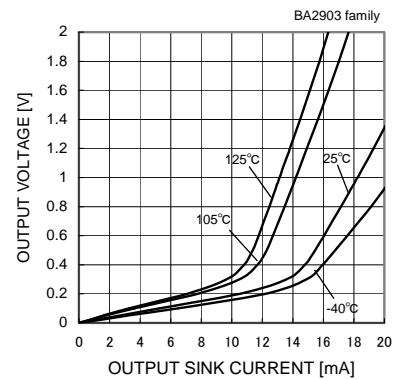

Fig.69 Low Level Output Voltage - Output Sink Current (VCC=5[V])

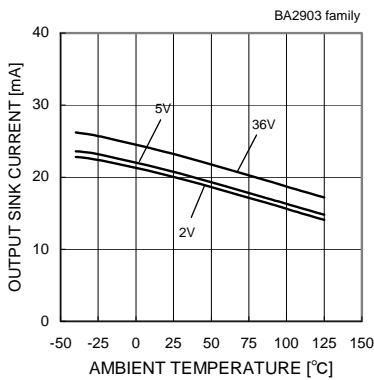

Fig.70 Output Sink Current - Ambient Temperature (VOUT=1.5[V])

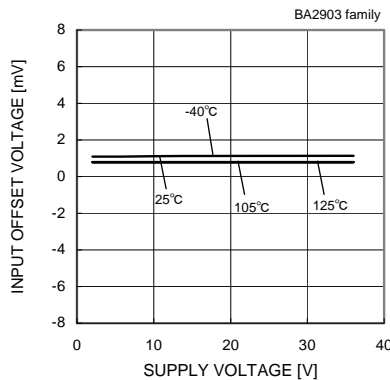

Fig.71 Input Offset Voltage - Supply Voltage

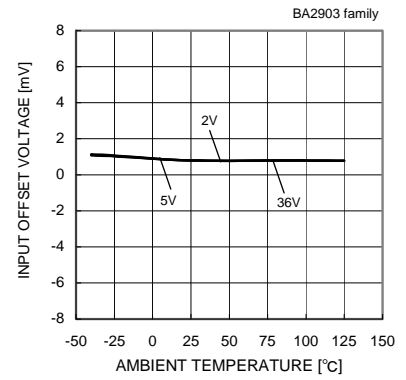

Fig.72 Input Offset Voltage - Ambient Temperature

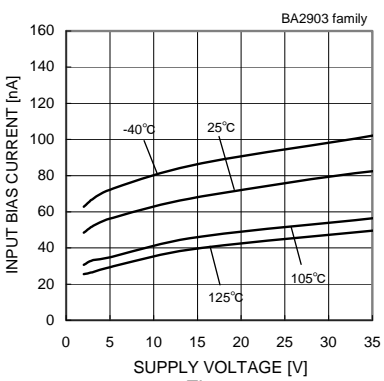

Fig.73 Input Bias Current - Supply Voltage

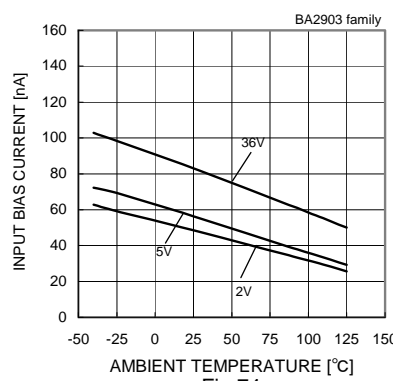

Fig.74 Input Bias Current - Ambient Temperature

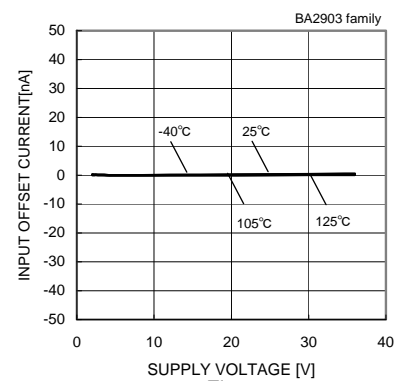

Fig.75 Input Offset Current - Supply Voltage

(\*)The data above is ability value of sample, it is not guaranteed. BA2903S:-40[°C]~+105[°C] BA2903:-40[°C]~+125[°C]

●Reference Data BA2903 family

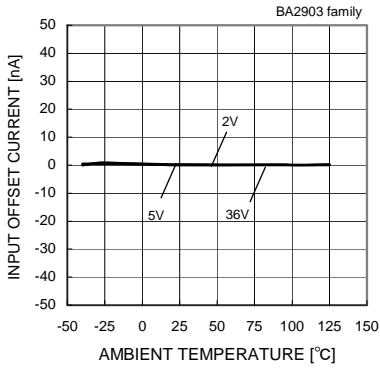

Fig.76  
Input Offset Current - Ambient Temperature

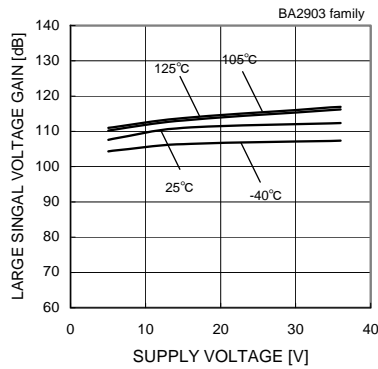

Fig.77  
Large Signal Voltage Gain  
- Supply Voltage

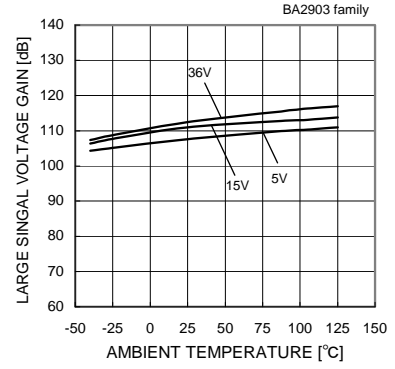

Fig.78  
Large Signal Voltage Gain  
- Ambient Temperature

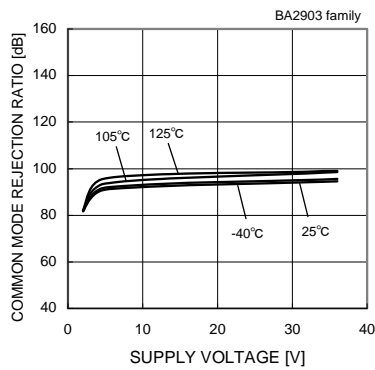

Fig.79  
Common Mode Rejection Ratio  
- Supply Voltage

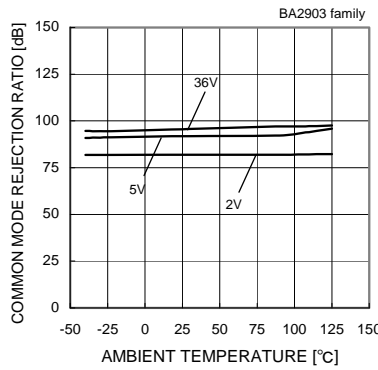

Fig.80  
Common Mode Rejection Ratio  
- Ambient Temperature

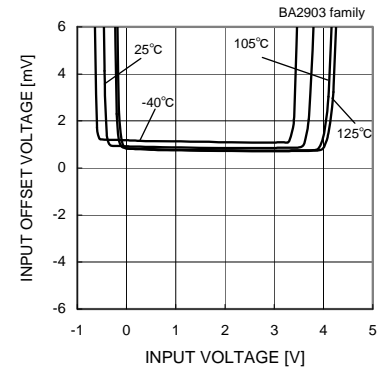

Fig.81  
Input Offset Voltage - Input Voltage  
(VCC=5V)

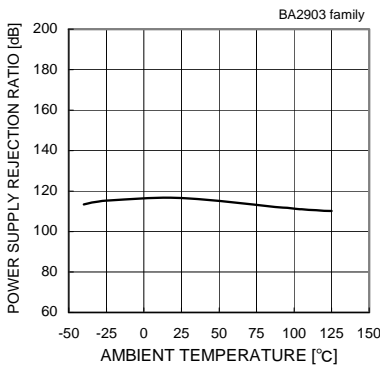

Fig.82  
Power Supply Rejection Ratio  
- Ambient Temperature

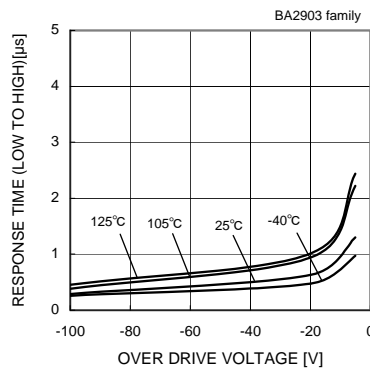

Fig.83  
Response Time (Low to High)  
- Over Drive Voltage  
(VCC=5[V],VRL=5[V],RL=5.1[kΩ])

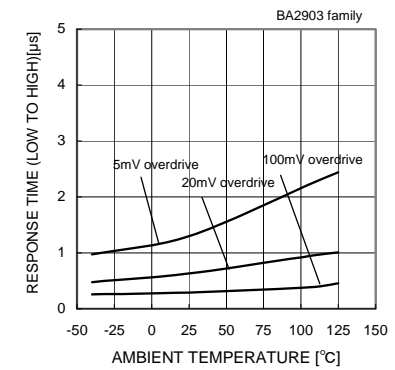

Fig.84  
Response Time (Low to High)  
- Ambient Temperature  
(VCC=5[V],VRL=5[V],RL=5.1[kΩ])

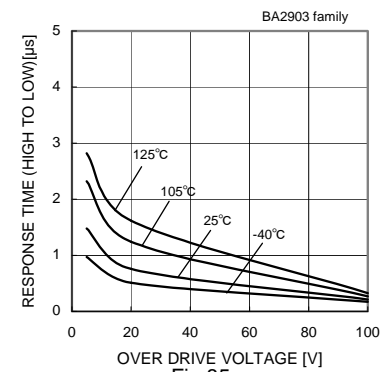

Fig.85  
Response Time (High to Low)  
- Over Drive Voltage  
(VCC=5[V],VRL=5[V],RL=5.1[kΩ])

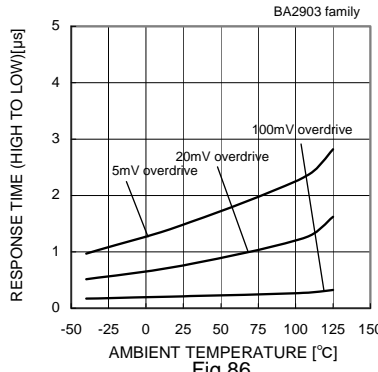

Fig.86  
Response Time (High to Low)  
- Ambient Temperature  
(VCC=5[V],VRL=5[V],RL=5.1[kΩ])

(\*)The data above is ability value of sample, it is not guaranteed. BA2903S:-40[°C]~+105[°C] BA2903:-40[°C]~+125[°C]

●Reference Data BA2901 family

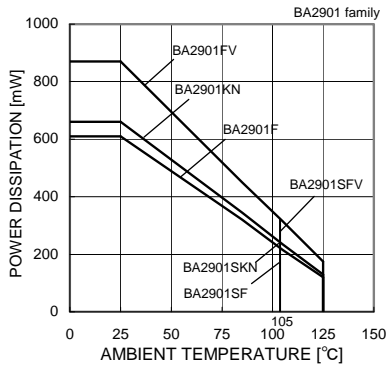

Fig.87 Derating Curve

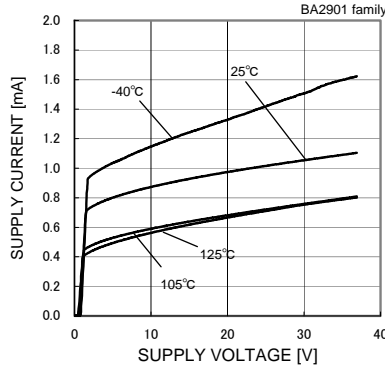

Fig.88 Supply Current - Supply Voltage

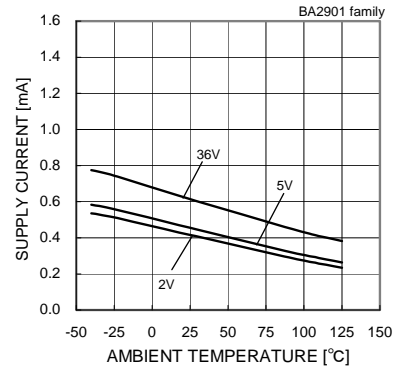

Fig.89 Supply Current - Ambient Temperature

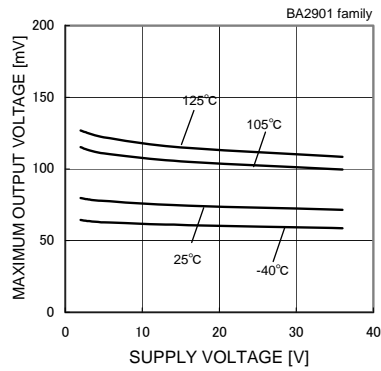

Fig.90 Output Saturation Voltage - Supply Voltage (IOL=4[mA])

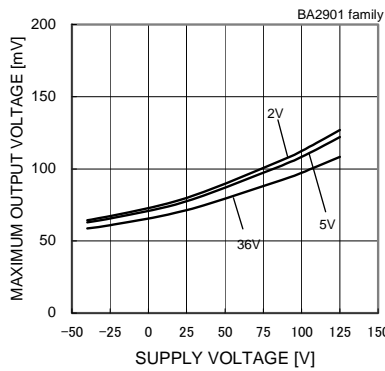

Fig.91 Output Saturation Voltage - Ambient Temperature (IOL=4[mA])

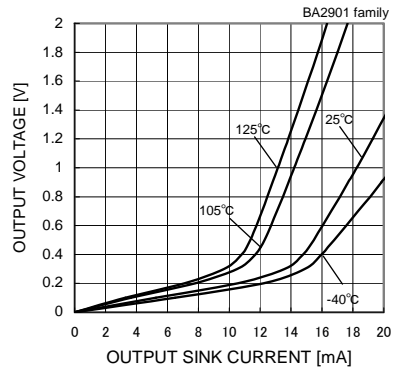

Fig.92 Low Level Output Voltage - Output Sink Current (VCC=5[V])

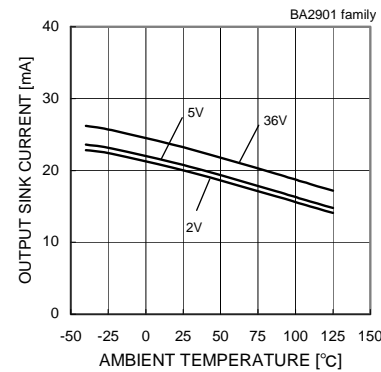

Fig.93 Output Sink Current - Ambient Temperature (VOUT=1.5[V])

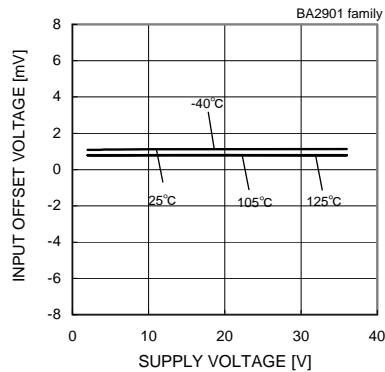

Fig.94 Input Offset Voltage - Supply Voltage

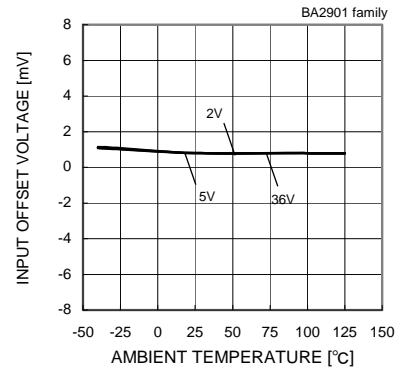

Fig.95 Input Offset Voltage - Ambient Temperature

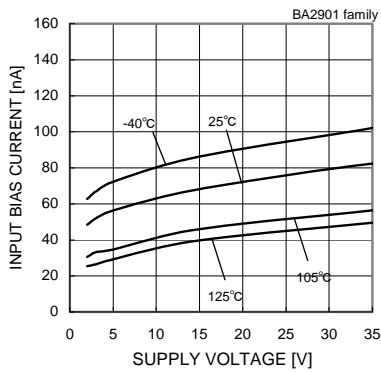

Fig.96 Input Bias Current - Supply Voltage

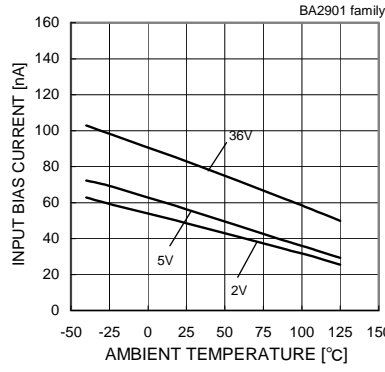

Fig.97 Input Bias Current - Ambient Temperature

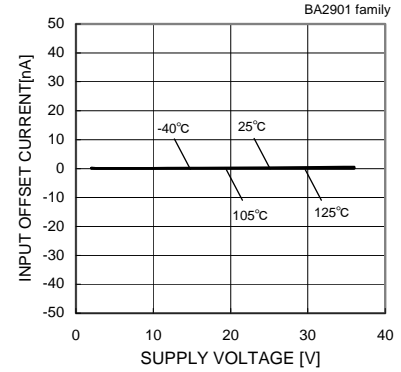

Fig.98 Input Offset Current - Supply Voltage

(\*)The data above is ability value of sample, it is not guaranteed. BA2901:-40[°C]~+125[°C] BA2901S:-40[°C]~+105[°C]

●Reference Data BA2901 family

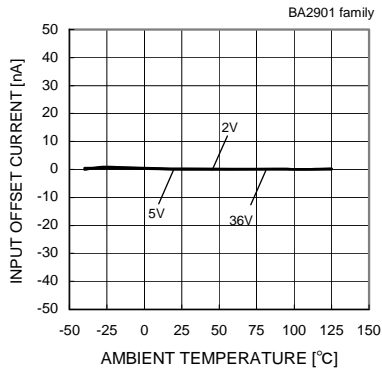

Fig.99  
Input Offset Current - Ambient Temperature

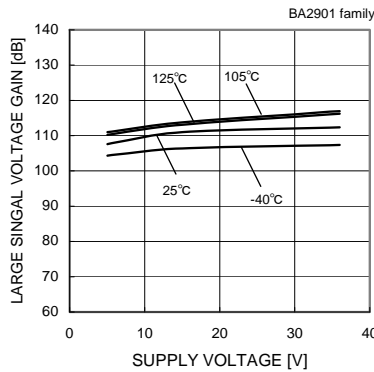

Fig.100  
Large Signal Voltage Gain  
- Supply Voltage

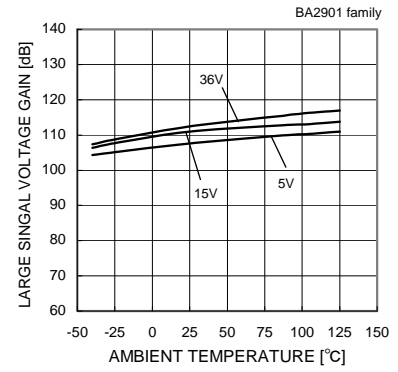

Fig.101  
Large Signal Voltage Gain  
- Ambient Temperature

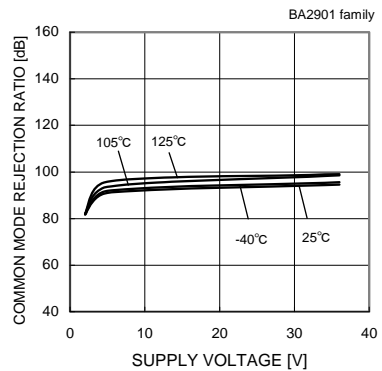

Fig.102  
Common Mode Rejection Ratio  
- Supply Voltage

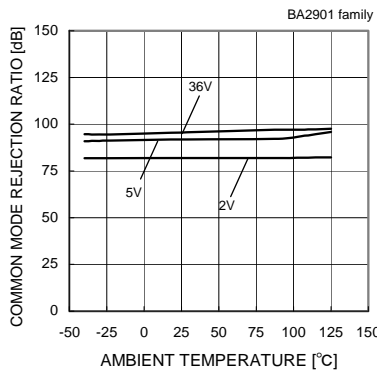

Fig.103  
Common Mode Rejection Ratio  
- Ambient Temperature

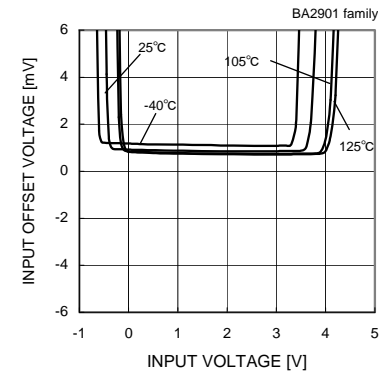

Fig.104  
Input Offset Voltage - Input Voltage  
(VCC=5V)

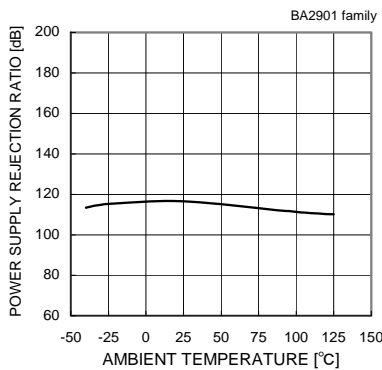

Fig.105  
Power Supply Rejection Ratio  
- Ambient Temperature

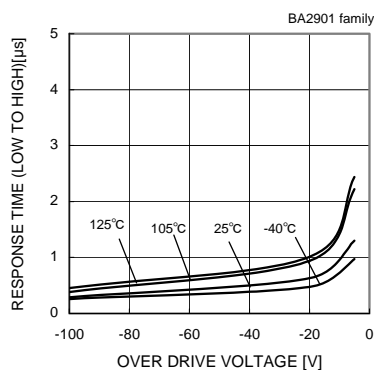

Fig.106  
Response Time (Low to High)  
- Over Drive Voltage  
(VCC=5[V],VRL=5[V],RL=5.1[kΩ])

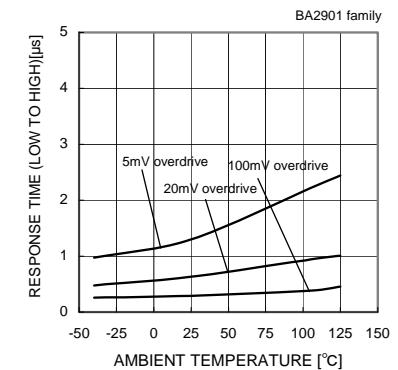

Fig.107  
Response Time (Low to High)  
- Ambient Temperature  
(VCC=5[V],VRL=5[V],RL=5.1[kΩ])

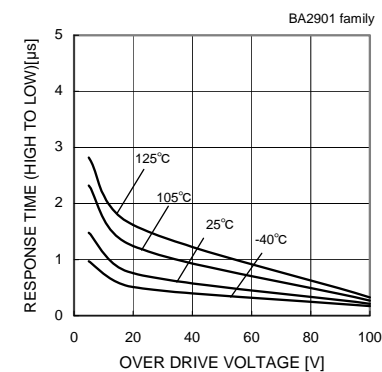

Fig.108  
Response Time (High to Low)  
- Over Drive Voltage  
(VCC=5[V],VRL=5[V],RL=5.1[kΩ])

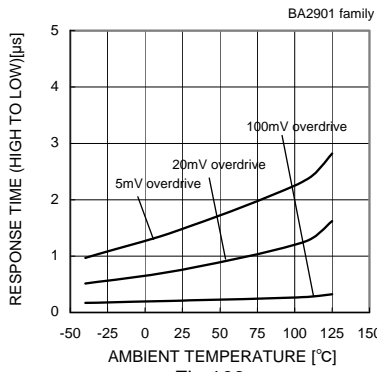

Fig.109  
Response Time (High to Low)  
- Ambient Temperature  
(VCC=5[V],VRL=5[V],RL=5.1[kΩ])

(\*)The data above is ability value of sample, it is not guaranteed. BA2901:-40[°C]~+125[°C] BA2901S:-40[°C]~+105[°C]



●Circuit Diagram

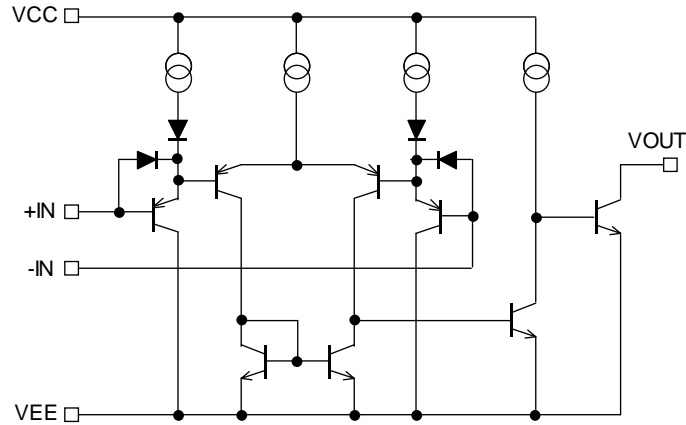

Fig.110 Schematic Diagram (one channel only)

●Test Circuit1 Null Method

VCC, VEE, EK, Vicm Unit : [V], VRL=VCC

Parameter	VF	S1	S2	S3	BA10393 family BA10339 family				BA8391 family BA2903/BA2901 family				Calculation
					VCC	VEE	EK	Vicm	VCC	VEE	EK	Vicm	
					Input Offset Voltage	VF1	ON	ON	ON	5	0	-1.4	
Input Offset Current	VF2	OFF	OFF	ON	5	0	-1.4	0	5	0	-1.4	0	2
Input Bias Current	VF3	OFF	ON	ON	5	0	-1.4	0	5	0	-1.4	0	3
	VF4	ON	OFF		5	0	-1.4	0	5	0	-1.4	0	
Large Signal Voltage Gain	VF5	ON	ON	ON	15	0	-1.4	0	15	0	-1.4	0	4
	VF6				15	0	-11.4	0	15	0	-11.4	0	

- Calculation -

1. Input Offset Voltage (Vio)

$$V_{io} = \frac{|VF1|}{1 + R_f/R_s} \text{ [V]}$$

2. Input Offset Current (Iio)

$$I_{io} = \frac{|VF2 - VF1|}{R_i(1 + R_f / R_s)} \text{ [A]}$$

3. Input Bias Current (Ib)

$$I_b = \frac{|VF4 - VF3|}{2 \times R_i(1 + R_f / R_s)} \text{ [A]}$$

4. Large Signal Voltage Gain (Av)

$$A_v = 20 \times \text{Log} \frac{\Delta EK \times (1 + R_f/R_s)}{|VF5 - VF6|} \text{ [dB]}$$

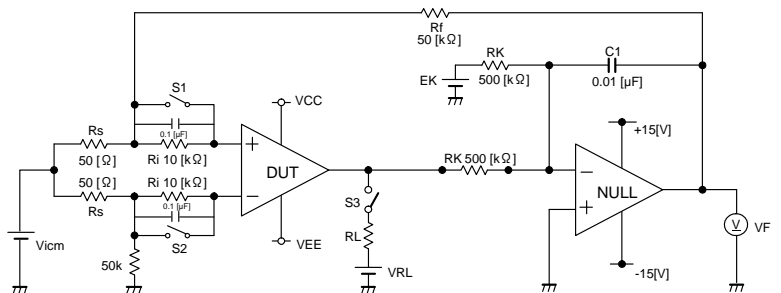

Fig.111 Test circuit1 (one channel only)

● Test Circuit 2: Switch Condition

SW No.		SW 1	SW 2	SW 3	SW 4	SW 5	SW 6	SW 7
Supply Current		OFF	OFF	OFF	OFF	OFF	OFF	OFF
Output Sink Current	VOL=1.5[V]	OFF	ON	ON	OFF	OFF	OFF	ON
Saturation Voltage	IOL=4[mA]	OFF	ON	ON	OFF	ON	ON	OFF
Output Leakage Current	VOH=36[V]	OFF	ON	ON	OFF	OFF	OFF	ON
Response Time	RL=5.1[kΩ], VRL=5[V]	ON	OFF	ON	ON	OFF	OFF	OFF

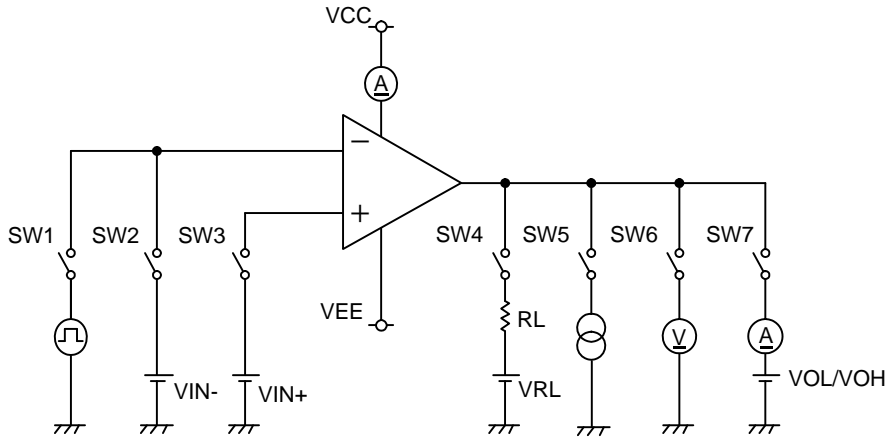

Fig.112 Test Circuit 2 (one channel only)

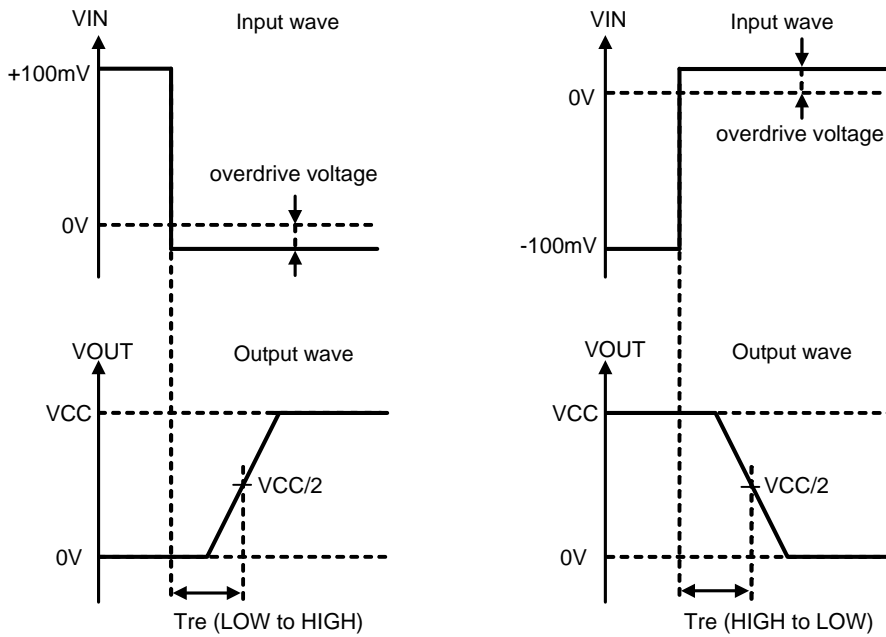

Fig.113 Response Time

**●Description of electrical characteristics**

Described below are descriptions of the relevant electrical terms.

Please note that item names, symbols, and their meanings may differ from those on another manufacturer's documents.

**1. Absolute maximum ratings**

The absolute maximum ratings are values that should never be exceeded, since doing so may result in deterioration of electrical characteristics or damage to the part itself as well as peripheral components.

**1.1 Power supply voltage (VCC/VEE)**

Expresses the maximum voltage that can be supplied between the positive and negative power supply terminals without causing deterioration of the electrical characteristics or destruction of the internal circuitry.

**1.2 Differential input voltage (V<sub>id</sub>)**

Indicates the maximum voltage that can be supplied between the non-inverting and inverting terminals without damaging the IC.

**1.3 Input common-mode voltage range (V<sub>icm</sub>)**

Signifies the maximum voltage that can be supplied to non-inverting and inverting terminals without causing deterioration of the electrical characteristics or damage to the IC itself. Normal operation is not guaranteed within the input common-mode voltage range of the maximum ratings – use within the input common-mode voltage range of the electric characteristics instead.

**1.4 Power dissipation (P<sub>d</sub>)**

Indicates the power that can be consumed by a particular mounted board at ambient temperature (25°C).  
For packaged products, P<sub>d</sub> is determined by maximum junction temperature and the thermal resistance.

**2. Electrical characteristics****2.1 Input offset voltage (V<sub>io</sub>)**

Signifies the voltage difference between the non-inverting and inverting terminals. It can be thought of as the input voltage difference required for setting the output voltage to 0V.

**2.2 Input offset current (I<sub>io</sub>)**

Indicates the difference of the input bias current between the non-inverting and inverting terminals.

**2.3 Input bias current (I<sub>b</sub>)**

Denotes the current that flows into or out of the input terminal, it is defined by the average of the input bias current at the non-inverting terminal and the input bias current at the inverting terminal.

**2.4 Input common-mode voltage range (V<sub>icm</sub>)**

Indicates the input voltage range under which the IC operates normally.

**2.5 Large signal voltage gain (A<sub>V</sub>)**

The amplifying rate (gain) of the output voltage against the voltage difference between the non-inverting and inverting terminals, it is (normally) the amplifying rate (gain) with respect to DC voltage.

$$A_V = (\text{output voltage fluctuation}) / (\text{input offset fluctuation})$$

**2.6 Circuit current (I<sub>CC</sub>)**

Indicates the current of the IC itself that flows under specific conditions and during no-load steady state.

**2.7 Output sink current (I<sub>OL</sub>)**

Denotes the maximum current that can be output under specific output conditions.

**2.8 Output saturation voltage low level output voltage (V<sub>OL</sub>)**

Signifies the voltage range that can be output under specific output conditions.

**2.9 Output leakage current, High level output current (I<sub>Leak</sub>)**

Indicates the current that flows into the IC under specific input and output conditions.

**2.10 Response time (t<sub>re</sub>)**

The interval between the application of input and output conditions.

**2.11 Common-mode rejection ratio (CMRR)**

Denotes the ratio of fluctuation of the input offset voltage when the in-phase input voltage is changed (DC fluctuation).

$$CMRR = (\text{change of input common-mode voltage}) / (\text{input offset fluctuation})$$

**2.12 Power supply rejection ratio (PSRR)**

Signifies the ratio of fluctuation of the input offset voltage when the supply voltage is changed (DC fluctuation).

$$PSRR = (\text{change in power supply voltage}) / (\text{input offset fluctuation})$$

●Derating curves

Power dissipation(total loss) indicates the power that can be consumed by IC at Ta=25°C(normal temperature).IC is heated when it consumed power, and the temperature of IC chip becomes higher than ambient temperature. The temperature that can be accepted by IC chip depends on circuit configuration, manufacturing process, and consumable power is limited. Power dissipation is determined by the temperature allowed in IC chip (maximum junction temperature) and thermal resistance of package (heat dissipation capability). The maximum junction temperature is typically equal to the maximum value in the storage temperature range. Heat generated by consumed power of IC radiates from the mold resin or lead frame of the package. The parameter which indicates this heat dissipation capability(hardness of heat release)is called thermal resistance, represented by the symbol  $\theta_{ja}$  [°C/W].The temperature of IC inside the package can be estimated by this thermal resistance. Fig.114 (a) shows the model of thermal resistance of the package. Thermal resistance  $\theta_{ja}$ , ambient temperature Ta, junction temperature Tj, and power dissipation Pd can be calculated by the equation below:

$$\theta_{ja} = (T_j - T_a) / P_d \quad [^{\circ}\text{C}/\text{W}] \quad \dots \dots \dots (I)$$

Derating curve in Fig.114 (b) indicates power that can be consumed by IC with reference to ambient temperature. Power that can be consumed by IC begins to attenuate at certain ambient temperature. This gradient is determined by thermal resistance  $\theta_{ja}$ . Thermal resistance  $\theta_{ja}$  depends on chip size, power consumption, package, ambient temperature, package condition, wind velocity, etc even when the same of package is used. Thermal reduction curve indicates a reference value measured at a specified condition. Fig.115(c) ~ (f) shows a derating curve for an example of BA8391, BA10393, BA10339, BA2903S, BA2903, BA2901S, and BA2901.

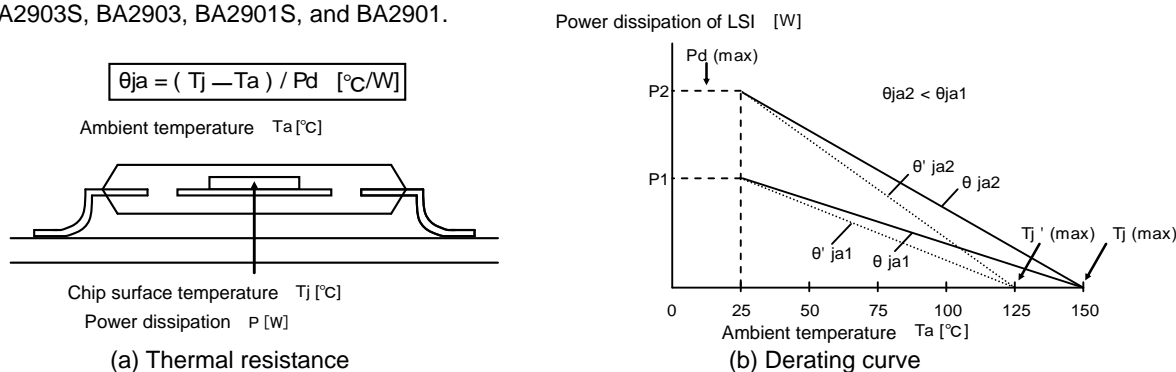
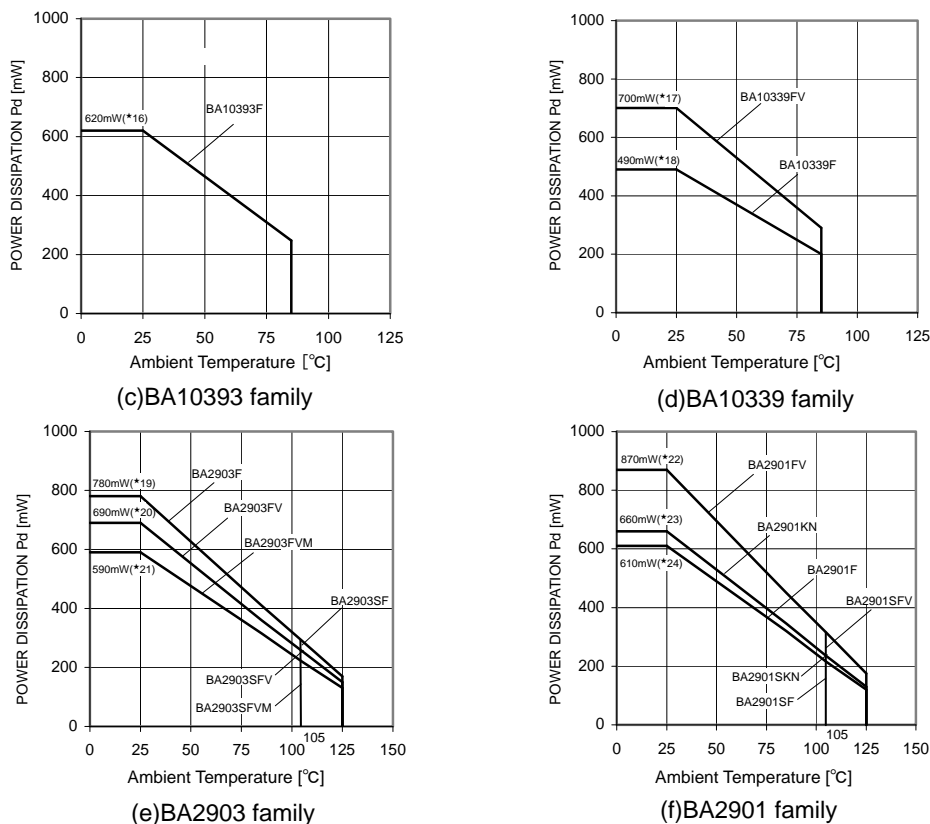

Fig.114 Thermal resistance and derating curve



(*16)	(*17)	(*18)	(*19)	(*20)	(*21)	(*22)	(*23)	(*24)	Unit
6.2	7.0	4.9	6.2	5.5	4.7	7.0	5.3	4.9	[mW/°C]

When using the unit above Ta=25[°C], subtract the value above per degree[°C].  
Permissible dissipation is the value when FR4 glass epoxy board 70[mm] x70[mm] x1.6[mm] (cooper foil area below 3[%]) is mounted.

Fig.115 Derating curve

**●Notes for use**

## 1) Unused circuits

When there are unused circuits it is recommended that they be connected as in Fig.116, setting the non-inverting input terminal to a potential within the in-phase input voltage range (VICR).

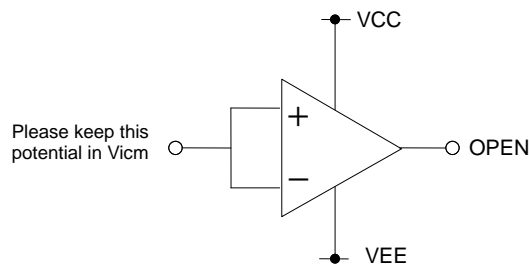

Fig.116 Disable circuit example

## 2) Input terminal voltage

(BA8391 / BA2903 / BA2901 family)Applying VEE + 36V to the input terminal is possible without causing deterioration of the electrical characteristics or destruction, irrespective of the supply voltage. However, this does not ensure normal circuit operation. Please note that the circuit operates normally only when the input voltage is within the common mode input voltage range of the electric characteristics.

## 3) Power supply (signal / dual)

The op-amp operates when the specified voltage supplied is between VCC and VEE. Therefore, the signal supply op-amp can be used as a dual supply op-amp as well.

## 4) Power dissipation Pd

Using the unit in excess of the rated power dissipation may cause deterioration in electrical characteristics due to a rise in chip temperature, including reduced current capability.

Therefore, please take into consideration the power dissipation (Pd) under actual operating conditions and apply a sufficient margin in thermal design. Refer to the thermal derating curves for more information.

## 5) Short-circuit between pins and erroneous mounting

Incorrect mounting may damage the IC. In addition, the presence of foreign particles between the outputs, the output and the power supply, or the output and GND may result in IC destruction.

## 6) Terminal short-circuits

When the output and VCC terminals are shorted, excessive output current may flow, resulting in undue heat generation and, subsequently, destruction.

## 7) Operation in a strong electromagnetic field

Operation in a strong electromagnetic field may cause malfunctions.

## 8) Radiation

This IC is not designed to withstand radiation.

## 9) IC handling

Applying mechanical stress to the IC by deflecting or bending the board may cause fluctuations in the electrical characteristics due to piezoelectric (piezo) effects.

## 10) Board inspection

Connecting a capacitor to a pin with low impedance may stress the IC.

Therefore, discharging the capacitor after every process is recommended. In addition, when attaching and detaching the jig during the inspection phase, ensure that the power is turned off before inspection and removal.

Furthermore, please take measures against ESD in the assembly process as well as during transportation and storage.

●Example of circuit

○Reference voltage is  $V_{in-}$

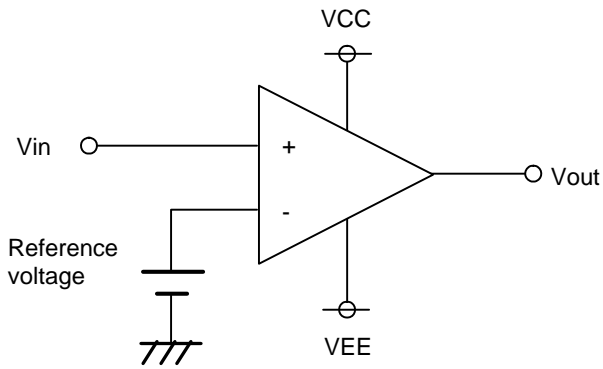

While input voltage is bigger than reference voltage, output voltage is high. While input voltage is smaller than reference voltage, output voltage is low.

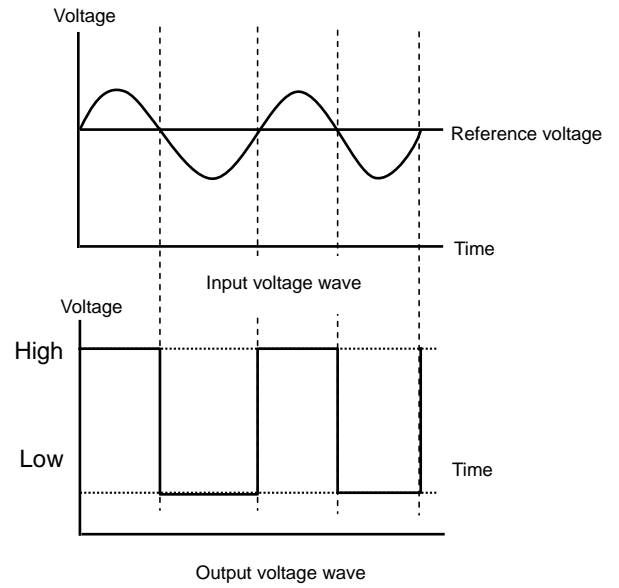

○Reference voltage is  $V_{in+}$

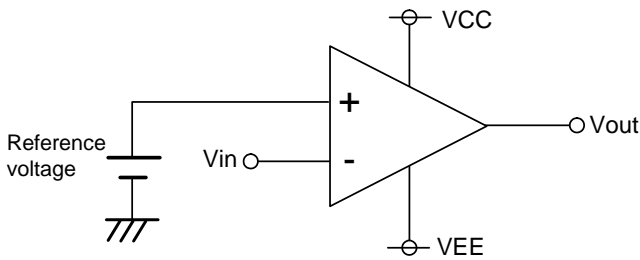

While input voltage is smaller than reference voltage, output voltage is high. While input voltage is bigger than reference voltage, output voltage is low.

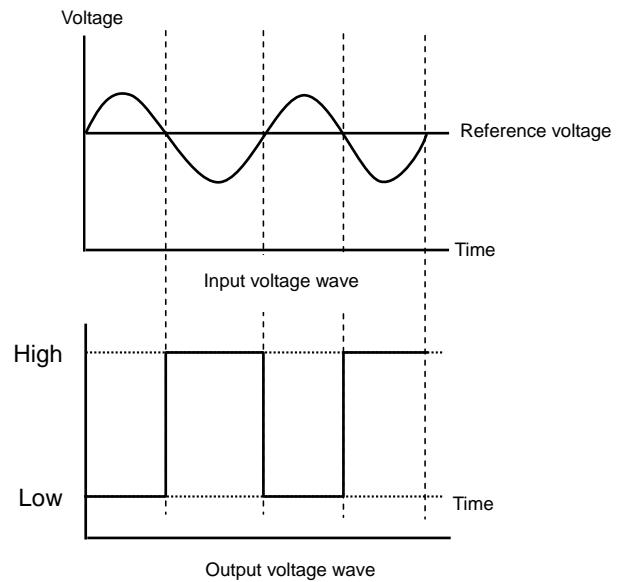

●Ordering part number

B	A
---	---

Part No.

2	9	0	3
---	---	---	---

Part No.  
10393, 10339  
2903S, 2903  
2901S, 2901  
8391

F	V
---	---

Package  
G : SSOP5  
F : SOP8  
SOP14  
FV : SSOP-B8  
SSOP-B14  
FVM : MSOP8  
KN : VQFN16

E	2
---	---

Packaging and forming specification  
E2: Embossed tape and reel  
(SOP8/SOP14/SSOP-B8/SSOP-B14/VQFN16)  
TR: Embossed tape and reel  
(SSOP5/MSOP8)

SSOP5

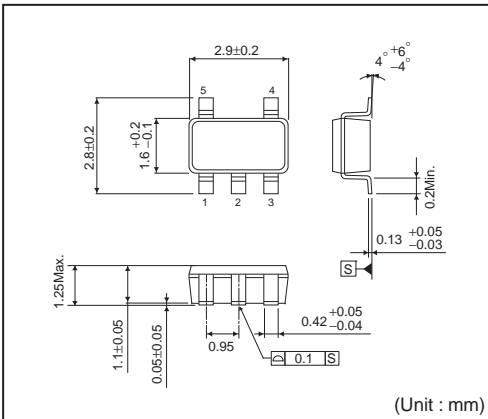

<Tape and Reel information>

Tape	Embossed carrier tape
Quantity	3000pcs
Direction of feed	TR ( The direction is the 1pin of product is at the upper right when you hold reel on the left hand and you pull out the tape on the right hand )

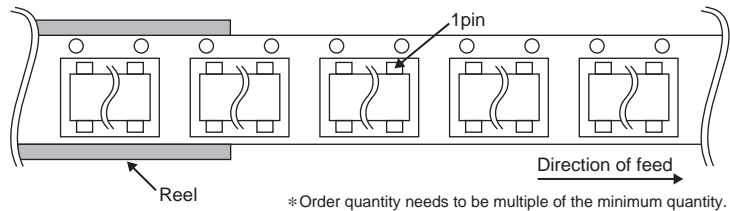

SOP8

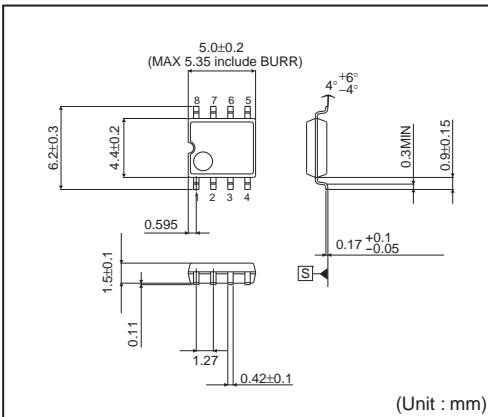

<Tape and Reel information>

Tape	Embossed carrier tape
Quantity	2500pcs
Direction of feed	E2 ( The direction is the 1pin of product is at the upper left when you hold reel on the left hand and you pull out the tape on the right hand )

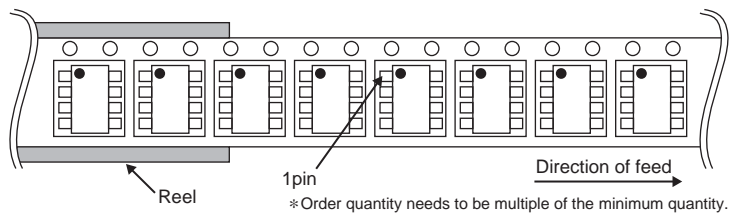



**SOP14**

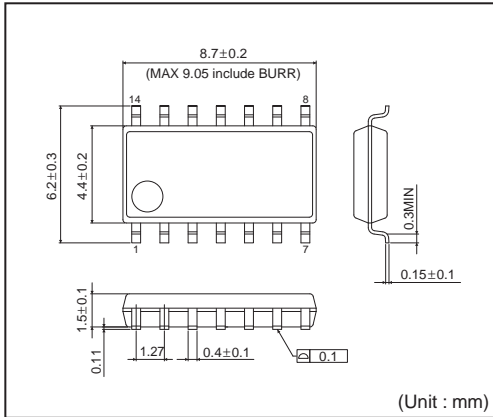

<Tape and Reel information>

Tape	Embossed carrier tape
Quantity	2500pcs
Direction of feed	E2 ( The direction is the 1pin of product is at the upper left when you hold reel on the left hand and you pull out the tape on the right hand )

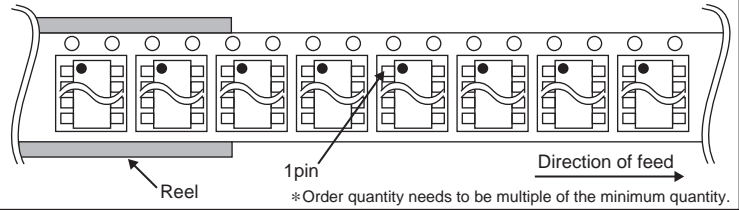

**SSOP-B8**

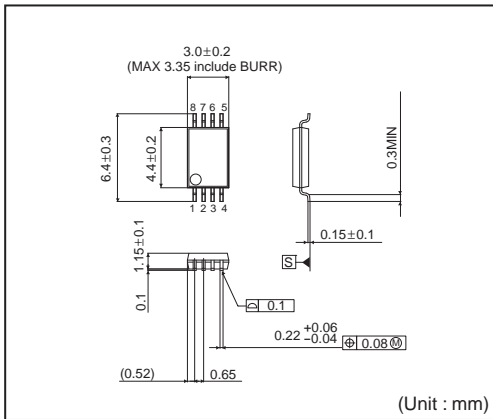

<Tape and Reel information>

Tape	Embossed carrier tape
Quantity	2500pcs
Direction of feed	E2 ( The direction is the 1pin of product is at the upper left when you hold reel on the left hand and you pull out the tape on the right hand )

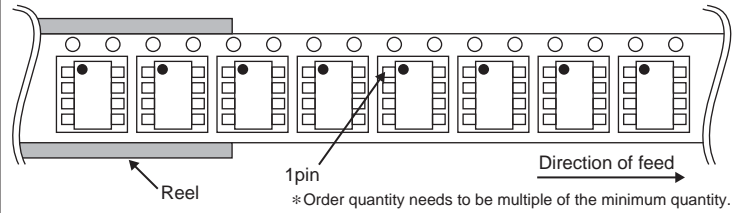

**SSOP-B14**

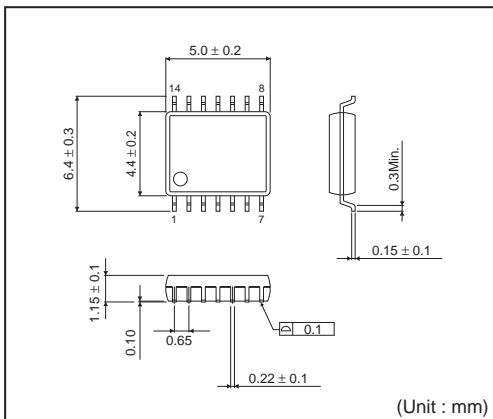

<Tape and Reel information>

Tape	Embossed carrier tape
Quantity	2500pcs
Direction of feed	E2 ( The direction is the 1pin of product is at the upper left when you hold reel on the left hand and you pull out the tape on the right hand )

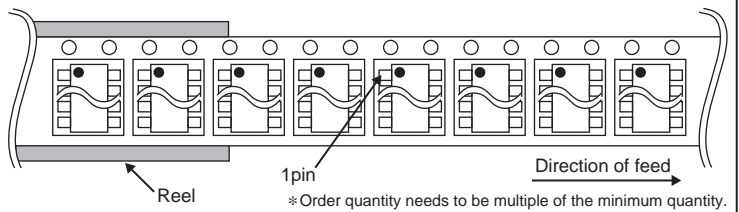

**MSOP8**

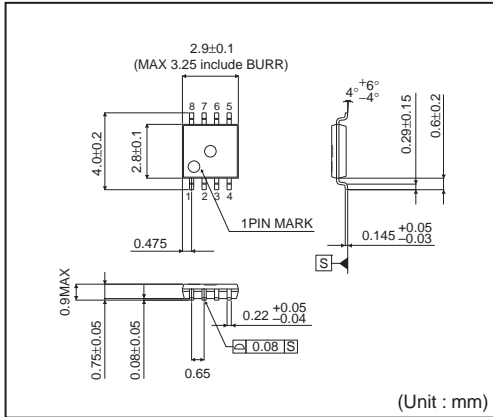

<Tape and Reel information>

Tape	Embossed carrier tape
Quantity	3000pcs
Direction of feed	TR ( The direction is the 1 pin of product is at the upper right when you hold reel on the left hand and you pull out the tape on the right hand )

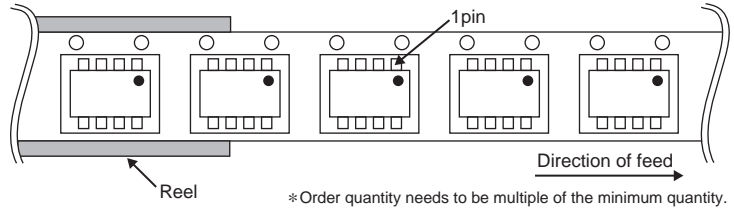

**VQFN16**

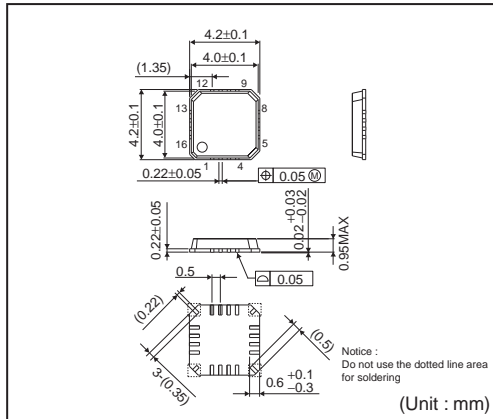

<Tape and Reel information>

Tape	Embossed carrier tape (with dry pack)
Quantity	2500pcs
Direction of feed	E2 ( The direction is the 1 pin of product is at the upper left when you hold reel on the left hand and you pull out the tape on the right hand )

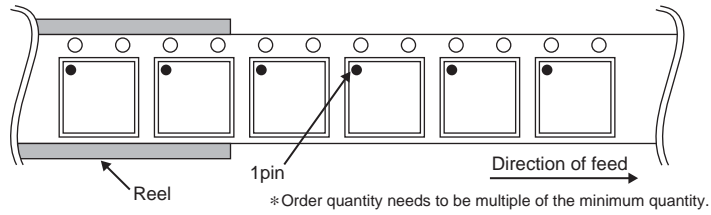

## Notes

No copying or reproduction of this document, in part or in whole, is permitted without the consent of ROHM Co.,Ltd.

The content specified herein is subject to change for improvement without notice.

The content specified herein is for the purpose of introducing ROHM's products (hereinafter "Products"). If you wish to use any such Product, please be sure to refer to the specifications, which can be obtained from ROHM upon request.

Examples of application circuits, circuit constants and any other information contained herein illustrate the standard usage and operations of the Products. The peripheral conditions must be taken into account when designing circuits for mass production.

Great care was taken in ensuring the accuracy of the information specified in this document. However, should you incur any damage arising from any inaccuracy or misprint of such information, ROHM shall bear no responsibility for such damage.

The technical information specified herein is intended only to show the typical functions of and examples of application circuits for the Products. ROHM does not grant you, explicitly or implicitly, any license to use or exercise intellectual property or other rights held by ROHM and other parties. ROHM shall bear no responsibility whatsoever for any dispute arising from the use of such technical information.

The Products specified in this document are intended to be used with general-use electronic equipment or devices (such as audio visual equipment, office-automation equipment, communication devices, electronic appliances and amusement devices).

The Products specified in this document are not designed to be radiation tolerant.

While ROHM always makes efforts to enhance the quality and reliability of its Products, a Product may fail or malfunction for a variety of reasons.

Please be sure to implement in your equipment using the Products safety measures to guard against the possibility of physical injury, fire or any other damage caused in the event of the failure of any Product, such as derating, redundancy, fire control and fail-safe designs. ROHM shall bear no responsibility whatsoever for your use of any Product outside of the prescribed scope or not in accordance with the instruction manual.

The Products are not designed or manufactured to be used with any equipment, device or system which requires an extremely high level of reliability the failure or malfunction of which may result in a direct threat to human life or create a risk of human injury (such as a medical instrument, transportation equipment, aerospace machinery, nuclear-reactor controller, fuel-controller or other safety device). ROHM shall bear no responsibility in any way for use of any of the Products for the above special purposes. If a Product is intended to be used for any such special purpose, please contact a ROHM sales representative before purchasing.

If you intend to export or ship overseas any Product or technology specified herein that may be controlled under the Foreign Exchange and the Foreign Trade Law, you will be required to obtain a license or permit under the Law.



Thank you for your accessing to ROHM product informations.  
More detail product informations and catalogs are available, please contact us.

### ROHM Customer Support System

<http://www.rohm.com/contact/>