



## General Description

The AP2125 series are 300mA, positive voltage regulator ICs fabricated by CMOS process.

Each of these ICs is equipped with a voltage reference, an error amplifier, a resistor network for setting output voltage, a chip enable circuit, a current limit circuit and OTSD (over temperature shut down) circuit to prevent the IC from over current and over temperature.

The AP2125 series have features of high ripple rejection, low dropout voltage, low noise, high output voltage accuracy and low current consumption which make them ideal for use in various battery-powered apparatus.

The AP2125 have 1.8V, 2.5V, 2.8V, 3.0V, 3.3V, 4.15V and 4.2V fixed voltage versions.

These ICs are available in tiny SC-70-5 and SC-82 packages as well as industry standard SOT-23-3 and SOT-23-5 packages.

## Features

- Excellent Ripple Rejection: 70dB Typical (1.8V Version)
- Low Dropout Voltage: 65mV ( $I_{OUT}=100mA$ , 3.3V Version)
- Low Standby Current: 0.01 $\mu A$  Typical
- Low Quiescent Current: 60 $\mu A$  Typical
- Extremely Low Noise: 50 $\mu V_{rms}$  Typical
- Maximum Output Current: 300mA (Min.)
- High Output Voltage Accuracy:  $\pm 2\%$
- Compatible with Low ESR Ceramic Capacitor
- Excellent Line/Load Regulation

## Applications

- CDMA/GSM Cellular Handsets
- Battery-powered Equipments
- Laptops, Palmtops, Notebook Computers
- Hand-held Instruments
- PCMCIA Cards
- Portable Information Appliances

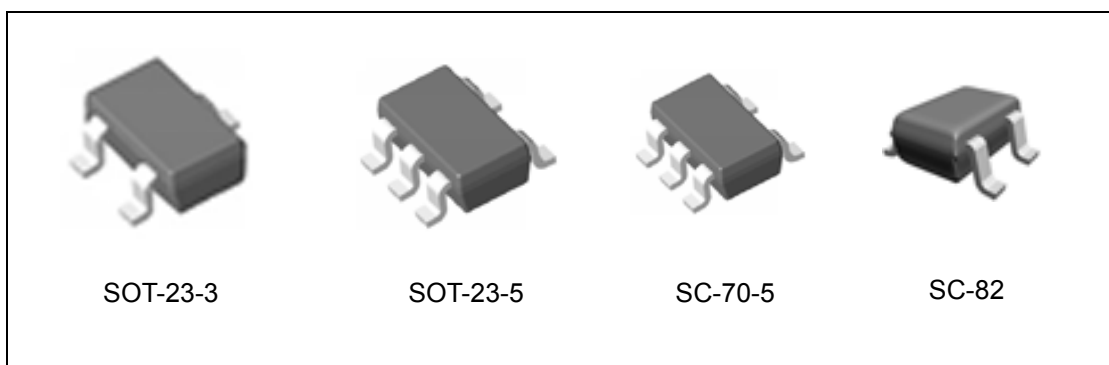

Figure 1. Package Types of AP2125

## Pin Configuration

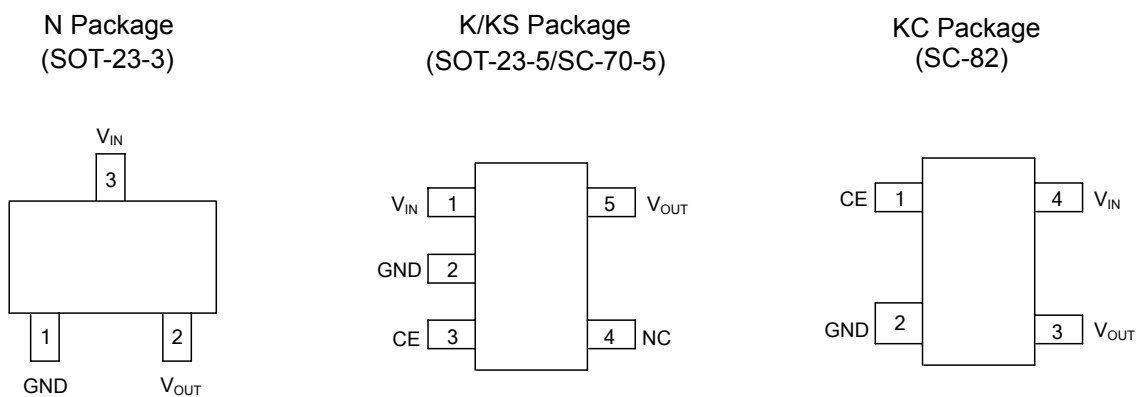
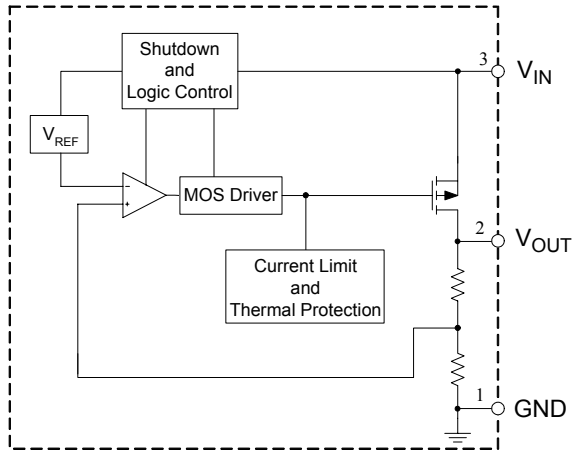

Figure 2. Pin Configuration of AP2125 (Top View)

## Pin Description

Pin Number			Pin Name	Function
SOT-23-3	SOT-23-5/ SC-70-5	SC-82		
3	1	4	$V_{IN}$	Input voltage
1	2	2	GND	Ground
	3	1	CE	Active high enable input pin. Logic high=enable, logic low=shutdown
	4		NC	No connection
2	5	3	$V_{OUT}$	Regulated output voltage

**Functional Block Diagram**



SOT-23-3

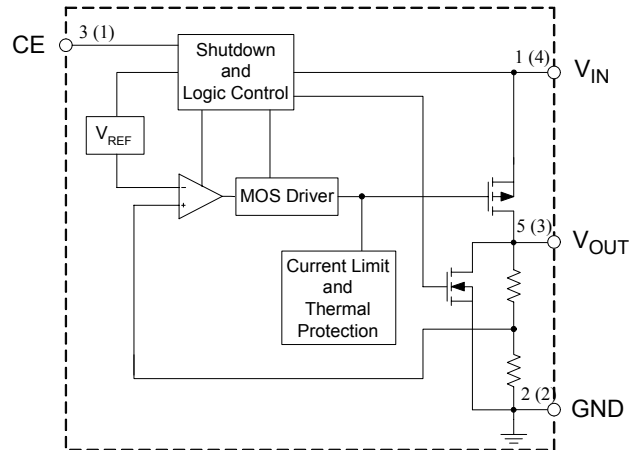

A(B)

A SOT-23-5/SC-70-5

B SC-82

Figure 3. Functional Block Diagram of AP2125



**300mA HIGH SPEED, EXTREMELY LOW NOISE CMOS LDO REGULATOR AP2125**

**Ordering Information**

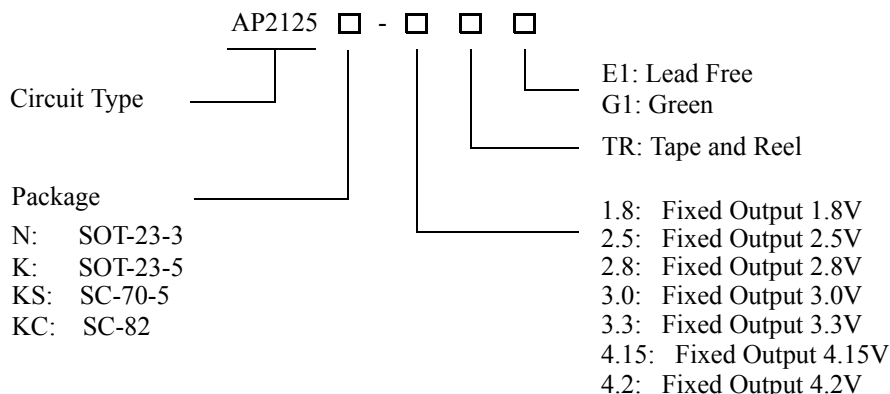

Package	Temperature Range	Part Number		Marking ID		Packing Type
		Lead Free	Green	Lead Free	Green	
SOT-23-3	-40 to 85°C	AP2125N-1.8TRE1	AP2125N-1.8TRG1	EJ2	GJ2	Tape & Reel
		AP2125N-2.5TRE1	AP2125N-2.5TRG1	EJ4	GJ4	Tape & Reel
		AP2125N-2.8TRE1	AP2125N-2.8TRG1	EJ5	GJ5	Tape & Reel
		AP2125N-3.0TRE1	AP2125N-3.0TRG1	EJ6	GJ6	Tape & Reel
		AP2125N-3.3TRE1	AP2125N-3.3TRG1	EJ7	GJ7	Tape & Reel
		AP2125N-4.2TRE1	AP2125N-4.2TRG1	EJ3	GJ3	Tape & Reel
SOT-23-5	-40 to 85°C	AP2125K-1.8TRE1	AP2125K-1.8TRG1	ECB	GCB	Tape & Reel
		AP2125K-2.5TRE1	AP2125K-2.5TRG1	ECD	GCD	Tape & Reel
		AP2125K-2.8TRE1	AP2125K-2.8TRG1	ECE	GCE	Tape & Reel
		AP2125K-3.0TRE1	AP2125K-3.0TRG1	ECF	GCF	Tape & Reel
		AP2125K-3.3TRE1	AP2125K-3.3TRG1	ECG	GCG	Tape & Reel
			AP2125K-4.15TRG1		G CJ	Tape & Reel
SC-70-5	-40 to 85°C	AP2125KS-1.8TRE1	AP2125KS-1.8TRG1	26	B6	Tape & Reel
		AP2125KS-2.5TRE1	AP2125KS-2.5TRG1	35	C5	Tape & Reel
		AP2125KS-2.8TRE1	AP2125KS-2.8TRG1	27	B7	Tape & Reel
		AP2125KS-3.0TRE1	AP2125KS-3.0TRG1	36	C6	Tape & Reel
		AP2125KS-3.3TRE1	AP2125KS-3.3TRG1	28	B8	Tape & Reel
		AP2125KS-4.2TRE1	AP2125KS-4.2TRG1	34	C4	Tape & Reel
SC-82	-40 to 85°C	AP2125KC-1.8TRE1	AP2125KC-1.8TRG1	91	T1	Tape & Reel
		AP2125KC-2.5TRE1	AP2125KC-2.5TRG1	96	T6	Tape & Reel
		AP2125KC-2.8TRE1	AP2125KC-2.8TRG1	92	T2	Tape & Reel
		AP2125KC-3.0TRE1	AP2125KC-3.0TRG1	97	T7	Tape & Reel
		AP2125KC-3.3TRE1	AP2125KC-3.3TRG1	93	T3	Tape & Reel
		AP2125KC-4.2TRE1	AP2125KC-4.2TRG1	95	T5	Tape & Reel

BCD Semiconductor's Pb-free products, as designated with "E1" suffix in the part number, are RoHS compliant. Products with "G1" suffix are available in green packages.

**300mA HIGH SPEED, EXTREMELY LOW NOISE CMOS LDO REGULATOR AP2125****Absolute Maximum Ratings (Note 1)**

Parameter	Symbol	Value	Unit	
Input Voltage	$V_{IN}$	6.5	V	
Enable Input Voltage	$V_{CE}$	-0.3 to $V_{IN}+0.3$	V	
Output Current	$I_{OUT}$	450	mA	
Junction Temperature	$T_J$	150	°C	
Storage Temperature Range	$T_{STG}$	-65 to 150	°C	
Lead Temperature (Soldering, 10sec)	$T_{LEAD}$	260	°C	
Thermal Resistance	$\theta_{JA}$	SOT-23-3	200	°C/W
		SOT-23-5	200	
		SC-70-5	300	
		SC-82	300	
ESD (Human Body Model)	ESD	6000	V	
ESD (Machine Model)	ESD	400	V	

Note 1: Stresses greater than those listed under "Absolute Maximum Ratings" may cause permanent damage to the device. These are stress ratings only, and functional operation of the device at these or any other conditions beyond those indicated under "Recommended Operating Conditions" is not implied. Exposure to "Absolute Maximum Ratings" for extended periods may affect device reliability.

**Recommended Operating Conditions**

Parameter	Symbol	Min	Max	Unit
Input Voltage	$V_{IN}$	$V_{OUT}+0.5V$	6	V
Operating Ambient Temperature Range	$T_A$	-40	85	°C



**300mA HIGH SPEED, EXTREMELY LOW NOISE CMOS LDO REGULATOR AP2125**

**Electrical Characteristics**

**AP2125-1.8 Electrical Characteristics**

( $V_{IN}=2.8V$ ,  $T_A=25^{\circ}C$ ,  $C_{IN}=1\mu F$ ,  $C_{OUT}=1\mu F$ , **Bold** typeface applies over  $-40^{\circ}C \leq T_J \leq 85^{\circ}C$ , unless otherwise specified.)

Parameter	Symbol	Conditions	Min	Typ	Max	Unit	
Output Voltage	$V_{OUT}$	$V_{IN}=2.8V$ $1mA \leq I_{OUT} \leq 30mA$	1.764	1.8	1.836	V	
Input Voltage	$V_{IN}$				6	V	
Maximum Output Current	$I_{OUT(MAX)}$	$V_{IN}-V_{OUT}=1V$ , $V_{OUT}=1.76V$	300	360		mA	
Load Regulation	$V_{RLOAD}$	$V_{IN}=2.8V$ $1mA \leq I_{OUT} \leq 300mA$		6		mV	
Line Regulation	$V_{RLINE}$	$2.8V \leq V_{IN} \leq 6V$ $I_{OUT}=30mA$		1		mV	
Dropout Voltage	$V_{DROP}$	$I_{OUT}=10mA$		10	12	mV	
		$I_{OUT}=100mA$		100	120		
		$I_{OUT}=300mA$		300	360		
Quiescent Current	$I_Q$	$V_{IN}=2.8V$ , $I_{OUT}=0mA$		60	90	$\mu A$	
Standby Current	$I_{STD}$	$V_{IN}=2.8V$ $V_{CE}$ in OFF mode		0.01	1.0	$\mu A$	
Power Supply Rejection Ratio	PSRR	Ripple 0.5Vp-p $V_{IN}=2.8V$	$f=100Hz$		70		dB
			$f=1KHz$		70		dB
Output Voltage Temperature Coefficient	$(\Delta V_{OUT}/V_{OUT})/\Delta T$	$I_{OUT}=30mA$		<b><math>\pm 100</math></b>		ppm/ $^{\circ}C$	
Short Current Limit	$I_{SHORT}$	$V_{OUT}=0V$		50		mA	
RMS Output Noise	$V_{NOISE}$	$10Hz \leq f \leq 100kHz$		50		$\mu V_{rms}$	
CE "High" Voltage		CE input voltage "High"	1.5			V	
CE "Low" Voltage		CE input voltage "Low"			0.4	V	
Thermal Shutdown				160		$^{\circ}C$	
Thermal Shutdown Hysteresis				25		$^{\circ}C$	



**300mA HIGH SPEED, EXTREMELY LOW NOISE CMOS LDO REGULATOR AP2125**

**Electrical Characteristics (Continued)**

**AP2125-2.5 Electrical Characteristics**

( $V_{IN}=3.5V$ ,  $T_A=25^{\circ}C$ ,  $C_{IN}=1\mu F$ ,  $C_{OUT}=1\mu F$ , **Bold** typeface applies over  $-40^{\circ}C \leq T_J \leq 85^{\circ}C$ , unless otherwise specified.)

Parameter	Symbol	Conditions	Min	Typ	Max	Unit	
Output Voltage	$V_{OUT}$	$V_{IN}=3.5V$ $1mA \leq I_{OUT} \leq 30mA$	2.45	2.5	2.55	V	
Input Voltage	$V_{IN}$				6	V	
Maximum Output Current	$I_{OUT(MAX)}$	$V_{IN}-V_{OUT}=1V$ , $V_{OUT}=2.45V$	300	360		mA	
Load Regulation	$V_{RLOAD}$	$V_{IN}=3.5V$ $1mA \leq I_{OUT} \leq 300mA$		10		mV	
Line Regulation	$V_{RLINE}$	$3.5V \leq V_{IN} \leq 6V$ $I_{OUT}=30mA$		1		mV	
Dropout Voltage	$V_{DROP}$	$I_{OUT}=10mA$		6.5	10	mV	
		$I_{OUT}=100mA$		65	100		
		$I_{OUT}=300mA$		200	300		
Quiescent Current	$I_Q$	$V_{IN}=3.5V$ , $I_{OUT}=0mA$		60	90	$\mu A$	
Standby Current	$I_{STD}$	$V_{IN}=3.5V$ $V_{CE}$ in OFF mode		0.01	1.0	$\mu A$	
Power Supply Rejection Ratio	PSRR	Ripple 0.5Vp-p $V_{IN}=3.5V$	$f=100Hz$		65		dB
			$f=1KHz$		65		dB
Output Voltage Temperature Coefficient	$(\Delta V_{OUT}/V_{OUT})/\Delta T$	$I_{OUT}=30mA$		<b><math>\pm 100</math></b>		ppm/ $^{\circ}C$	
Short Current Limit	$I_{SHORT}$	$V_{OUT}=0V$		50		mA	
RMS Output Noise	$V_{NOISE}$	$10Hz \leq f \leq 100kHz$		50		$\mu V_{rms}$	
CE "High" Voltage		CE input voltage "High"	1.5			V	
CE "Low" Voltage		CE input voltage "Low"			0.4	V	
Thermal Shutdown				160		$^{\circ}C$	
Thermal Shutdown Hysteresis				25		$^{\circ}C$	



**300mA HIGH SPEED, EXTREMELY LOW NOISE CMOS LDO REGULATOR AP2125**

**Electrical Characteristics (Continued)**

**AP2125-2.8 Electrical Characteristics**

( $V_{IN}=3.8V$ ,  $T_A=25^{\circ}C$ ,  $C_{IN}=1\mu F$ ,  $C_{OUT}=1\mu F$ , **Bold** typeface applies over  $-40^{\circ}C \leq T_J \leq 85^{\circ}C$ , unless otherwise specified.)

Parameter	Symbol	Conditions	Min	Typ	Max	Unit	
Output Voltage	$V_{OUT}$	$V_{IN}=3.8V$ $1mA \leq I_{OUT} \leq 30mA$	2.744	2.8	2.856	V	
Input Voltage	$V_{IN}$				6	V	
Maximum Output Current	$I_{OUT(MAX)}$	$V_{IN}-V_{OUT}=1V$ , $V_{OUT}=2.74V$	300	360		mA	
Load Regulation	$V_{RLOAD}$	$V_{IN}=3.8V$ $1mA \leq I_{OUT} \leq 300mA$		11		mV	
Line Regulation	$V_{RLINE}$	$3.8V \leq V_{IN} \leq 6V$ $I_{OUT}=30mA$		1		mV	
Dropout Voltage	$V_{DROP}$	$I_{OUT}=10mA$		6.5	10	mV	
		$I_{OUT}=100mA$		65	100		
		$I_{OUT}=300mA$		200	300		
Quiescent Current	$I_Q$	$V_{IN}=3.8V$ , $I_{OUT}=0mA$		60	90	$\mu A$	
Standby Current	$I_{STD}$	$V_{IN}=3.8V$ $V_{CE}$ in OFF mode		0.01	1.0	$\mu A$	
Power Supply Rejection Ratio	PSRR	Ripple 0.5Vp-p $V_{IN}=3.8V$	$f=100Hz$		65		dB
			$f=1KHz$		65		dB
Output Voltage Temperature Coefficient	$(\Delta V_{OUT}/V_{OUT})/\Delta T$	$I_{OUT}=30mA$		<b><math>\pm 100</math></b>		ppm/ $^{\circ}C$	
Short Current Limit	$I_{SHORT}$	$V_{OUT}=0V$		50		mA	
RMS Output Noise	$V_{NOISE}$	$10Hz \leq f \leq 100kHz$		50		$\mu V_{rms}$	
CE "High" Voltage		CE input voltage "High"	1.5			V	
CE "Low" Voltage		CE input voltage "Low"			0.4	V	
Thermal Shutdown				160		$^{\circ}C$	
Thermal Shutdown Hysteresis				25		$^{\circ}C$	





**300mA HIGH SPEED, EXTREMELY LOW NOISE CMOS LDO REGULATOR AP2125**

**Electrical Characteristics (Continued)**

**AP2125-3.0 Electrical Characteristics**

( $V_{IN}=4.0V$ ,  $T_A=25^{\circ}C$ ,  $C_{IN}=1\mu F$ ,  $C_{OUT}=1\mu F$ , **Bold** typeface applies over  $-40^{\circ}C \leq T_J \leq 85^{\circ}C$ , unless otherwise specified.)

Parameter	Symbol	Conditions	Min	Typ	Max	Unit	
Output Voltage	$V_{OUT}$	$V_{IN}=4.0V$ $1mA \leq I_{OUT} \leq 30mA$	2.94	3.0	3.06	V	
Input Voltage	$V_{IN}$				6	V	
Maximum Output Current	$I_{OUT(MAX)}$	$V_{IN}-V_{OUT}=1V$ , $V_{OUT}=2.94V$	300	360		mA	
Load Regulation	$V_{RLOAD}$	$V_{IN}=4.0V$ $1mA \leq I_{OUT} \leq 300mA$		12		mV	
Line Regulation	$V_{RLINE}$	$4.0V \leq V_{IN} \leq 6V$ $I_{OUT}=30mA$		1		mV	
Dropout Voltage	$V_{DROP}$	$I_{OUT}=10mA$		6.5	10	mV	
		$I_{OUT}=100mA$		65	100		
		$I_{OUT}=300mA$		200	300		
Quiescent Current	$I_Q$	$V_{IN}=4.0V$ , $I_{OUT}=0mA$		60	90	$\mu A$	
Standby Current	$I_{STD}$	$V_{IN}=4.0V$ $V_{CE}$ in OFF mode		0.01	1.0	$\mu A$	
Power Supply Rejection Ratio	PSRR	Ripple 0.5Vp-p $V_{IN}=4.0V$	$f=100Hz$		65		dB
			$f=1KHz$		65		dB
Output Voltage Temperature Coefficient	$(\Delta V_{OUT}/V_{OUT})/\Delta T$	$I_{OUT}=30mA$		<b><math>\pm 100</math></b>		ppm/ $^{\circ}C$	
Short Current Limit	$I_{SHORT}$	$V_{OUT}=0V$		50		mA	
RMS Output Noise	$V_{NOISE}$	$10Hz \leq f \leq 100kHz$		50		$\mu V_{rms}$	
CE "High" Voltage		CE input voltage "High"	1.5			V	
CE "Low" Voltage		CE input voltage "Low"			0.4	V	
Thermal Shutdown				160		$^{\circ}C$	
Thermal Shutdown Hysteresis				25		$^{\circ}C$	



**300mA HIGH SPEED, EXTREMELY LOW NOISE CMOS LDO REGULATOR AP2125**

**Electrical Characteristics (Continued)**

**AP2125-3.3 Electrical Characteristics**

( $V_{IN}=4.3V$ ,  $T_A=25^\circ C$ ,  $C_{IN}=1\mu F$ ,  $C_{OUT}=1\mu F$ , **Bold** typeface applies over  $-40^\circ C \leq T_J \leq 85^\circ C$ , unless otherwise specified.)

Parameter	Symbol	Conditions	Min	Typ	Max	Unit	
Output Voltage	$V_{OUT}$	$V_{IN}=4.3V$ $1mA \leq I_{OUT} \leq 30mA$	3.234	3.3	3.366	V	
Input Voltage	$V_{IN}$				6	V	
Maximum Output Current	$I_{OUT(MAX)}$	$V_{IN}-V_{OUT}=1V$ , $V_{OUT}=3.23V$	300	360		mA	
Load Regulation	$V_{RLOAD}$	$V_{IN}=4.3V$ $1mA \leq I_{OUT} \leq 300mA$		13		mV	
Line Regulation	$V_{RLINE}$	$4.3V \leq V_{IN} \leq 6V$ $I_{OUT}=30mA$		1		mV	
Dropout Voltage	$V_{DROP}$	$I_{OUT}=10mA$		6.5	10	mV	
		$I_{OUT}=100mA$		65	100		
		$I_{OUT}=300mA$		200	300		
Quiescent Current	$I_Q$	$V_{IN}=4.3V$ , $I_{OUT}=0mA$		60	90	$\mu A$	
Standby Current	$I_{STD}$	$V_{IN}=4.3V$ $V_{CE}$ in OFF mode		0.01	1.0	$\mu A$	
Power Supply Rejection Ratio	PSRR	Ripple 0.5Vp-p $V_{IN}=4.3V$	$f=100Hz$		65		dB
			$f=1KHz$		65		dB
Output Voltage Temperature Coefficient	$(\Delta V_{OUT}/V_{OUT})/\Delta T$	$I_{OUT}=30mA$		<b><math>\pm 100</math></b>		ppm/ $^\circ C$	
Short Current Limit	$I_{SHORT}$	$V_{OUT}=0V$		50		mA	
RMS Output Noise	$V_{NOISE}$	$10Hz \leq f \leq 100kHz$		50		$\mu V_{rms}$	
CE "High" Voltage		CE input voltage "High"	1.5			V	
CE "Low" Voltage		CE input voltage "Low"			0.4	V	
Thermal Shutdown				160		$^\circ C$	
Thermal Shutdown Hysteresis				25		$^\circ C$	



**300mA HIGH SPEED, EXTREMELY LOW NOISE CMOS LDO REGULATOR AP2125**

**Electrical Characteristics (Continued)**

**AP2125-4.15 Electrical Characteristics**

( $V_{IN}=5.15V$ ,  $T_A=25^{\circ}C$ ,  $C_{IN}=1\mu F$ ,  $C_{OUT}=1\mu F$ , **Bold** typeface applies over  $-40^{\circ}C \leq T_J \leq 85^{\circ}C$ , unless otherwise specified.)

Parameter	Symbol	Conditions	Min	Typ	Max	Unit
Output Voltage	$V_{OUT}$	$V_{IN}=5.15V$ $1mA \leq I_{OUT} \leq 30mA$	4.067	4.15	4.233	V
Input Voltage	$V_{IN}$				6	V
Maximum Output Current	$I_{OUT(MAX)}$	$V_{IN}-V_{OUT}=1V$ , $V_{OUT}=4.06V$	300	360		mA
Load Regulation	$V_{RLOAD}$	$V_{IN}=5.15V$ $1mA \leq I_{OUT} \leq 300mA$		13		mV
Line Regulation	$V_{RLINE}$	$5.15V \leq V_{IN} \leq 6V$ $I_{OUT}=30mA$		1		mV
Dropout Voltage	$V_{DROP}$	$I_{OUT}=10mA$		6.5	10	mV
		$I_{OUT}=100mA$		65	100	
		$I_{OUT}=300mA$		200	300	
Quiescent Current	$I_Q$	$V_{IN}=5.15V$ , $I_{OUT}=0mA$		60	90	$\mu A$
Standby Current	$I_{STD}$	$V_{IN}=5.15V$ $V_{CE}$ in OFF mode		0.01	1.0	$\mu A$
Power Supply Rejection Ratio	PSRR	Ripple 0.5Vp-p $V_{IN}=5.15V$	$f=100Hz$	65		dB
			$f=1KHz$	65		dB
Output Voltage Temperature Coefficient	$(\Delta V_{OUT}/V_{OUT})/\Delta T$	$I_{OUT}=30mA$		<b><math>\pm 100</math></b>		ppm/ $^{\circ}C$
Short Current Limit	$I_{SHORT}$	$V_{OUT}=0V$		50		mA
RMS Output Noise	$V_{NOISE}$	$10Hz \leq f \leq 100kHz$		50		$\mu V_{rms}$
CE "High" Voltage		CE input voltage "High"	1.5			V
CE "Low" Voltage		CE input voltage "Low"			0.4	V
Thermal Shutdown				160		$^{\circ}C$
Thermal Shutdown Hysteresis				25		$^{\circ}C$



**300mA HIGH SPEED, EXTREMELY LOW NOISE CMOS LDO REGULATOR AP2125**

**Electrical Characteristics (Continued)**

**AP2125-4.2 Electrical Characteristics**

( $V_{IN}=5.2V$ ,  $T_A=25^{\circ}C$ ,  $C_{IN}=1\mu F$ ,  $C_{OUT}=1\mu F$ , **Bold** typeface applies over  $-40^{\circ}C \leq T_J \leq 85^{\circ}C$ , unless otherwise specified.)

Parameter	Symbol	Conditions	Min	Typ	Max	Unit	
Output Voltage	$V_{OUT}$	$V_{IN}=5.2V$ $1mA \leq I_{OUT} \leq 30mA$	4.116	4.2	4.284	V	
Input Voltage	$V_{IN}$				6	V	
Maximum Output Current	$I_{OUT(MAX)}$	$V_{IN}-V_{OUT}=1V$ , $V_{OUT}=4.12V$	300	360		mA	
Load Regulation	$V_{RLOAD}$	$V_{IN}=5.2V$ $1mA \leq I_{OUT} \leq 300mA$		13		mV	
Line Regulation	$V_{RLINE}$	$5.2V \leq V_{IN} \leq 6V$ $I_{OUT}=30mA$		1		mV	
Dropout Voltage	$V_{DROP}$	$I_{OUT}=10mA$		6.5	10	mV	
		$I_{OUT}=100mA$		65	100		
		$I_{OUT}=300mA$		200	300		
Quiescent Current	$I_Q$	$V_{IN}=5.2V$ , $I_{OUT}=0mA$		60	90	$\mu A$	
Standby Current	$I_{STD}$	$V_{IN}=5.2V$ $V_{CE}$ in OFF mode		0.01	1.0	$\mu A$	
Power Supply Rejection Ratio	PSRR	Ripple 0.5Vp-p $V_{IN}=5.2V$	$f=100Hz$		65		dB
			$f=1KHz$		65		dB
Output Voltage Temperature Coefficient	$(\Delta V_{OUT}/V_{OUT})/\Delta T$	$I_{OUT}=30mA$		<b><math>\pm 100</math></b>		ppm/ $^{\circ}C$	
Short Current Limit	$I_{SHORT}$	$V_{OUT}=0V$		50		mA	
RMS Output Noise	$V_{NOISE}$	$10Hz \leq f \leq 100kHz$		50		$\mu V_{rms}$	
CE "High" Voltage		CE input voltage "High"	1.5			V	
CE "Low" Voltage		CE input voltage "Low"			0.4	V	
Thermal Shutdown				160		$^{\circ}C$	
Thermal Shutdown Hysteresis				25		$^{\circ}C$	



**300mA HIGH SPEED, EXTREMELY LOW NOISE CMOS LDO REGULATOR AP2125**

**Typical Performance Characteristics**

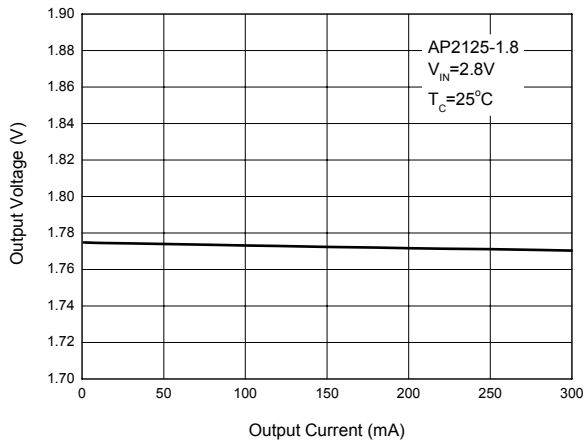

Figure 4. Output Voltage vs. Output Current

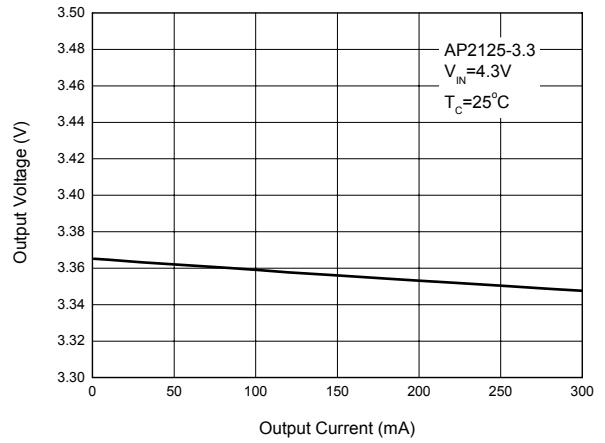

Figure 5. Output Voltage vs. Output Current

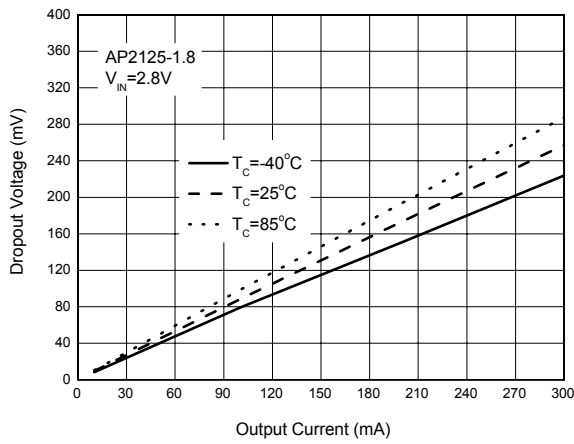

Figure 6. Dropout Voltage vs. Output Current

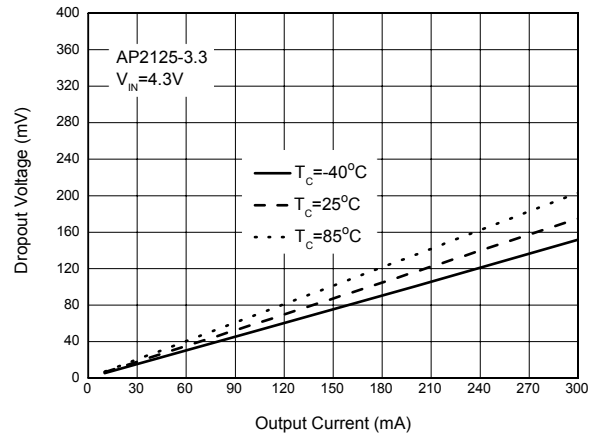

Figure 7. Dropout Voltage vs. Output Current



**300mA HIGH SPEED, EXTREMELY LOW NOISE CMOS LDO REGULATOR AP2125**

**Typical Performance Characteristics (Continued)**

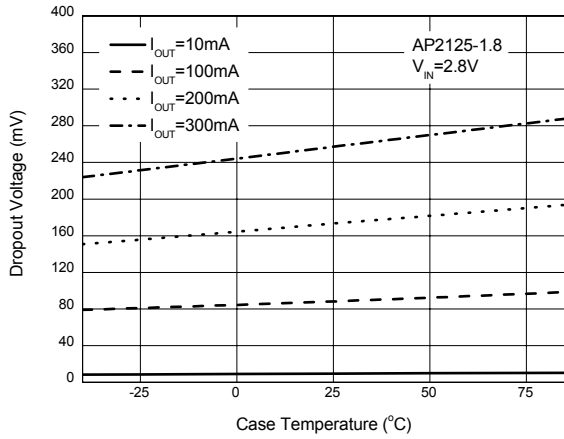

Figure 8. Dropout Voltage vs. Case Temperature

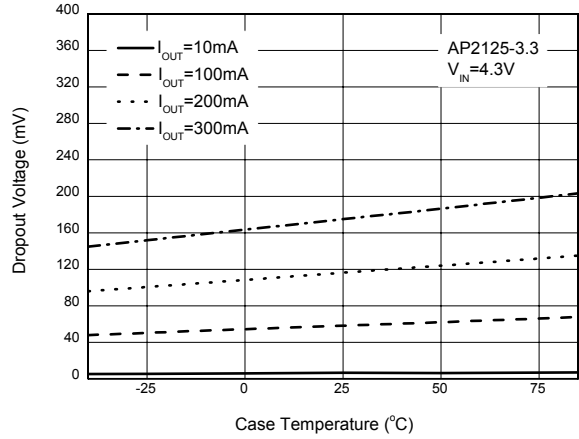

Figure 9. Dropout Voltage vs. Case Temperature

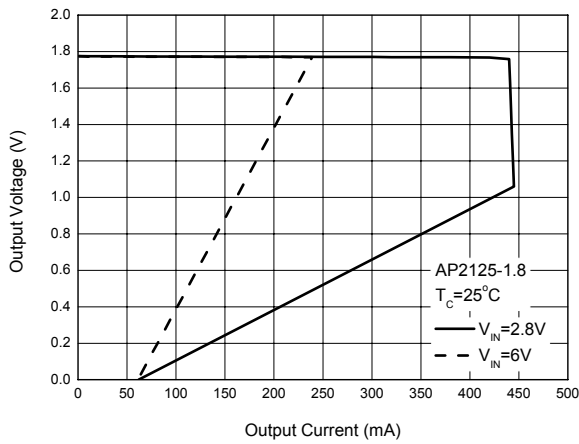

Figure 10. Current Limit

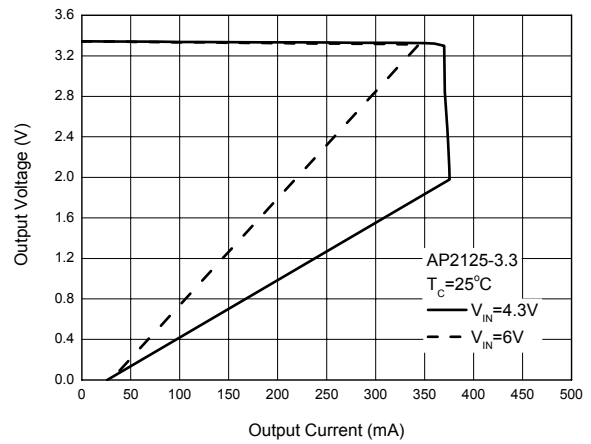

Figure 11. Current Limit



**300mA HIGH SPEED, EXTREMELY LOW NOISE CMOS LDO REGULATOR AP2125**

**Typical Performance Characteristics (Continued)**

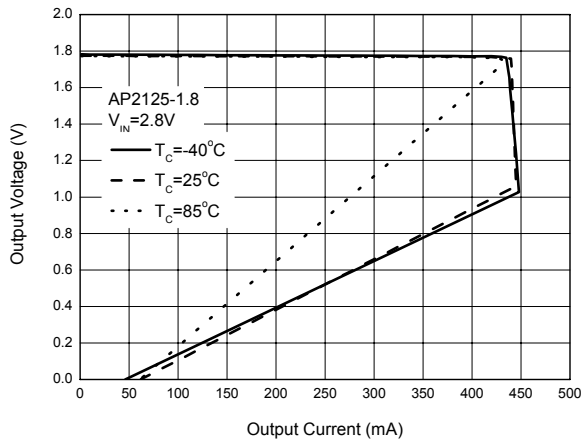

Figure 12. Current Limit

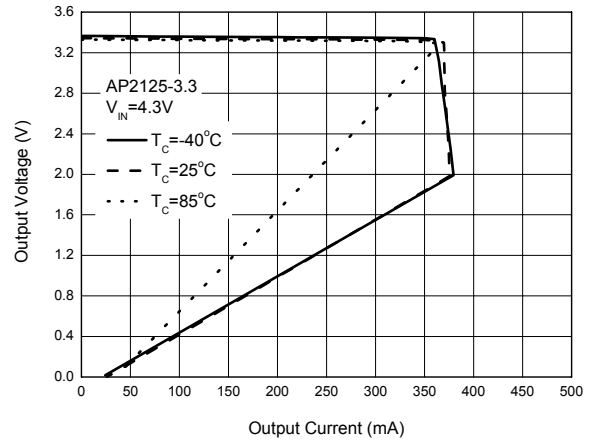

Figure 13. Current Limit

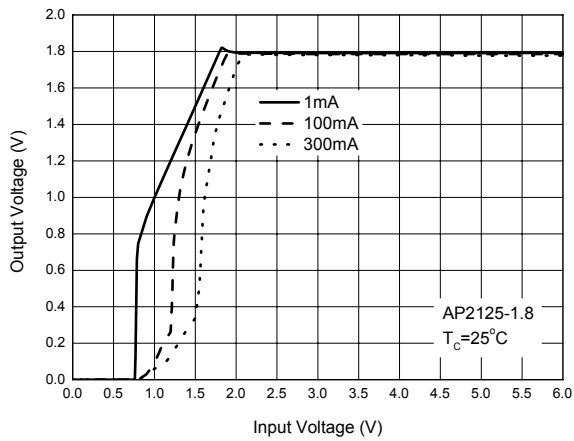

Figure 14. Output Voltage vs. Input Voltage

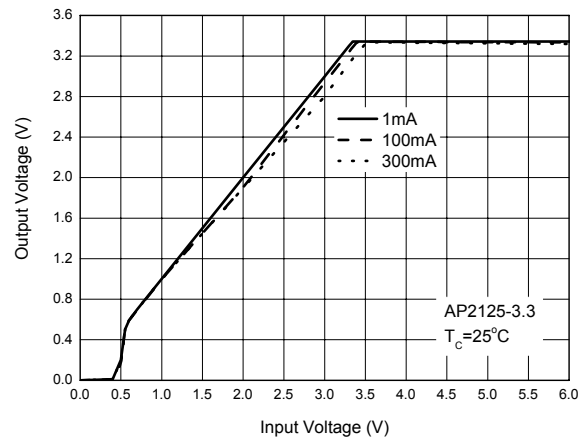

Figure 15. Output Voltage vs. Input Voltage



**300mA HIGH SPEED, EXTREMELY LOW NOISE CMOS LDO REGULATOR AP2125**

**Typical Performance Characteristics (Continued)**

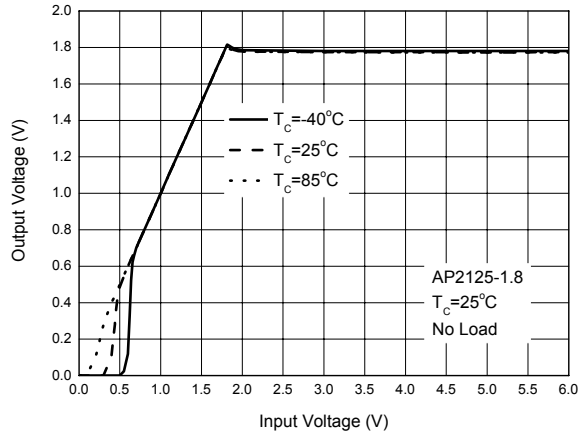

Figure 16. Output Voltage vs. Input Voltage

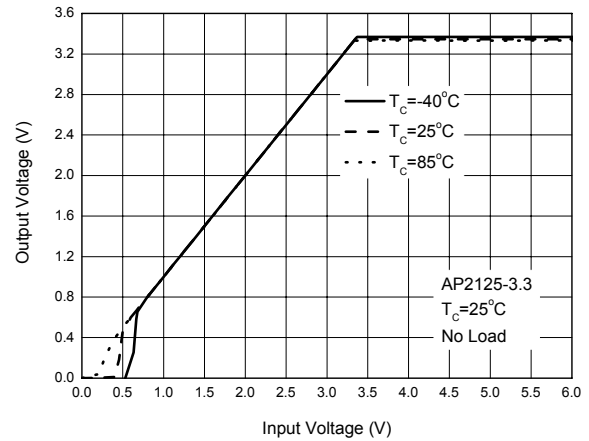

Figure 17. Output Voltage vs. Input Voltage

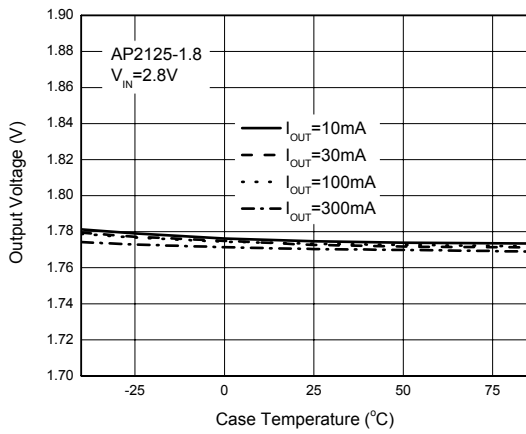

Figure 18. Output Voltage vs. Case Temperature

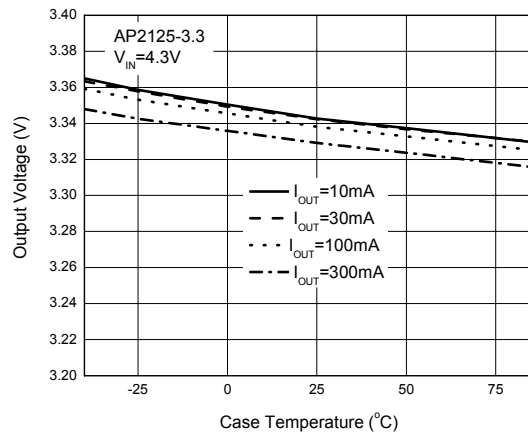

Figure 19. Output Voltage vs. Case Temperature





**300mA HIGH SPEED, EXTREMELY LOW NOISE CMOS LDO REGULATOR AP2125**

**Typical Performance Characteristics (Continued)**

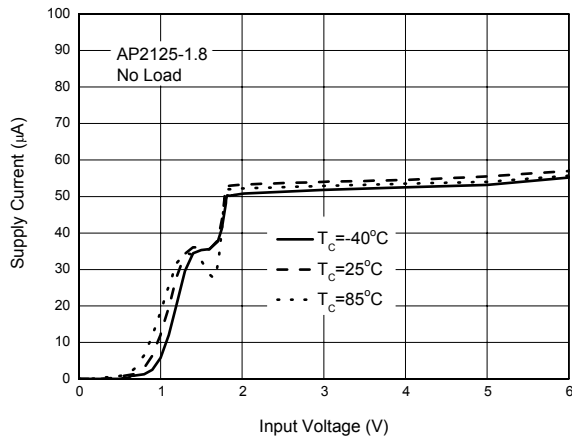

Figure 20. Supply Current vs. Input Voltage

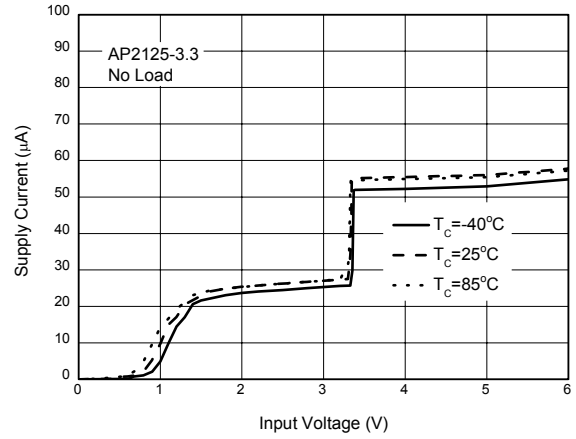

Figure 21. Supply Current vs. Input Voltage

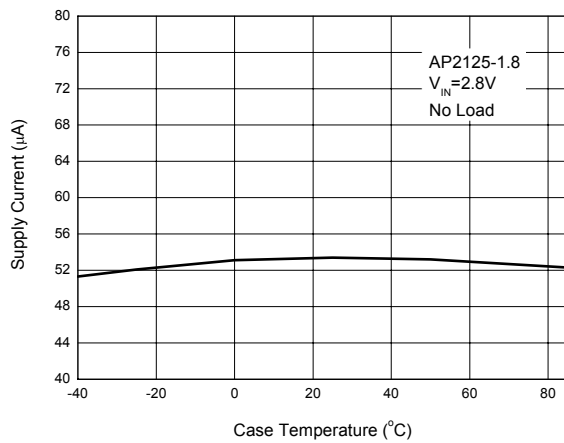

Figure 22. Supply Current vs. Case Temperature

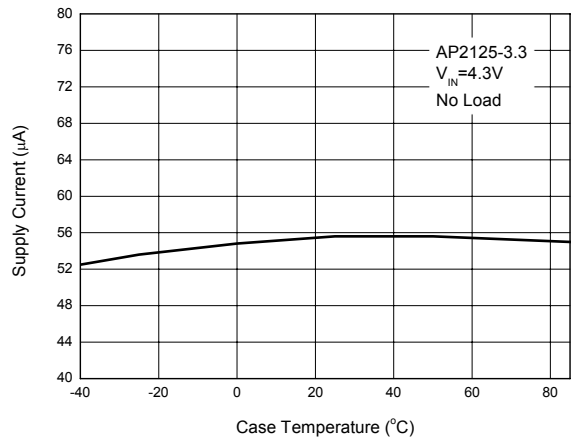

Figure 23. Supply Current vs. Case Temperature



**300mA HIGH SPEED, EXTREMELY LOW NOISE CMOS LDO REGULATOR AP2125**

**Typical Performance Characteristics (Continued)**

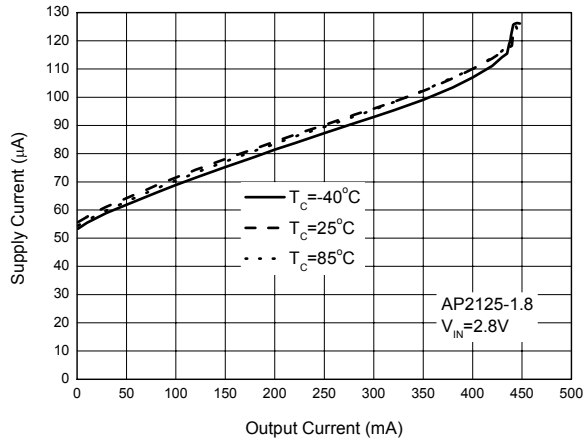

Figure 24. Supply Current vs. Output Current

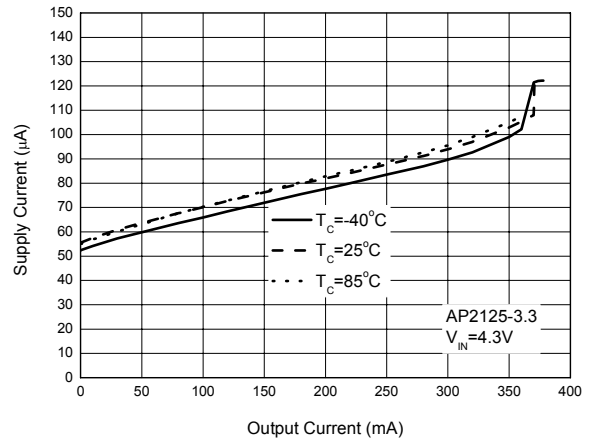

Figure 25. Supply Current vs. Output Current

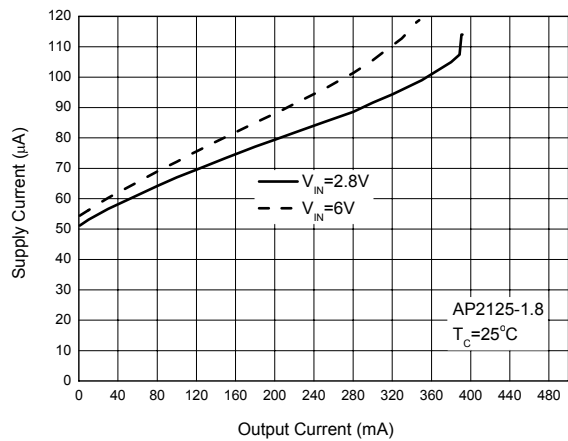

Figure 26. Supply Current vs. Output Current

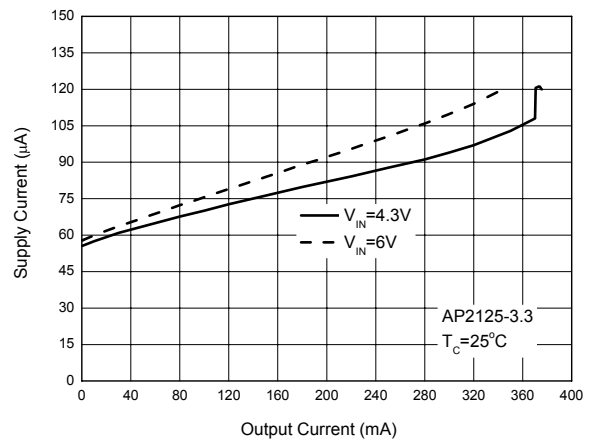

Figure 27. Supply Current vs. Output Current



Typical Performance Characteristics (Continued)

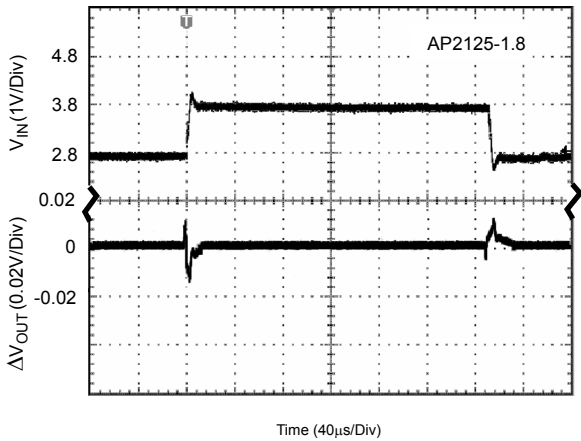

Figure 28. Line Transient  
(Conditions:  $I_{OUT}=30\text{mA}$ ,  $C_{OUT}=1\mu\text{F}$ ,  $V_{IN}=2.8$  to  $3.8\text{V}$ )

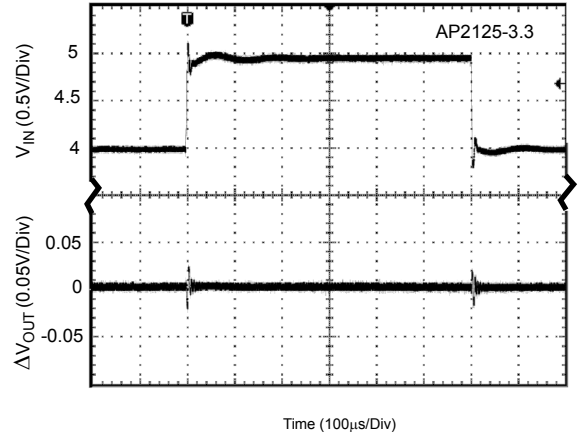

Figure 29. Line Transient  
(Conditions:  $I_{OUT}=30\text{mA}$ ,  $C_{OUT}=1\mu\text{F}$ ,  $V_{IN}=4$  to  $5\text{V}$ )

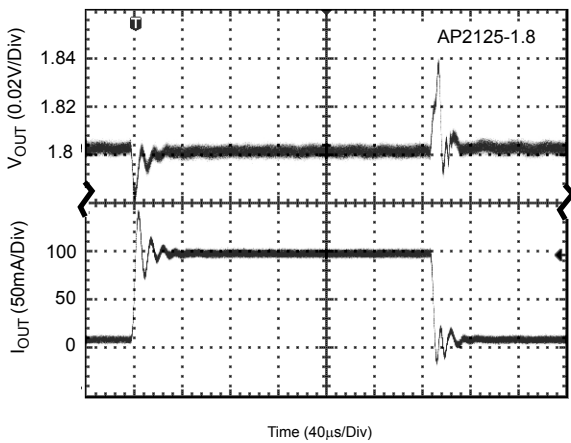

Figure 30. Load Transient  
(Conditions:  $I_{OUT}=10$  to  $100\text{mA}$ ,  $C_{IN}=1\mu\text{F}$ ,  $C_{OUT}=1\mu\text{F}$ ,  $V_{IN}=2.8\text{V}$ )

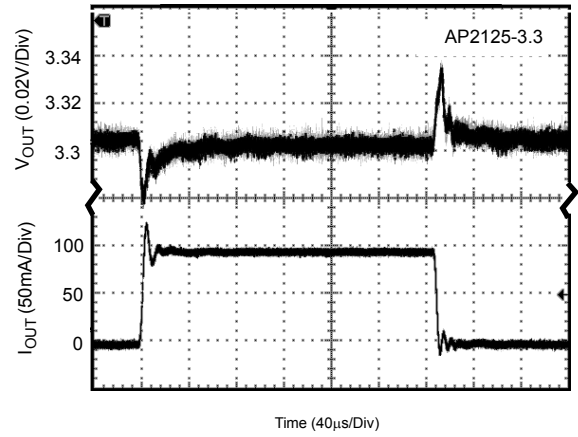

Figure 31. Load Transient  
(Conditions:  $I_{OUT}=10$  to  $100\text{mA}$ ,  $C_{IN}=1\mu\text{F}$ ,  $C_{OUT}=1\mu\text{F}$ ,  $V_{IN}=4.3\text{V}$ )



**300mA HIGH SPEED, EXTREMELY LOW NOISE CMOS LDO REGULATOR AP2125**

**Typical Performance Characteristics (Continued)**

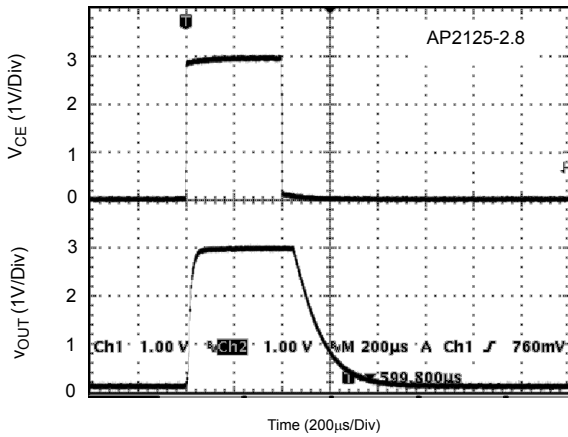

Figure 32. Enable Input Response and Auto-discharge  
(Conditions:  $V_{CE}=0$  to 3V,  $C_{IN}=1\mu F$ ,  
 $C_{OUT}=1\mu F$ ,  $V_{IN}=3V$ , no load)

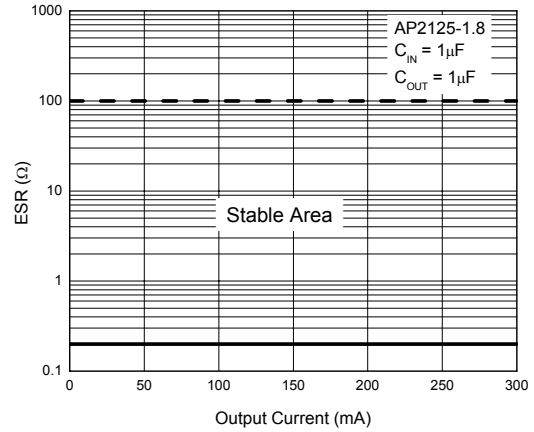

Figure 33. ESR vs. Output Current

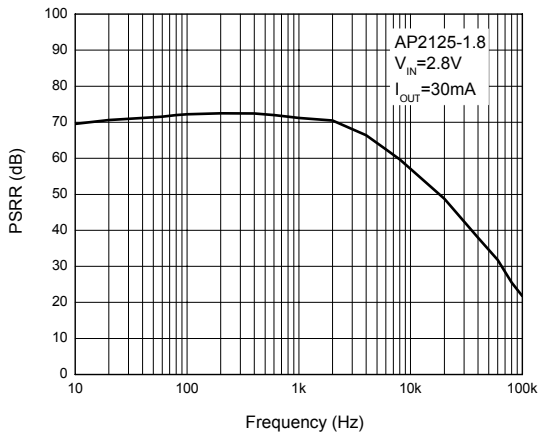

Figure 34. PSRR

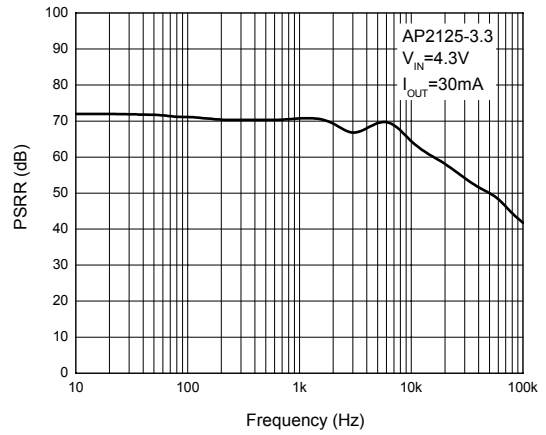

Figure 35. PSRR



**300mA HIGH SPEED, EXTREMELY LOW NOISE CMOS LDO REGULATOR AP2125**

**Typical Performance Characteristics (Continued)**

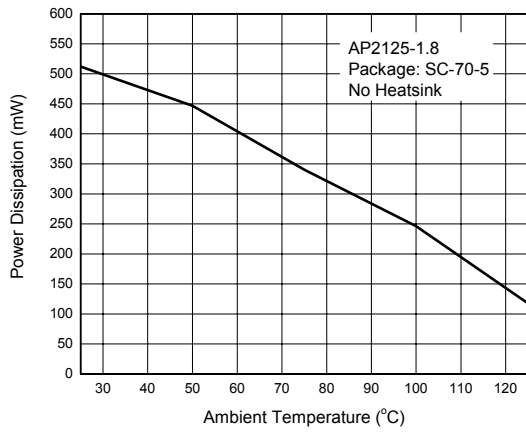

Figure 36. Power Dissipation vs. Ambient Temperature

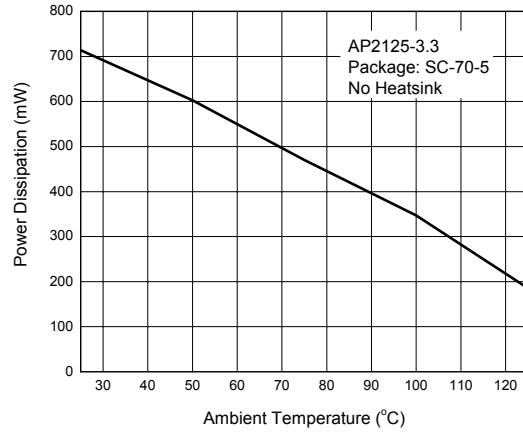

Figure 37. Power Dissipation vs. Ambient Temperature

**300mA HIGH SPEED, EXTREMELY LOW NOISE CMOS LDO REGULATOR AP2125**

**Typical Application**

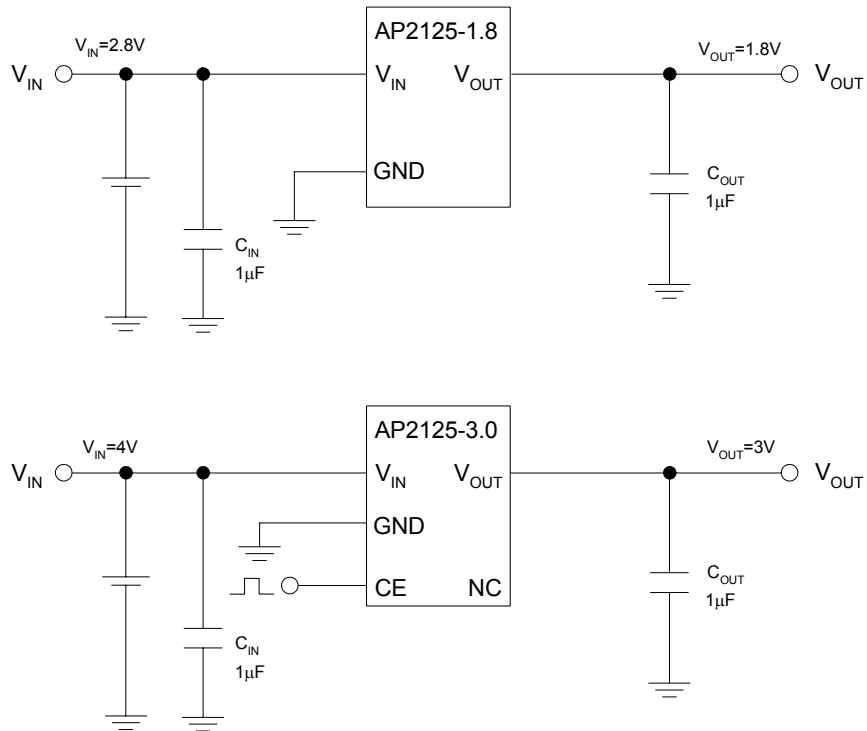

Figure 38. Typical Application of AP2125



Mechanical Dimensions

SOT-23-3

Unit: mm(inch)

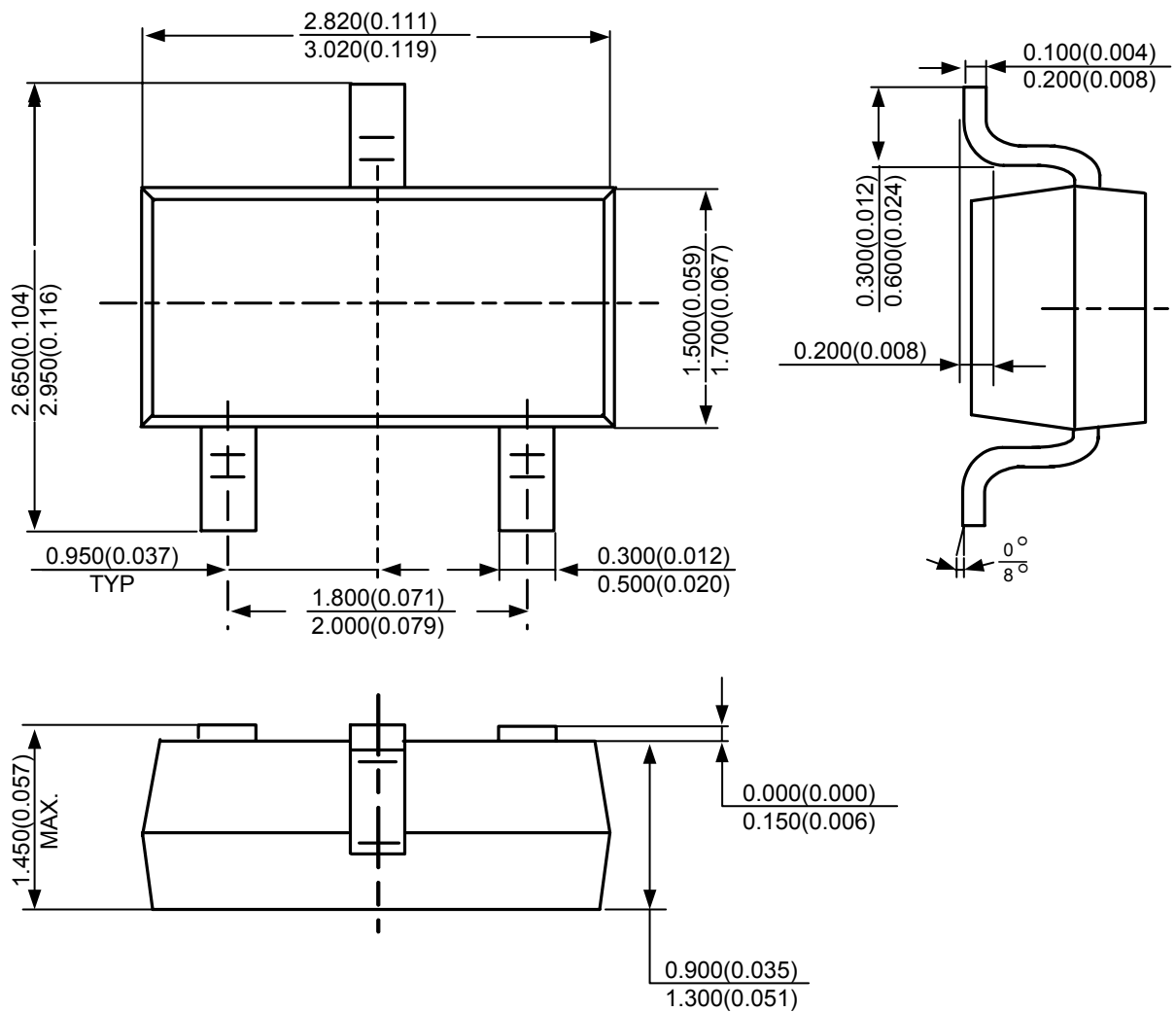



Mechanical Dimensions (Continued)

SOT-23-5

Unit: mm(inch)

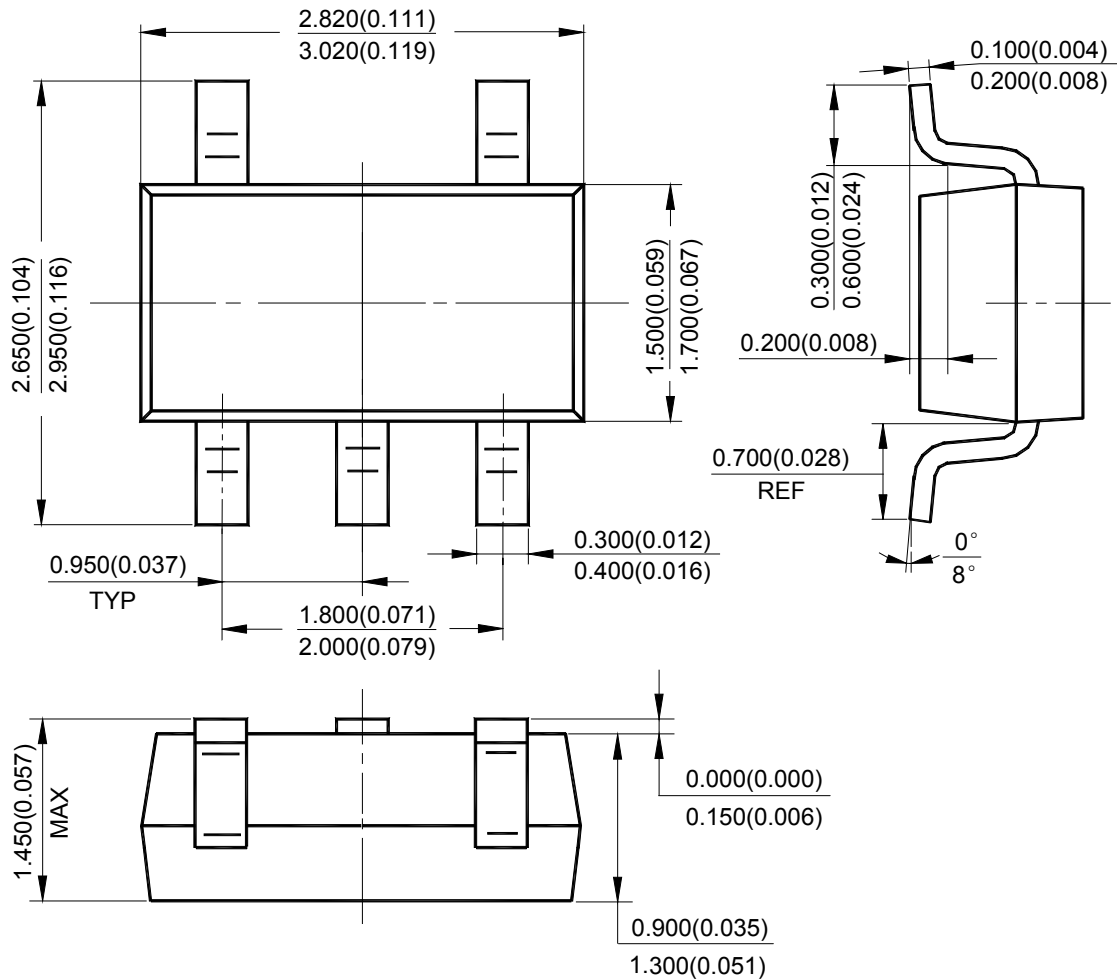





**Mechanical Dimensions (Continued)**

**SC-70-5**

**Unit: mm(inch)**

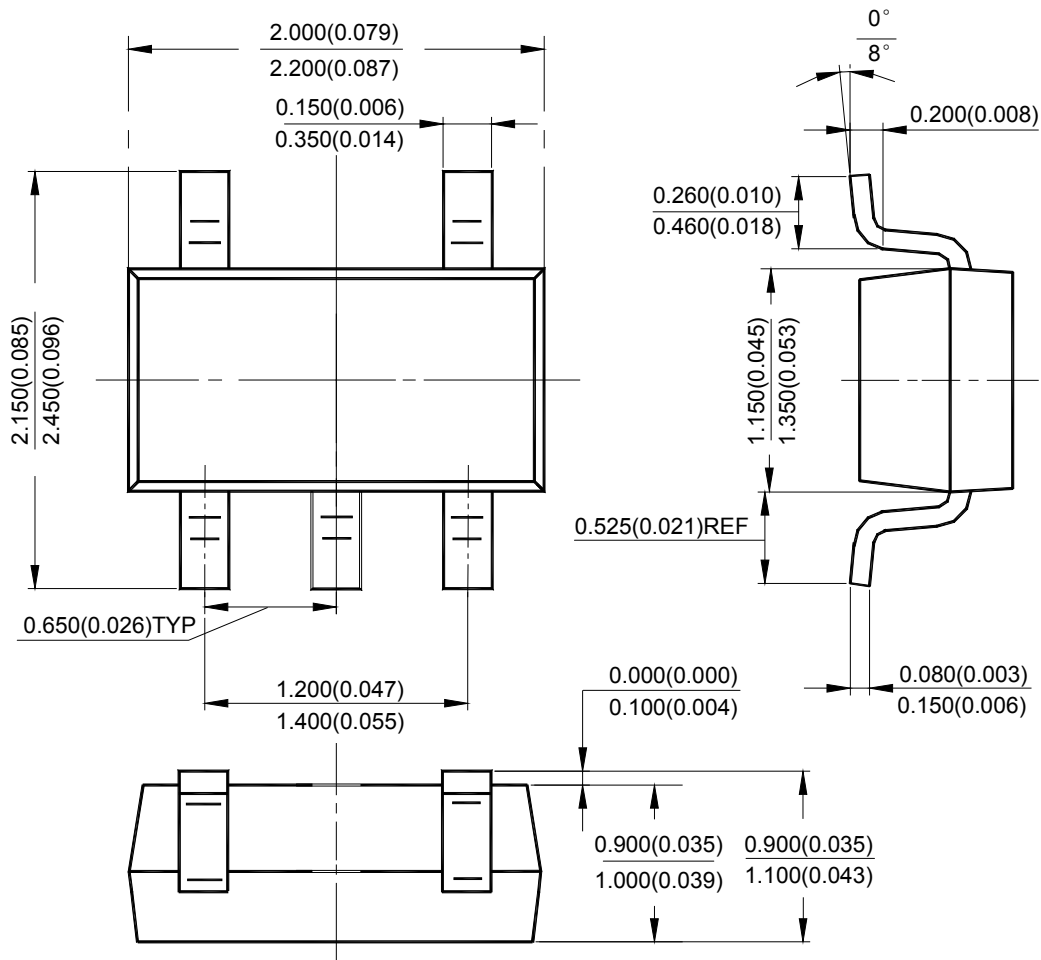



**Mechanical Dimensions (Continued)**

**SC-82**

**Unit: mm(inch)**

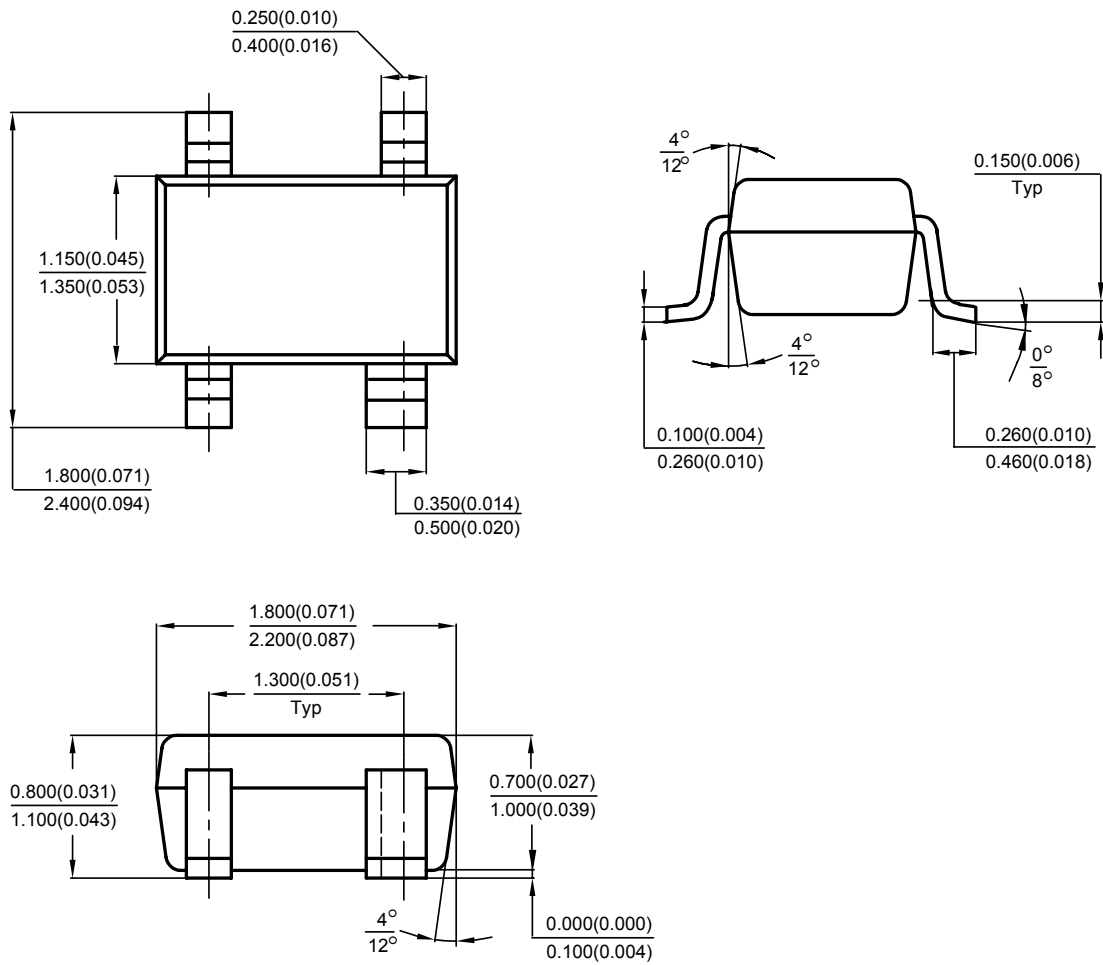



## BCD Semiconductor Manufacturing Limited

<http://www.bcdsemi.com>

### IMPORTANT NOTICE

BCD Semiconductor Manufacturing Limited reserves the right to make changes without further notice to any products or specifications herein. BCD Semiconductor Manufacturing Limited does not assume any responsibility for use of any its products for any particular purpose, nor does BCD Semiconductor Manufacturing Limited assume any liability arising out of the application or use of any its products or circuits. BCD Semiconductor Manufacturing Limited does not convey any license under its patent rights or other rights nor the rights of others.

---

#### MAIN SITE

##### - Headquarters

##### BCD Semiconductor Manufacturing Limited

No. 1600, Zi Xing Road, Shanghai ZiZhu Science-based Industrial Park, 200241, China  
Tel: +86-21-24162266, Fax: +86-21-24162277

##### - Wafer Fab

##### Shanghai SIM-BCD Semiconductor Manufacturing Co., Ltd.

800 Yi Shan Road, Shanghai 200233, China  
Tel: +86-21-6485 1491, Fax: +86-21-5450 0008

#### REGIONAL SALES OFFICE

##### Shenzhen Office

##### Shanghai SIM-BCD Semiconductor Manufacturing Co., Ltd., Shenzhen Office

Unit A Room 1203, Skyworth Bldg., Gaoxin Ave. 1.S., Nanshan District, Shenzhen, China  
Tel: +86-755-8826 7951  
Fax: +86-755-8826 7865

##### Taiwan Office

##### BCD Semiconductor (Taiwan) Company Limited

4F, 298-1, Rui Guang Road, Nei-Hu District, Taipei, Taiwan  
Tel: +886-2-2656 2808  
Fax: +886-2-2656 2806

##### USA Office

##### BCD Semiconductor Corp.

30920 Huntwood Ave. Hayward, CA 94544, USA  
Tel : +1-510-324-2988  
Fax: +1-510-324-2788