

CRYSTAL UNIT

YSX211SL Small Size



Applications

- SmartWearable IOT Communication.

Features

- Dimensions: 2.05 x 1.65 x 0.50 mm.
- Standard Frequency: 16~54MHz
- High precision and high frequency stability.
- Excellent heat resistance and environmental characteristics.



Specifications

Standard Frequency	16~54MHz or 96MHZ
Vibration Mode	AT Fundamental
Load Capacitance	8pF, 9pF, 12pF, or specify
Frequency Tolerance (at 25)	±10ppm, ±20ppm, or specify
Frequency Versus Temperature Characteristics	±20ppm, or specify
Operating Temperature	-40~+85℃
Storage Temperature	-40~+85℃ or specify
Shunt Capacitance	3 pF Max.
Level of Drive	10~200µW Max. (100uW typical)
Aging (at 25 °C)	±3ppm/year Max.

Equivalent Series Resistance(ESR)

16 ~ 30 MHz	100 Ω Max.
31 ~ 54 MHz	80 Ω Max.

Dimensions and Patterns [unit:mm]

Package Size – Dimensions (Unit: mm)	Recommended Land Pattern (Unit: mm)

CRYSTAL UNIT

YSX211SL Small Size



Reflow Soldering Profile

Pre Heating Temperature
 Tp1 ~ Tp2 = + 170 °C
 Heating Temperature
 TMI = + 220 °C
 Peak Temperature
 TMax. = + 260 °C
 Point of measuring
 In case of Solder ability
 Terminal.
 In case of Resistance to soldering heat
 Surface.

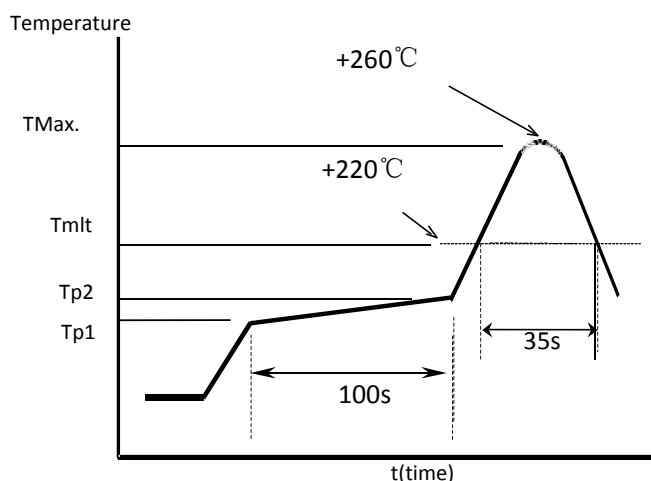

Taping Specification(Unit: mm)

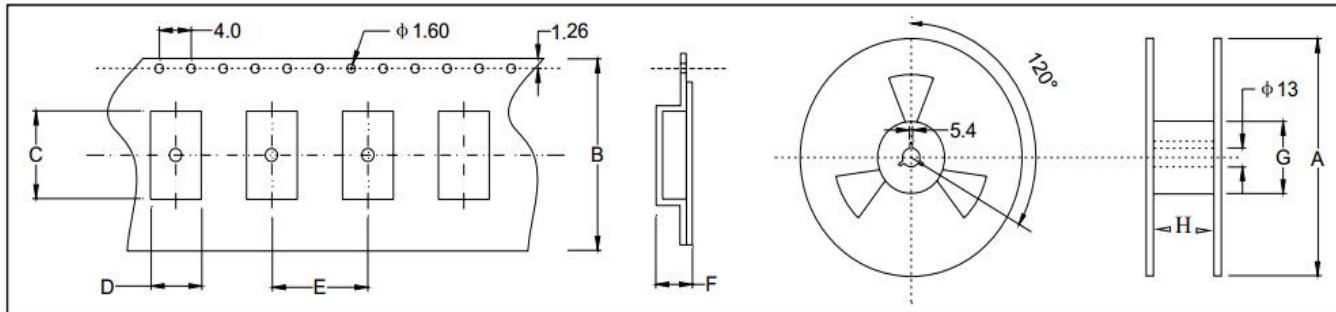

Size	A	B	C	D	E	F	G	H
SMD-2016	180±2.0	8.0±0.3	2.30±0.1	1.90±0.1	4.0±0.1	0.95±0.1	61.0±1.0	8.0±1.0

3000 pcs per reel