



**Applications**

- Phase Control
- Static Switching
- Light Dimming
- Motor Speed Control
- Kitchen Equipment
- Power Tools
- Solenoid Valve Controls:
  - Dishwashers
  - Washing Machines

- **Suitable for General Purpose AC Switching**
- **Altgernistor/No Snubber Versions for Inductive Loads**
- **Logic Level Available for Use with Microcontrollers and Low Level Devices**
- **IGT Range 5-50 mA (Q1)**
- **VDRM/VRMM 400, 600, 800, 1000V**

**Absolute Maximum Ratings**

	CONDITIONS	SYMBOL	RATING
RMS On-State Current (full sine wave)	T <sub>c</sub> = 110°C T <sub>c</sub> = 100°C	T0-220AB T0-220AB Iso	I <sub>T(RMS)</sub> 8A
Non Repetitive Surge Peak On-State Current (Full Cycle, T <sub>j</sub> Initial = 25°C)	F = 50 Hz F = 60 Hz	I <sub>TSM</sub>	80A 84A
I <sup>2</sup> t Value for fusing	tp = 10 ms	I <sup>2</sup> t	78A <sup>2</sup> s
Critical rate of rise of on-state current I <sub>G</sub> =2 x I <sub>GT</sub> , tr<100 ns, T <sub>j</sub> = 125°C	F = 120 Hz	di/dt	100A/μs
Peak Gate Current @ T <sub>j</sub> = 125°C	tp = 20 μs	I <sub>GM</sub>	4A
Average Gate Power Dissipation @ T <sub>j</sub> = 125°C		P <sub>G(AV)</sub>	1W
Storage Temperature Range		T <sub>stg</sub>	-40 to +150°C
Operating Junction Temperature Range		T <sub>j</sub>	-40 to +125°C
Isolation Voltage (CTA Series only)		V <sub>ISO</sub>	2500 V <sub>RMS</sub>

**Electrical Characteristics**

ALTERNISTOR/NO SNUBBER AND LOGIC LEVEL (3 Quadrants)		TW	SW	CW	BW
I <sub>GT</sub> MAX @ V <sub>D</sub> = 12 V, R <sub>L</sub> = 30Ω NOTE 1	QI-II-III	5mA	10mA	35mA	50mA
V <sub>GT</sub> MAX @ V <sub>D</sub> = 12 V, R <sub>L</sub> = 30Ω	QI-II-III	1.3V	1.3V	1.3V	1.3V
V <sub>GD</sub> MIN @ V <sub>D</sub> = V <sub>DRM</sub> , R <sub>L</sub> = 3.3kΩ	T <sub>j</sub> = 125°C QI-II-III	0.2V	0.2V	0.2V	0.2V
I <sub>H</sub> MAX @ I <sub>T</sub> = 500 mA NOTE 2		10mA	15mA	35mA	50mA
I <sub>L</sub> MAX @ I <sub>G</sub> = 1.2 I <sub>GT</sub>	QI-III	10mA	25mA	50mA	70mA
I <sub>L</sub> MAX @ I <sub>G</sub> = 1.2 I <sub>GT</sub>	Q-II	15mA	30mA	60mA	80mA
dv/dt MIN @ V <sub>D</sub> = 67%V <sub>DRM</sub> (gate open) NOTE 2	T <sub>j</sub> = 125°C	20V/μs	40V/μs	400V/μs	1000V/μs
(di/dt) <sub>c</sub> MIN @ (dv/dt) <sub>c</sub> = 0.1 V/ms NOTE 2	T <sub>j</sub> = 125°C	3.5A/ms	5.4A/ms		
(di/dt) <sub>c</sub> MIN @ (dv/dt) <sub>c</sub> = 10 V/ms NOTE 2	T <sub>j</sub> = 125°C	1.5A/ms	2.8A/ms		
(di/dt) <sub>c</sub> MIN without Snubber NOTE 2 & 4	T <sub>j</sub> = 125°C			4.5A/ms	7A/ms

**STANDARD (4 Quadrants)**

		C	B
I <sub>GT</sub> MAX @ V <sub>D</sub> = 12 V, R <sub>L</sub> = 30Ω NOTE 1	QI-II-III	25mA	50mA
I <sub>GT</sub> MAX @ V <sub>D</sub> = 12 V, R <sub>L</sub> = 30Ω NOTE 1	QIV	50mA	100mA
V <sub>GT</sub> MAX @ V <sub>D</sub> = 12 V, R <sub>L</sub> = 30Ω	Q-All		1.3V
V <sub>GD</sub> MIN @ V <sub>D</sub> = V <sub>DRM</sub> , R <sub>L</sub> = 3.3kΩ	T <sub>j</sub> = 125°C Q-All		0.2V
I <sub>H</sub> MAX @ I <sub>T</sub> = 500 mA NOTE 2		25mA	50mA
I <sub>L</sub> MAX @ I <sub>G</sub> = 1.2 I <sub>GT</sub>	QI-III-IV	40mA	50mA
I <sub>L</sub> MAX @ I <sub>G</sub> = 1.2 I <sub>GT</sub>	Q-II	80mA	100mA
dv/dt MIN @ V <sub>D</sub> = 67%V <sub>DRM</sub> (gate open) NOTE 2	T <sub>j</sub> = 125°C	200V/μs	400V/μs
(dv/dt) <sub>c</sub> MIN @ (di/dt) <sub>c</sub> = 3.5 A/ms NOTE 4	T <sub>j</sub> = 125°C	5V/μs	10V/μs

**GENERAL NOTES**

1. Minimum IGT is guaranteed at 5% of IGT max.
2. For both polarities of A2 referenced to A1
3. All parameters at 25 degrees C unless otherwise specified.
4. Commutating dv/dt=50V.μsec (exponential to 200Vpk)

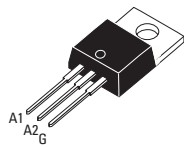

TO-220AB Isolated (CTA08)

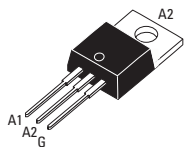

TO-220AB Non-Isolated (CTB08)



## Static Characteristics

$V_T$ MAX @ $I_{TM} = 11$ A, $t_p = 380\mu s$ NOTE 2	$T_j = 25^\circ C$	1.55V
$V_{TO}$ MAX @ Threshold Voltage NOTE 2	$T_j = 125^\circ C$	0.85V
$R_d$ MAX @ Dynamic Resistance NOTE 2	$T_j = 125^\circ C$	50mΩ
$I_{DRM}$ MAX @ $V_{DRM} = V_{RRM}$	$T_j = 25^\circ C$	5μA
$I_{RRM}$ MAX @ $V_{DRM} = V_{RRM}$	$T_j = 125^\circ C$	1mA

## Thermal Resistances

	SYMBOL	RATING
Junction to Case (AC)	TO-220AB	$R_{th(j-c)}$ 1.6°C/W
Junction to Case (AC)	TO-220AB Isolated	$R_{th(j-c)}$ 2.5°C/W
Junction to Ambient	TO-220AB	$R_{th(j-a)}$ 60°C/W
Junction to Ambient	TO-220AB Isolated	$R_{th(j-a)}$ 60°C/W

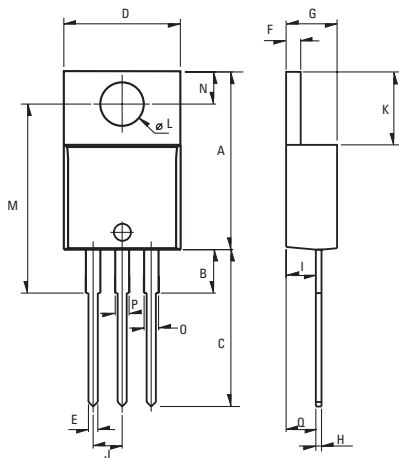

Weight: 2.3g (0.08 oz)

## Dimensions

REF.	Millimeters			Inches		
	Min.	Typ.	Max.	Min.	Typ.	Max.
A	15.24		15.75	0.6		0.62
B		3.23			0.127	
C	12.78		13.79	0.503		0.543
D	9.96		10.36	0.392		0.408
E	0.69		0.94	0.027		0.037
F	1.22		1.32	0.048		0.052
G	4.62		4.83	0.182		0.19
H	0.46		0.61	0.018		0.024
I	2.49		2.84	0.098		0.112
J	2.39		2.69	0.094		0.106
K	6.48		6.88	0.255		0.271
L	3.78		3.89	0.149		0.153
M	15.49	16	16.51	0.61	0.63	0.65
N	2.59		2.9	0.102		0.114
O	0.99		1.55	0.039		0.061
P	0.99		1.55	0.039		0.061
Q		2.67			0.105	

## Part Number Selection

Part Number	Voltage [Vpk]	$I_{GT}$ [mA]	Type	Package
CTA/CTB08-xxxB	400, 600, 800, 1000	50mA	Standard	TO-220AB
CTA/CTB08-xxxBW	400, 600, 800, 1000	50mA	Alternistor/No Snubber	TO-220AB
CTA/CTB08-xxxC	400, 600, 800, 1000	25mA	Standard	TO-220AB
CTA/CTB08-xxxCW	400, 600, 800, 1000	35mA	Alternistor/No Snubber	TO-220AB
CTA/CTB08-xxxSW	400, 600, 800, 1000	10mA	Logic Level	TO-220AB
CTA/CTB08-xxxTW	400, 600, 800, 1000	5mA	Logic Level	TO-220AB

## Part Number Designation

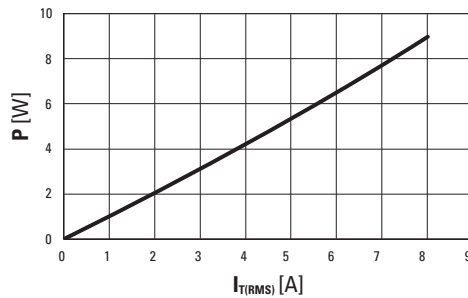
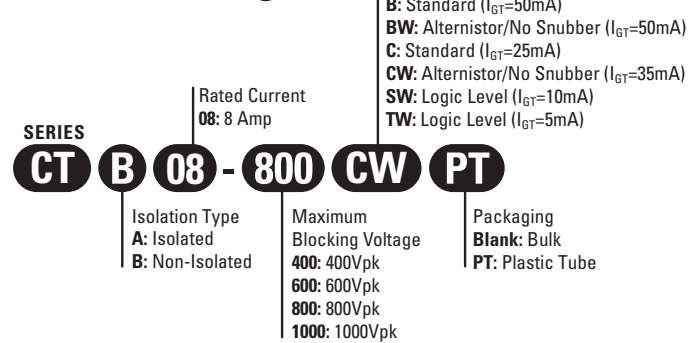

Fig. 1: Power dissipation versus RMS on-state current (full cycle).

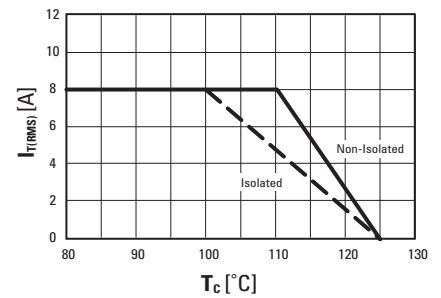

Fig. 2: RMS on-state current versus case temperature (full cycle)

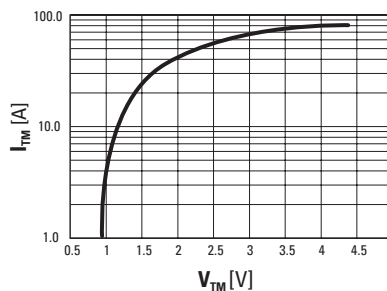

Fig. 3: On-state current versus on-state voltage (instantaneous values)

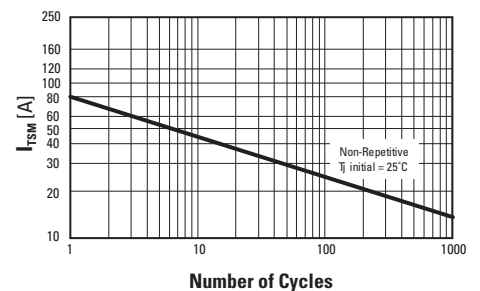

Fig. 4: Non-repetitive surge peak on-state current versus number of cycles.

ISO9001 CERTIFIED

## Approvals

UL Recognized Component - E72445 (CTA Series)

### USA

Sales & Tech Support (866) 258-5057  
 Email: sales@cynergy3.com  
 Cynergy3 Components  
 2320 Paseo de las Americas, Suite 104  
 San Diego, CA 92154

### EUROPE - UK

Telephone +44 (0) 1202 897969  
 Fax +44 (0) 1202 891918  
 Email: sales@cynergy3.com  
 Cynergy3 Components Ltd.  
 7 Cobham Road  
 Ferndown Industrial Estate  
 Wimborne, Dorset BH21 7PE

### ASIA - Thailand

Telephone +66 (0)2 665 2517  
 Fax +66 (0)2 665 2588  
 Cynergy 3 Components, Asia  
 18/8 Fico Place 12th Floor  
 Soi Sukhumvit 21 (Asoke)  
 Klongtoey Nua, Wattana  
 Bangkok, Thailand 10110