

flowPIM 1 3rd gen

1200V / 35A

Features

- 3- rectifier, BRC, Inverter, NTC
- Very compact housing, easy to route
- IGBT4 / EmCon4 technology for low saturation losses and improved EMC behaviour
- High performance with AlN substrate

Target Applications

- Motor Drives
- Power Generation

Types

- V23990-P580-A46-PM

flowPIM1 housing

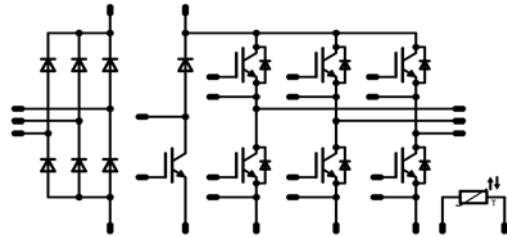
Schematic

Maximum Ratings

 T_j=25°C, unless otherwise specified

Parameter	Symbol	Condition	Value	Unit
Input Rectifier Diode				
Peak repetitive reverse voltage	V _{RRM}		1600	V
Forward current per diode	I _{FAV}	DC current T _n =80°C	50	A
Surge forward current	I _{FSM}	t _p =10ms T _j =45°C	320	A
I ² t-value	I ² t		510	A ² s
Power dissipation per diode	P _{tot}	T _j =T _{jmax} T _n =80°C	82	W
Maximum junction temperature	T _{jmax}		150	°C
Inverter Transistor				
Collector-emitter break down voltage	V _{CE}		1200	V
DC collector current	I _C	T _j =T _{jmax} T _n =80°C	49	A
Repetitive peak collector current	I _{Cpulse}	t _p limited by T _{jmax}	105	A
Power dissipation per IGBT	P _{tot}	T _j =T _{jmax} T _n =80°C	152	W
Gate-emitter peak voltage	V _{GE}		±20	V
Short circuit ratings	t _{SC} V _{CC}	T _j ≤150°C V _{GE} =15V	10 800	µs V
Maximum junction temperature	T _{jmax}		175	°C

Maximum Ratings

 $T_j=25^{\circ}\text{C}$, unless otherwise specified

Parameter	Symbol	Condition	Value	Unit
-----------	--------	-----------	-------	------

Inverter Diode

Peak repetitive reverse voltage	V_{RRM}	$T_j=25^{\circ}\text{C}$	1200	V
DC forward current	I_F	$T_j=T_{jmax}$ $T_h=80^{\circ}\text{C}$	50	A
Repetitive peak forward current	I_{FRM}	t_p limited by T_{jmax}	70	A
Power dissipation per diode	P_{tot}	$T_j=T_{jmax}$ $T_h=80^{\circ}\text{C}$	121	W
Maximum junction temperature	T_{jmax}		175	$^{\circ}\text{C}$

Brc Transistor

Collector-emitter break down voltage	V_{CE}		1200	V
DC collector current	I_C	$T_j=T_{jmax}$ $T_h=80^{\circ}\text{C}$	40	A
Repetitive peak collector current	I_{Cpuls}	t_p limited by T_{jmax}	75	A
Power dissipation per IGBT	P_{tot}	$T_j=T_{jmax}$ $T_h=80^{\circ}\text{C}$	133	W
Gate-emitter peak voltage	V_{GE}		± 20	V
Short circuit ratings	t_{SC} V_{CC}	$T_j \leq 150^{\circ}\text{C}$ $V_{GE} = 15\text{V}$	10 800	μs V
Maximum junction temperature	T_{jmax}		175	$^{\circ}\text{C}$

Brc Diode

Peak repetitive reverse voltage	V_{RRM}	$T_j=25^{\circ}\text{C}$	1200	V
DC forward current	I_F	$T_j=T_{jmax}$ $T_h=80^{\circ}\text{C}$	20	A
Repetitive peak forward current	I_{FRM}	t_p limited by T_{jmax}	20	A
Power dissipation per diode	P_{tot}	$T_j=T_{jmax}$ $T_h=80^{\circ}\text{C}$	59	W
Maximum junction temperature	T_{jmax}		175	$^{\circ}\text{C}$

Thermal Properties

Storage temperature	T_{stg}		-40...+125	$^{\circ}\text{C}$
Operation temperature under switching condition	T_{op}		-40...+($T_{jmax} - 25$)	$^{\circ}\text{C}$

Insulation Properties

Insulation voltage	V_{is}	$t=2\text{s}$ DC voltage	4000	V
Creepage distance			min 12.7	mm
Clearance			min 12.7	mm

Characteristic Values

Parameter	Symbol	Conditions					Value			Unit	
		$V_{GE}[V]$ or $V_{GS}[V]$	$V_r[V]$ or $V_{CE}[V]$ or $V_{DS}[V]$	$I_c[A]$ or $I_F[A]$ or $I_D[A]$	T_j	Min	Typ	Max			
Input Rectifier Diode											
Forward voltage	V_F				50	$T_j=25^\circ C$ $T_j=125^\circ C$	0.8	1.29 1.24	1.6	V	
Threshold voltage (for power loss calc. only)	V_{td}				50	$T_j=25^\circ C$ $T_j=125^\circ C$		0.93 0.82		V	
Slope resistance (for power loss calc. only)	r_t				50	$T_j=25^\circ C$ $T_j=125^\circ C$		0.007 0.009		Ω	
Reverse current	I_r			1500		$T_j=25^\circ C$ $T_j=125^\circ C$			0.02 2	mA	
Thermal resistance chip to heatsink per chip	R_{thJH}	Thermal foil thickness=76um						0.85		K/W	
Thermal resistance chip to case per chip	R_{thJC}	Kunze foil KU-ALF5						N/A			
Inverter Transistor											
Gate emitter threshold voltage	$V_{GE(th)}$	VCE=VGE			0.0012	$T_j=25^\circ C$ $T_j=150^\circ C$	5	5.8	6.5	V	
Collector-emitter saturation voltage	$V_{CE(sat)}$		15		35	$T_j=25^\circ C$ $T_j=150^\circ C$	1.6	1.95 2.39	2.3	V	
Collector-emitter cut-off current incl. diode	I_{CES}		0	1200		$T_j=25^\circ C$ $T_j=150^\circ C$			0.01	mA	
Gate-emitter leakage current	I_{GES}		20	0		$T_j=25^\circ C$ $T_j=150^\circ C$			200	nA	
Integrated gate resistor	R_{gint}							-		Ω	
Turn-on delay time	$t_{d(on)}$	Rgoff=16 Ω Rgon=16 Ω	± 15	600	35	$T_j=25^\circ C$		92		ns	
Rise time	t_r					$T_j=150^\circ C$		91.6			
Turn-off delay time	$t_{d(off)}$					$T_j=25^\circ C$		18			
Fall time	t_f					$T_j=150^\circ C$		23.4			
Turn-on energy loss per pulse	E_{on}					$T_j=25^\circ C$		213			
Turn-off energy loss per pulse	E_{off}	$T_j=150^\circ C$		274							
Input capacitance	C_{ies}	f=1MHz	0	25		$T_j=25^\circ C$		1950		pF	
Output capacitance	C_{oss}						$T_j=25^\circ C$		155		
Reverse transfer capacitance	C_{rss}								115		
Gate charge	Q_{Gate}	Vcc=960V	± 15		35	$T_j=25^\circ C$		270		nC	
Thermal resistance chip to heatsink per chip	R_{thJH}	Thermal foil thickness=76um						0.62		K/W	
Thermal resistance chip to case per chip	R_{thJC}	Kunze foil KU-ALF5						N/A			
Inverter Diode											
Diode forward voltage	V_F				35	$T_j=25^\circ C$ $T_j=150^\circ C$	1	1.83 1.8	2.2	V	
Peak reverse recovery current	I_{RRM}	Rgoff=16 Ω	± 15	600	35	$T_j=25^\circ C$		68.9		A	
Reverse recovery time	t_{rr}					$T_j=150^\circ C$		78.7			
Reverse recovered charge	Q_{rr}					$T_j=25^\circ C$		150			
Peak rate of fall of recovery current	$di(rec)max/dt$					$T_j=150^\circ C$		277			
Reverse recovered energy	E_{rec}					$T_j=25^\circ C$		3.93			
Thermal resistance chip to heatsink per chip	R_{thJH}	Thermal foil thickness=76um						0.78		K/W	
Thermal resistance chip to case per chip	R_{thJC}	Kunze foil KU-ALF5						N/A			

Characteristic Values

Parameter	Symbol	Conditions					Value			Unit
		$V_{GE}[V]$ or $V_{GS}[V]$	$V_r[V]$ or $V_{CE}[V]$ or $V_{DS}[V]$	$I_c[A]$ or $I_F[A]$ or $I_b[A]$	T_j	Min	Typ	Max		
Brc Transistor										
Gate emitter threshold voltage	$V_{GE(th)}$	VCE=VGE			0.00085	$T_j=25^\circ C$ $T_j=150^\circ C$	5	5.8	6.5	V
Collector-emitter saturation voltage	$V_{CE(sat)}$		15		25	$T_j=25^\circ C$ $T_j=150^\circ C$	1.6	1.86 2.31	2.2	V
Collector-emitter cut-off incl. diode	I_{CES}		0	1200		$T_j=25^\circ C$ $T_j=150^\circ C$			0.005	mA
Gate-emitter leakage current	I_{GES}		20	0		$T_j=25^\circ C$ $T_j=150^\circ C$			200	nA
Integrated gate resistor	R_{gint}							-		Ω
Turn-on delay time	$t_{d(on)}$	Rgon=32 Ω Rgoff=32 Ω	± 15	600	25	$T_j=25^\circ C$		127		ns
Rise time	t_r					$T_j=150^\circ C$		129		
Turn-off delay time	$t_{d(off)}$					$T_j=25^\circ C$		36		
Fall time	t_f					$T_j=150^\circ C$		41.8		
Turn-on energy loss per pulse	E_{on}					$T_j=25^\circ C$		232		
Turn-off energy loss per pulse	E_{off}	$T_j=150^\circ C$		276						
Input capacitance	C_{ies}	f=1MHz	0	25		$T_j=25^\circ C$		1430		pF
Output capacitance	C_{oss}							115		
Reverse transfer capacitance	C_{rss}							85		
Gate charge	Q_{Gate}	Vcc=960V	± 15		25	$T_j=25^\circ C$		200		nC
Thermal resistance chip to heatsink per chip	R_{thJH}	Thermal foil thickness=76um						0.71		K/W
Thermal resistance chip to case per chip	R_{thJC}	Kunze foil KU-ALF5						N/A		
Brc Diode										
Diode forward voltage	V_F				10	$T_j=25^\circ C$ $T_j=150^\circ C$	1.3	1.85 1.76	2.2	V
Reverse leakage current	I_r		± 15	600	10	$T_j=25^\circ C$ $T_j=150^\circ C$			5	μA
Peak reverse recovery current	I_{RRM}	Rgon=32 Ω	± 15	600	10	$T_j=25^\circ C$		10.2		A
Reverse recovery time	t_{rr}					$T_j=150^\circ C$		12.3		
Reverse recovered charge	Q_{rr}					$T_j=25^\circ C$		396		
						$T_j=150^\circ C$		624		
Peak rate of fall of recovery current	$di(rec)max/dt$					$T_j=25^\circ C$		1.55		
Reverse recovery energy	E_{rec}	$T_j=150^\circ C$		3.03						
		$T_j=25^\circ C$		36						
Thermal resistance chip to heatsink per chip	R_{thJH}	Thermal foil thickness=76um						1.62		K/W
Thermal resistance chip to case per chip	R_{thJC}	Kunze foil KU-ALF5						N/A		
Thermistor										
Rated resistance	R					$T_j=25^\circ C$ $T_j=125^\circ C$	20.9	22 0.75	23.1	k Ω
Operating current	I					$T_j=25^\circ C$			0.3	mA
Power dissipation	P					$T_j=25^\circ C$		200		mW
B-value	$B_{(25/50)}$	Tol. $\pm 3\%$				$T_j=25^\circ C$		3950		K

Output Inverter

Figure 1 Output inverter IGBT

Typical output characteristics

$I_C = f(V_{CE})$

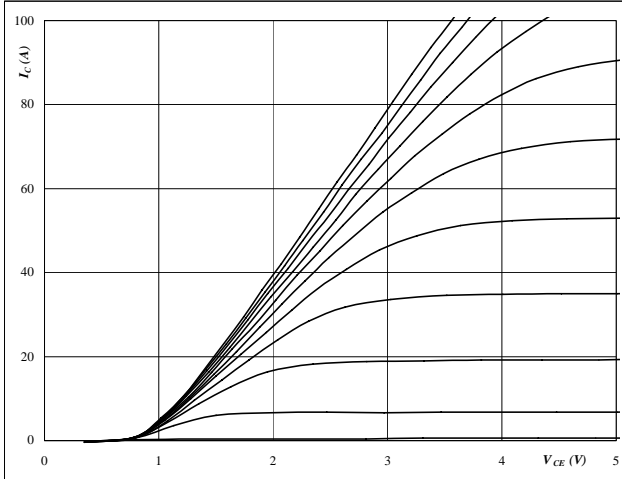

At
 $t_p = 250 \mu s$
 $T_j = 25 \text{ } ^\circ C$
 V_{GE} from 7 V to 17 V in steps of 1 V

Figure 2 Output inverter IGBT

Typical output characteristics

$I_C = f(V_{CE})$

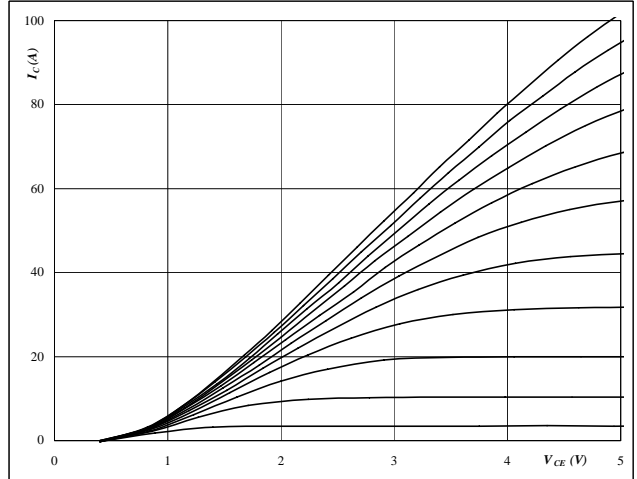

At
 $t_p = 250 \mu s$
 $T_j = 150 \text{ } ^\circ C$
 V_{GE} from 7 V to 17 V in steps of 1 V

Figure 3 Output inverter IGBT

Typical transfer characteristics

$I_C = f(V_{GE})$

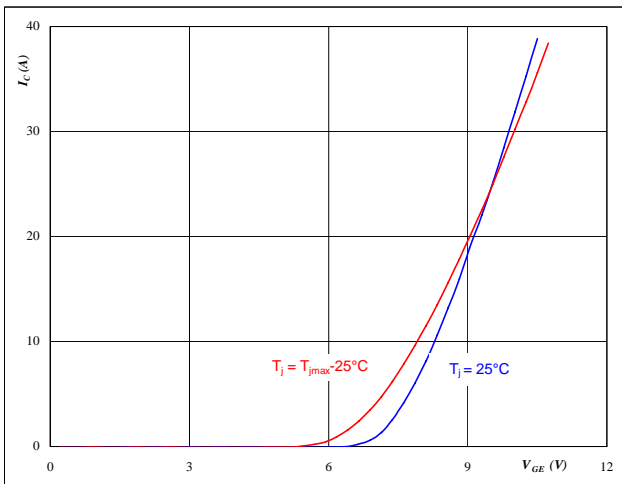

At
 $t_p = 250 \mu s$
 $V_{CE} = 10 V$

Figure 4 Output inverter FRED

Typical diode forward current as a function of forward voltage

$I_F = f(V_F)$

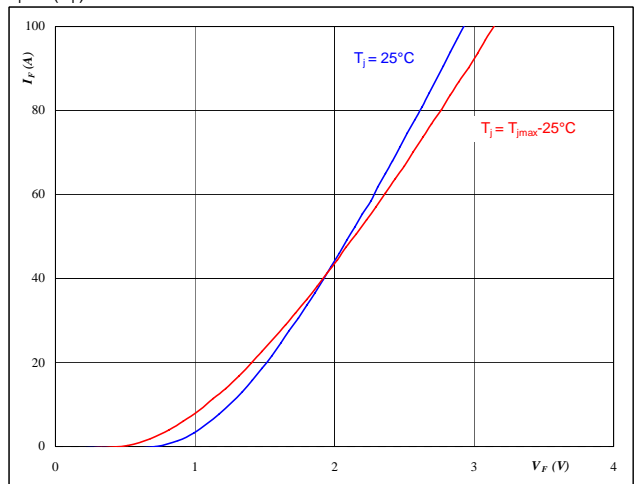

At
 $t_p = 250 \mu s$

Output Inverter

Figure 5 Output inverter IGBT

Typical switching energy losses
 as a function of collector current

$$E = f(I_C)$$

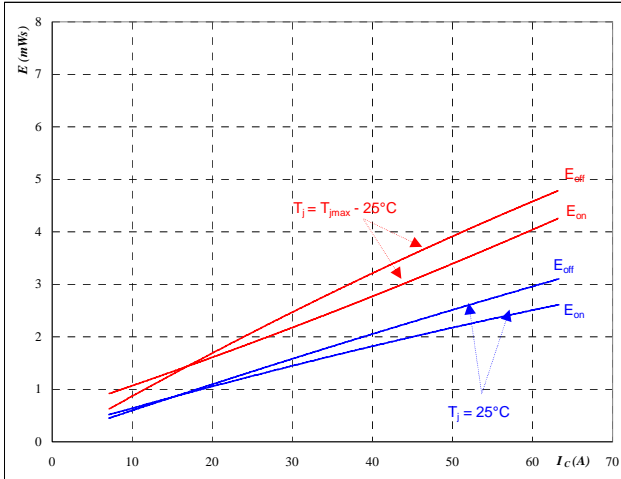

With an inductive load at

$T_j =$	25/150	°C
$V_{CE} =$	600	V
$V_{GE} =$	±15	V
$R_{gon} =$	16	Ω
$R_{goff} =$	16	Ω

Figure 6 Output inverter IGBT

Typical switching energy losses
 as a function of gate resistor

$$E = f(R_G)$$

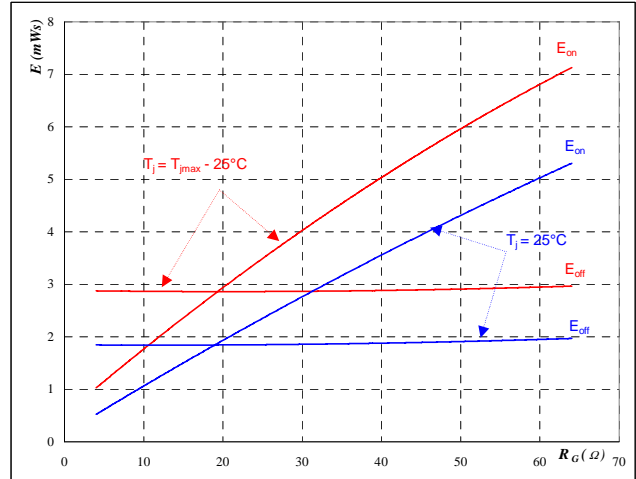

With an inductive load at

$T_j =$	25/150	°C
$V_{CE} =$	600	V
$V_{GE} =$	±15	V
$I_C =$	35	A

Figure 7 Output inverter IGBT

Typical reverse recovery energy loss
 as a function of collector current

$$E_{rec} = f(I_C)$$

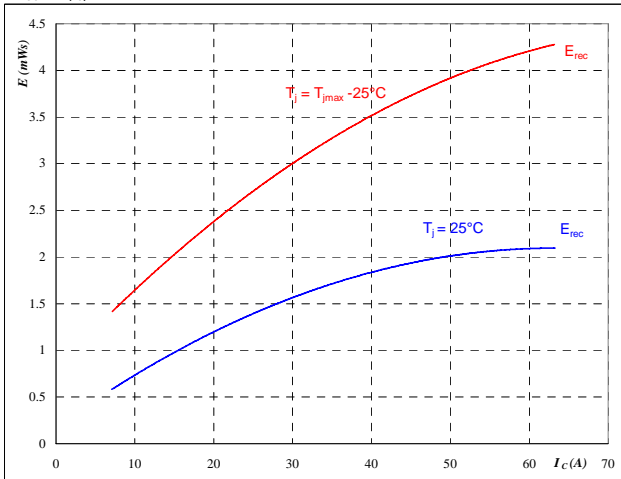

With an inductive load at

$T_j =$	25/150	°C
$V_{CE} =$	600	V
$V_{GE} =$	±15	V
$R_{gon} =$	16	Ω

Figure 8 Output inverter IGBT

Typical reverse recovery energy loss
 as a function of gate resistor

$$E_{rec} = f(R_G)$$

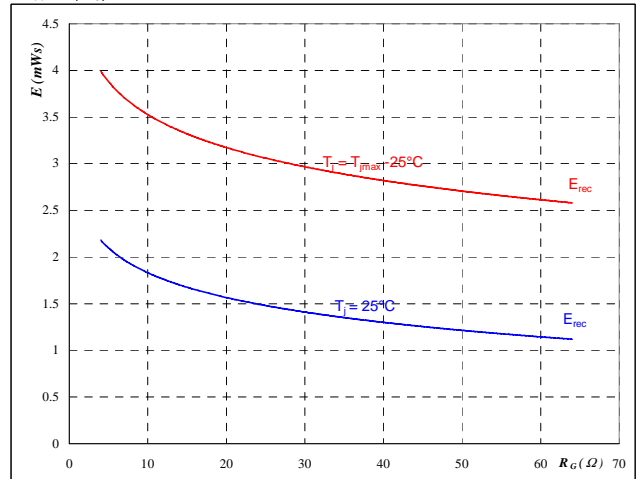

With an inductive load at

$T_j =$	25/150	°C
$V_{CE} =$	600	V
$V_{GE} =$	±15	V
$I_C =$	35	A

Output Inverter

Figure 9 Output inverter IGBT

Typical switching times as a function of collector current

$$t = f(I_C)$$

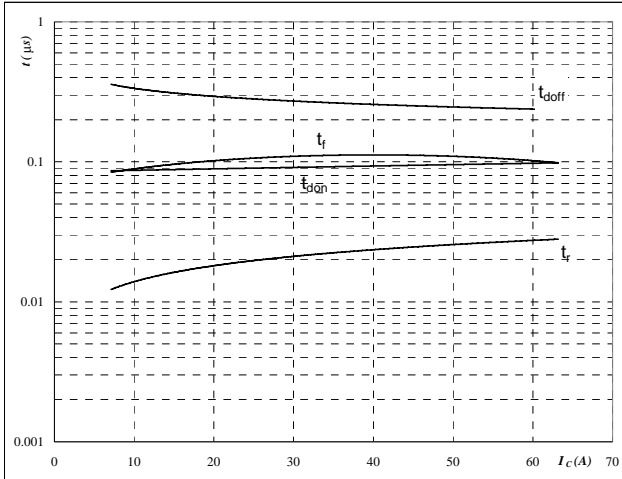

With an inductive load at

$T_j =$	150	°C
$V_{CE} =$	600	V
$V_{GE} =$	±15	V
$R_{gon} =$	16	Ω
$R_{goff} =$	16	Ω

Figure 10 Output inverter IGBT

Typical switching times as a function of gate resistor

$$t = f(R_G)$$

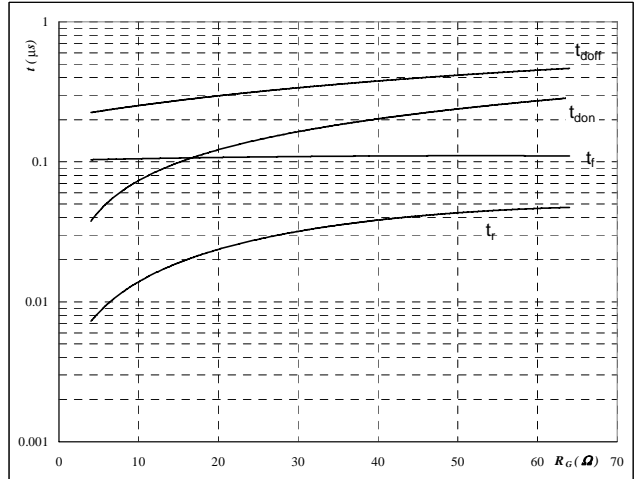

With an inductive load at

$T_j =$	150	°C
$V_{CE} =$	600	V
$V_{GE} =$	±15	V
$I_C =$	35	A

Figure 11 Output inverter FRED

Typical reverse recovery time as a function of collector current

$$t_{rr} = f(I_C)$$

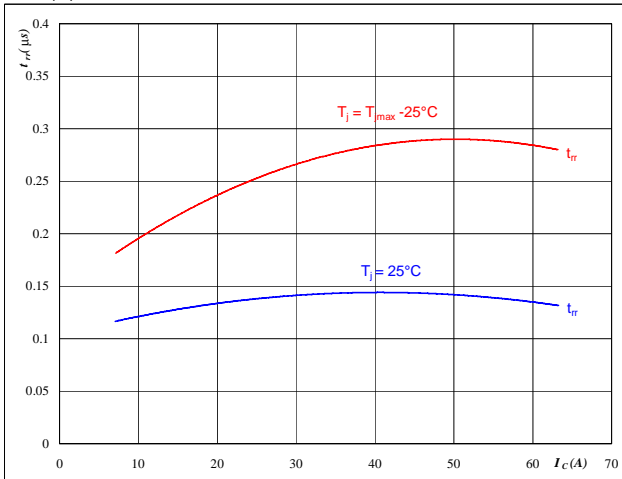

At

$T_j =$	25/150	°C
$V_{CE} =$	600	V
$V_{GE} =$	±15	V
$R_{gon} =$	16	Ω

Figure 12 Output inverter FRED

Typical reverse recovery time as a function of IGBT turn on gate resistor

$$t_{rr} = f(R_{gon})$$

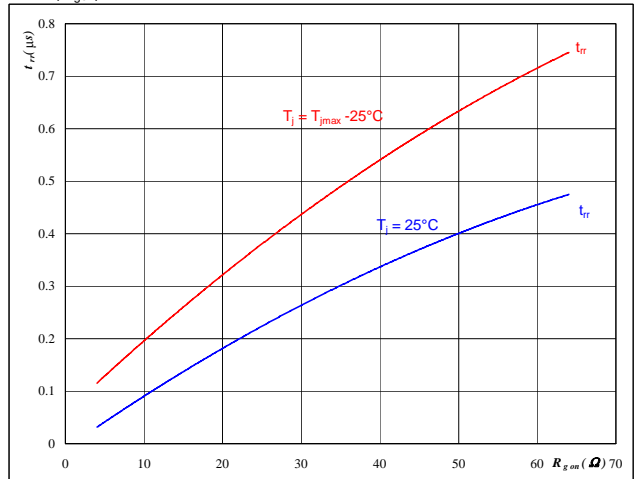

At

$T_j =$	25/150	°C
$V_R =$	600	V
$I_F =$	35	A
$V_{GE} =$	±15	V

Output Inverter

Figure 13 Output inverter FRED

Typical reverse recovery charge as a function of collector current

$$Q_{rr} = f(I_C)$$

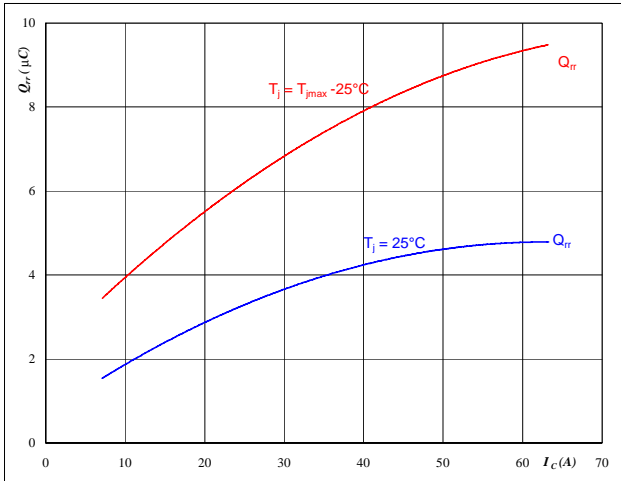

At

$T_j =$	25/150	°C
$V_{CE} =$	600	V
$V_{GE} =$	±15	V
$R_{gon} =$	16	Ω

Figure 14 Output inverter FRED

Typical reverse recovery charge as a function of IGBT turn on gate resistor

$$Q_{rr} = f(R_{gon})$$

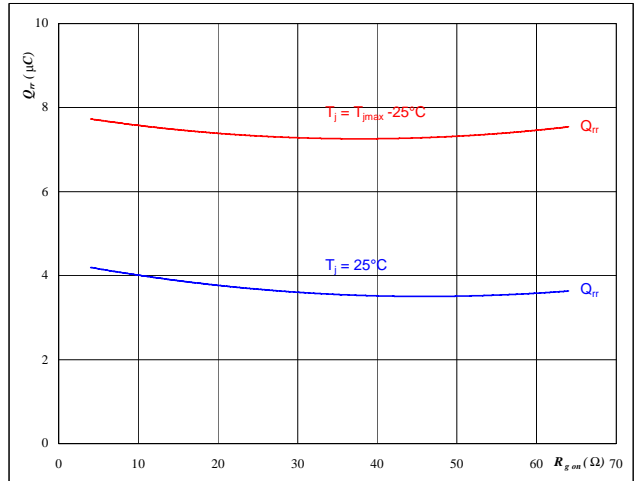

At

$T_j =$	25/150	°C
$V_R =$	600	V
$I_F =$	35	A
$V_{GE} =$	±15	V

Figure 15 Output inverter FRED

Typical reverse recovery current as a function of collector current

$$I_{RRM} = f(I_C)$$

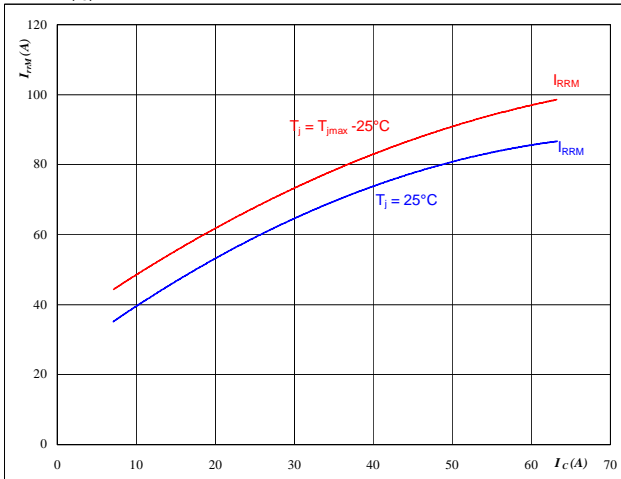

At

$T_j =$	25/150	°C
$V_{CE} =$	600	V
$V_{GE} =$	±15	V
$R_{gon} =$	16	Ω

Figure 16 Output inverter FRED

Typical reverse recovery current as a function of IGBT turn on gate resistor

$$I_{RRM} = f(R_{gon})$$

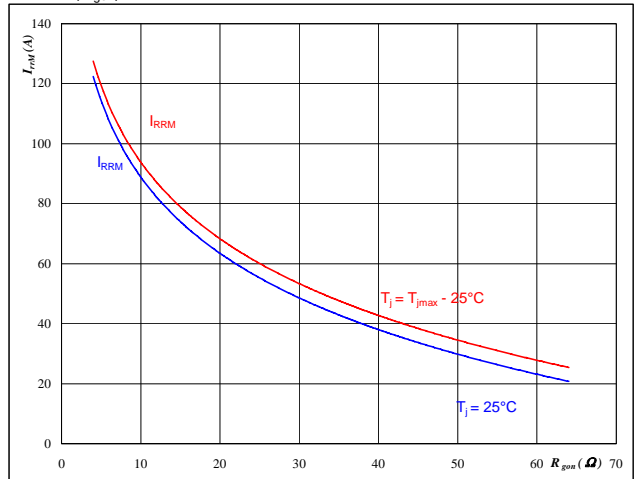

At

$T_j =$	25/150	°C
$V_R =$	600	V
$I_F =$	35	A
$V_{GE} =$	±15	V

Output Inverter

Figure 17 Output inverter FRED

Typical rate of fall of forward and reverse recovery current as a function of collector current

$$di_o/dt, di_{rec}/dt = f(I_c)$$

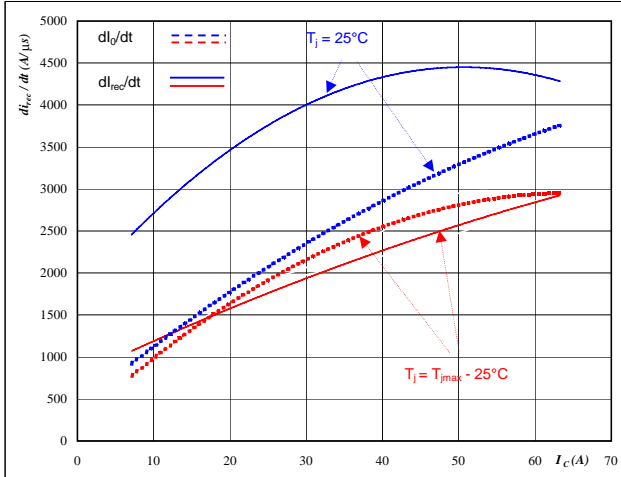

At

$T_j =$	25/150	°C
$V_{CE} =$	600	V
$V_{GE} =$	±15	V
$R_{gon} =$	16	Ω

Figure 18 Output inverter FRED

Typical rate of fall of forward and reverse recovery current as a function of IGBT turn on gate resistor

$$di_o/dt, di_{rec}/dt = f(R_{gon})$$

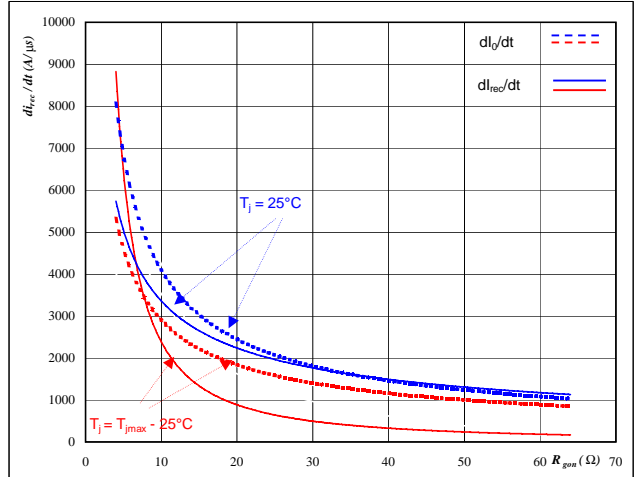

At

$T_j =$	25/150	°C
$V_R =$	600	V
$I_F =$	35	A
$V_{GE} =$	±15	V

Figure 19 Output inverter IGBT

IGBT transient thermal impedance as a function of pulse width

$$Z_{thJH} = f(t_p)$$

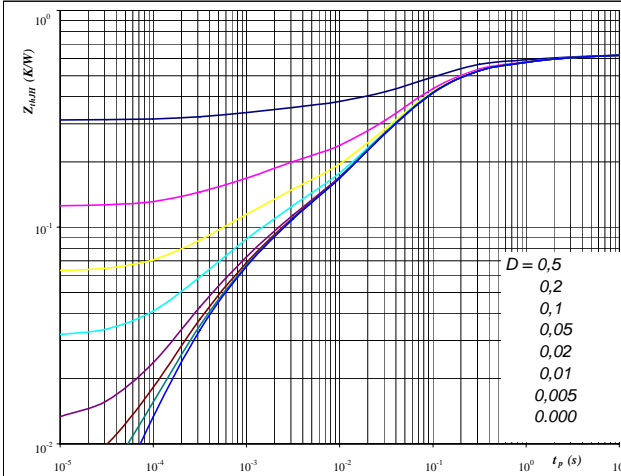

At

$D =$	t_p / T	
$R_{thJH} =$	0.62	K/W

IGBT thermal model values

R (C/W)	Tau (s)
0.04	3.6E+00
0.09	5.8E-01
0.31	8.1E-02
0.09	1.7E-02
0.06	1.6E-03
0.03	2.8E-04

Figure 20 Output inverter FRED

FRED transient thermal impedance as a function of pulse width

$$Z_{thJH} = f(t_p)$$

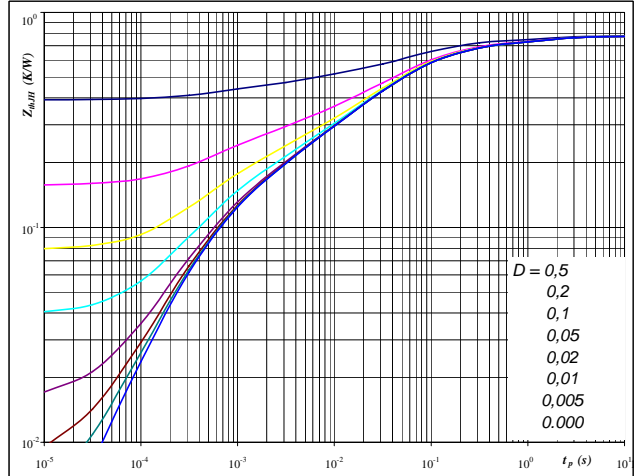

At

$D =$	t_p / T	
$R_{thJH} =$	0.78	K/W

FRED thermal model values

R (C/W)	Tau (s)
0.02	9.7E+00
0.09	9.8E-01
0.24	1.0E-01
0.22	2.5E-02
0.11	2.9E-03
0.09	4.1E-04

Output Inverter

Figure 21 Output inverter IGBT

Power dissipation as a function of heatsink temperature

$$P_{tot} = f(T_h)$$

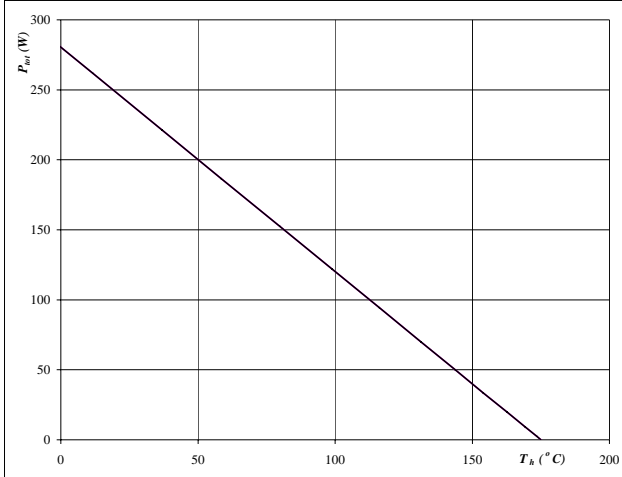

At $T_j = 175$ °C

— single heating
 — overall heating

Figure 22 Output inverter IGBT

Collector current as a function of heatsink temperature

$$I_C = f(T_h)$$

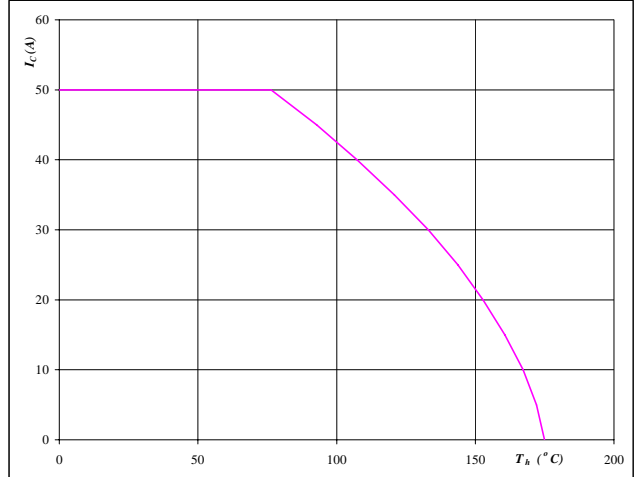

At $T_j = 175$ °C
 $V_{GE} = 15$ V

Figure 23 Output inverter FRED

Power dissipation as a function of heatsink temperature

$$P_{tot} = f(T_h)$$

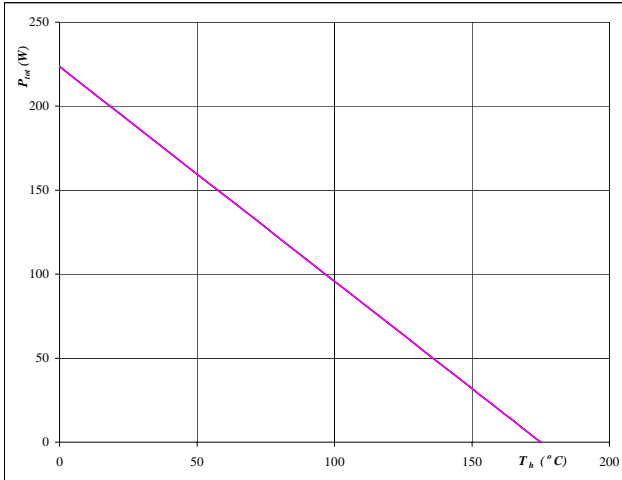

At $T_j = 175$ °C

— single heating
 — overall heating

Figure 24 Output inverter FRED

Forward current as a function of heatsink temperature

$$I_F = f(T_h)$$

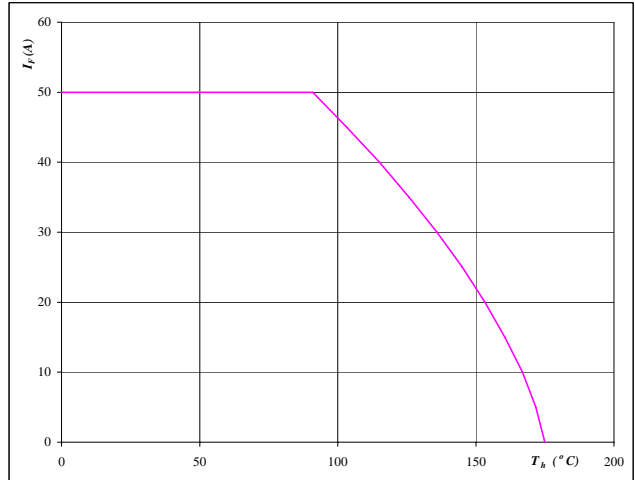

At $T_j = 175$ °C

Output Inverter

Figure 25 Output inverter IGBT

Safe operating area as a function of collector-emitter voltage

$$I_C = f(V_{CE})$$

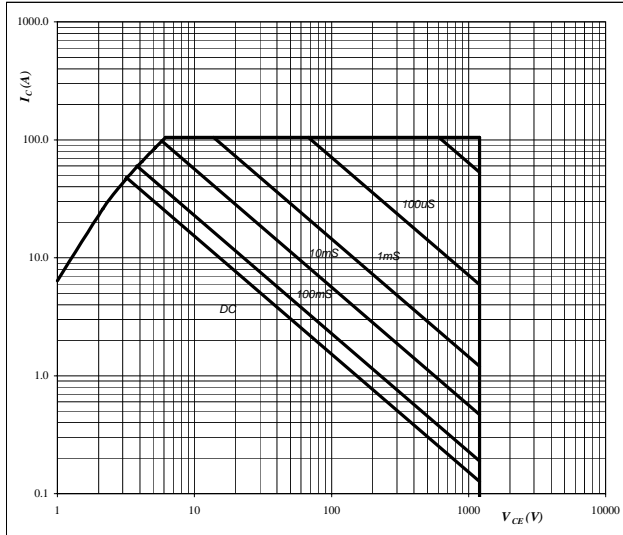

At
 D = single pulse
 Th = 80 °C
 V_{GE} = ±15 V
 T_j = T_{jmax} °C

Figure 26 Output inverter IGBT

Gate voltage vs Gate charge

$$V_{GE} = f(Q_g)$$

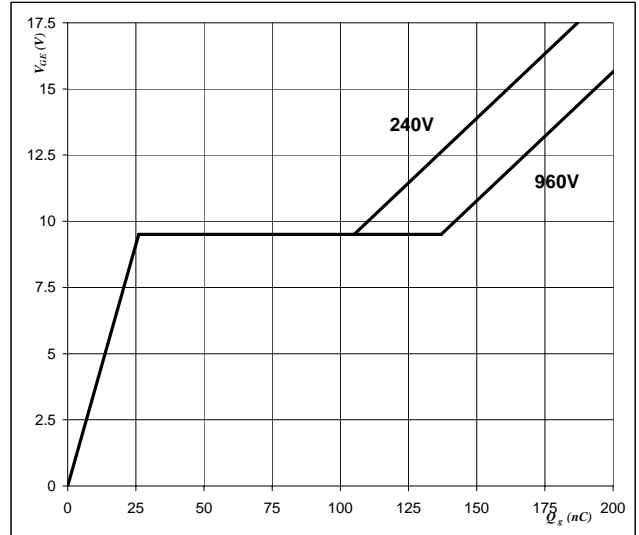

At
 I_C = 35 A

Brake

Figure 1 Brake IGBT

Typical output characteristics

$I_C = f(V_{CE})$



At
 $t_p = 250 \mu s$
 $T_j = 25 \text{ } ^\circ C$
 V_{GE} from 7 V to 17 V in steps of 1 V

Figure 2 Brake IGBT

Typical output characteristics

$I_C = f(V_{CE})$

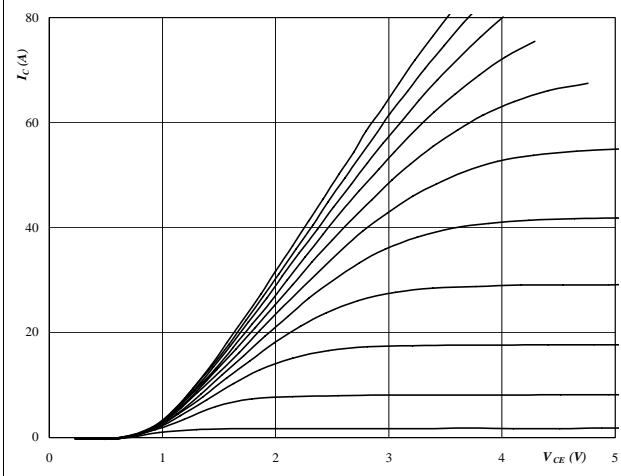

At
 $t_p = 250 \mu s$
 $T_j = 150 \text{ } ^\circ C$
 V_{GE} from 7 V to 17 V in steps of 1 V

Figure 3 Brake IGBT

Typical transfer characteristics

$I_C = f(V_{GE})$

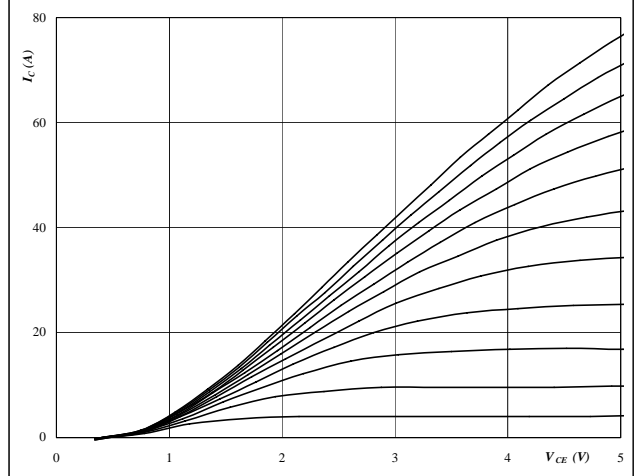
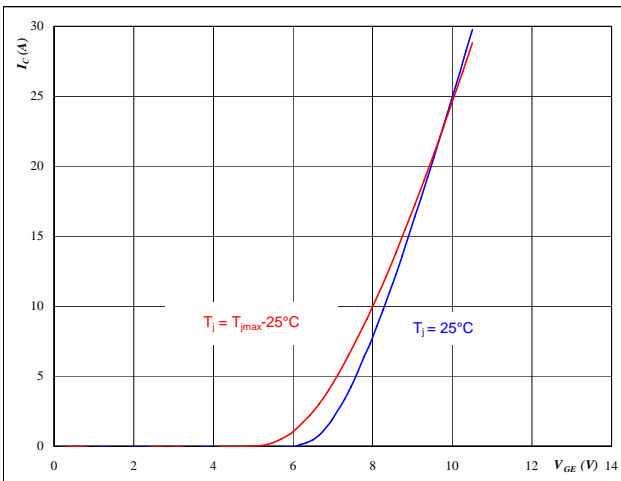
At
 $t_p = 250 \mu s$
 $V_{CE} = 10 \text{ V}$
Figure 4 Brake FRED

Typical diode forward current as a function of forward voltage

$I_F = f(V_F)$

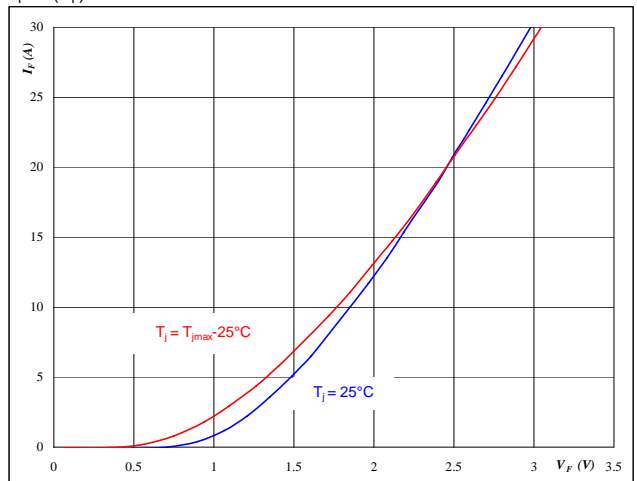

At
 $t_p = 250 \mu s$

Brake

Figure 5 Brake IGBT

Typical switching energy losses
 as a function of collector current

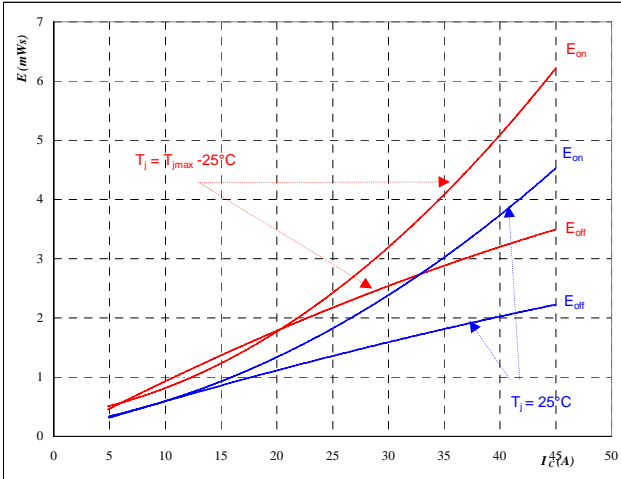
$$E = f(I_C)$$



With an inductive load at

$T_j =$	25/150	°C
$V_{CE} =$	600	V
$V_{GE} =$	±15	V
$R_{gon} =$	32	Ω
$R_{goff} =$	32	Ω

Figure 6 Brake IGBT

Typical switching energy losses
 as a function of gate resistor

$$E = f(R_G)$$

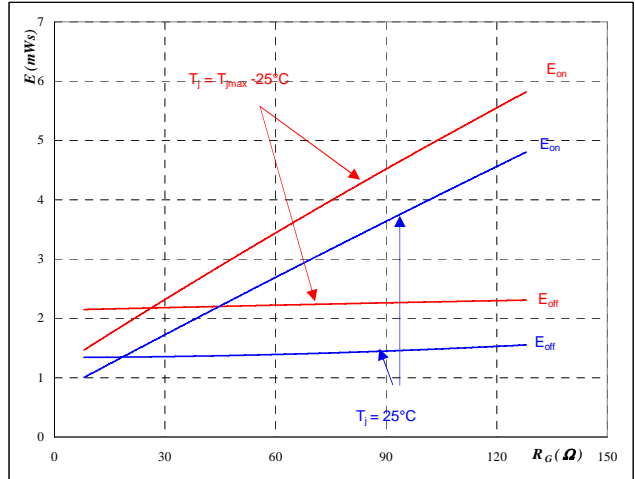

With an inductive load at

$T_j =$	25/150	°C
$V_{CE} =$	600	V
$V_{GE} =$	±15	V
$I_C =$	25	A

Figure 7 Brake IGBT

Typical reverse recovery energy loss
 as a function of collector current

$$E_{rec} = f(I_C)$$

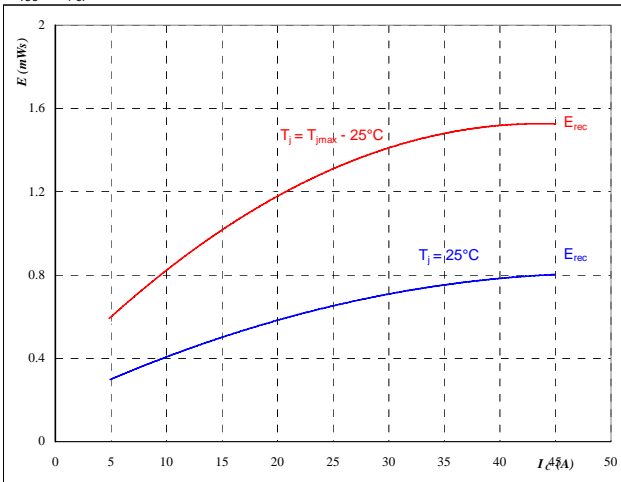

With an inductive load at

$T_j =$	25/150	°C
$V_{CE} =$	600	V
$V_{GE} =$	±15	V
$R_{gon} =$	32	Ω

Figure 8 Brake IGBT

Typical reverse recovery energy loss
 as a function of gate resistor

$$E_{rec} = f(R_G)$$

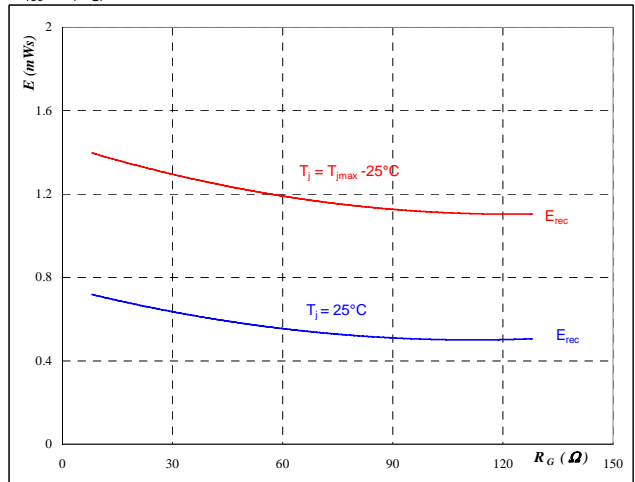

With an inductive load at

$T_j =$	25/150	°C
$V_{CE} =$	600	V
$V_{GE} =$	±15	V
$I_C =$	25	A

Brake

Figure 9 Brake IGBT

Typical switching times as a function of collector current

$$t = f(I_C)$$

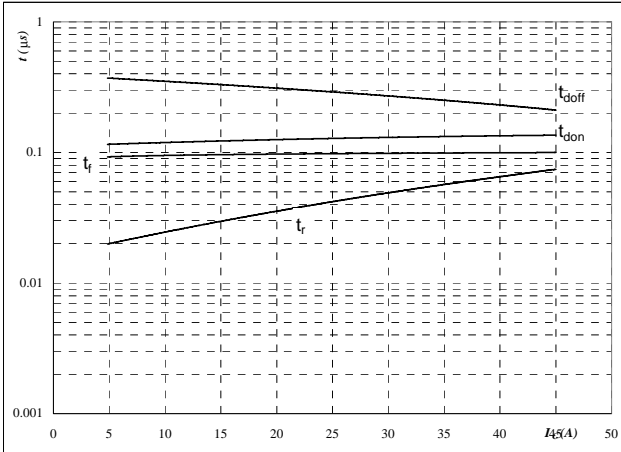

With an inductive load at

$T_j =$	25/150	°C
$V_{CE} =$	600	V
$V_{GE} =$	±15	V
$R_{gon} =$	32	Ω
$R_{goff} =$	32	Ω

Figure 10 Brake IGBT

Typical switching times as a function of gate resistor

$$t = f(R_G)$$

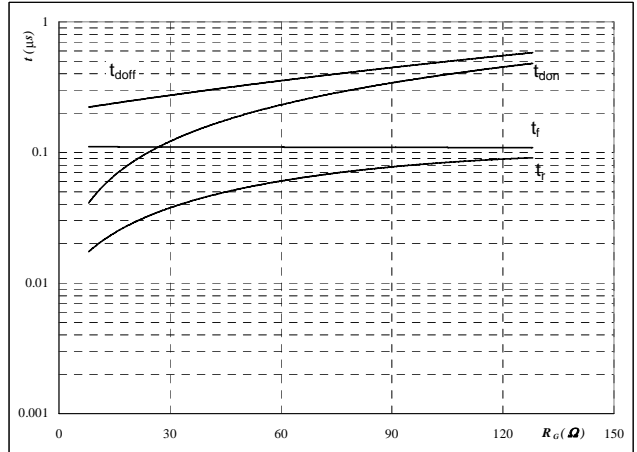

With an inductive load at

$T_j =$	25/150	°C
$V_{CE} =$	600	V
$V_{GE} =$	±15	V
$I_C =$	25	A

Figure 11 Brake IGBT

IGBT transient thermal impedance as a function of pulse width

$$Z_{thJH} = f(t_p)$$

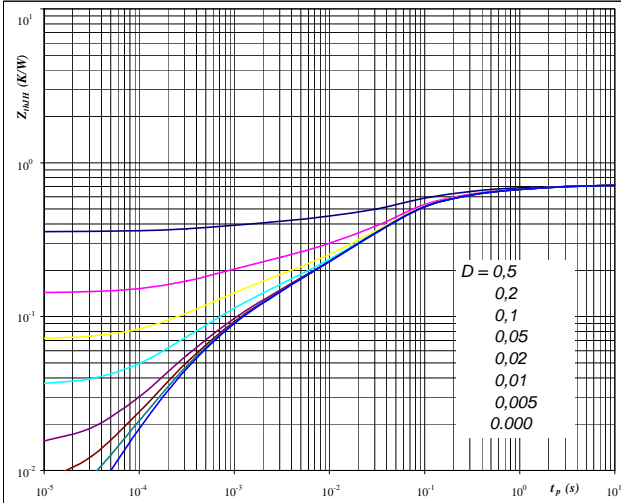

At

$D =$	t_p / T	
$R_{thJH} =$	0.71	K/W

Figure 12 Brake FRED

FRED transient thermal impedance as a function of pulse width

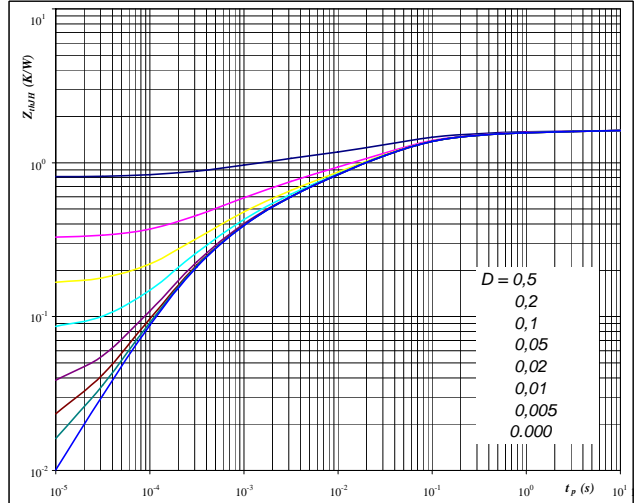
$$Z_{thJH} = f(t_p)$$

At

$D =$	t_p / T	
$R_{thJH} =$	1.62	K/W

Brake

Figure 13 Brake IGBT

Power dissipation as a function of heatsink temperature

$$P_{tot} = f(T_h)$$



At
 $T_j = 175$ °C

Figure 14 Brake IGBT

Collector current as a function of heatsink temperature

$$I_C = f(T_h)$$

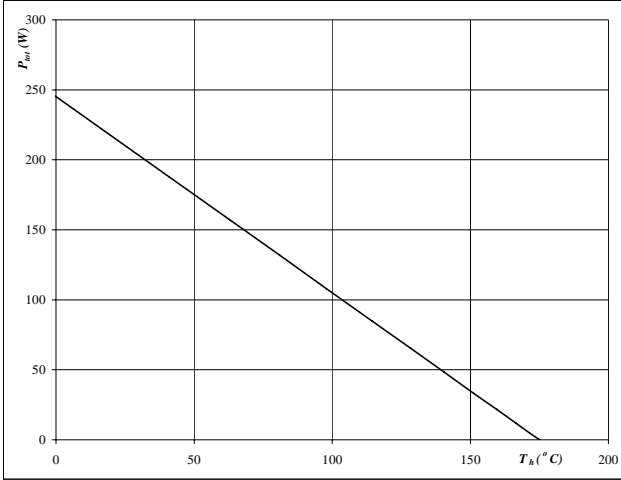

At
 $T_j = 175$ °C
 $V_{GE} = 15$ V

Figure 15 Brake FRED

Power dissipation as a function of heatsink temperature

$$P_{tot} = f(T_h)$$

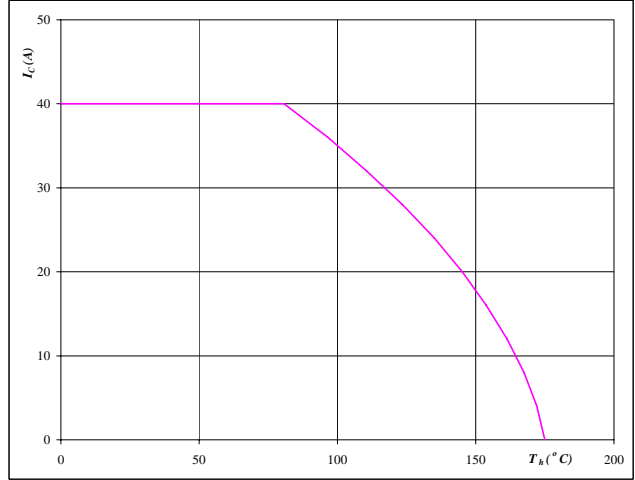

At
 $T_j = 175$ °C

Figure 16 Brake FRED

Forward current as a function of heatsink temperature

$$I_F = f(T_h)$$

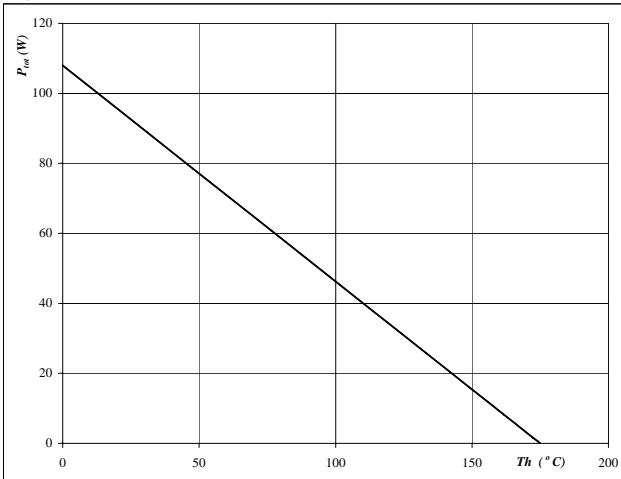
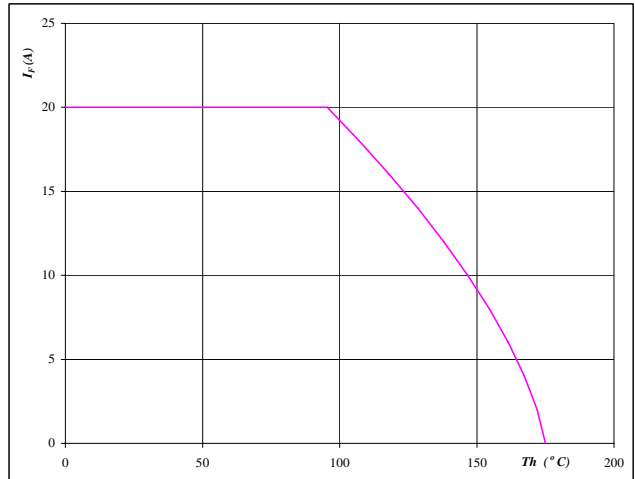

At
 $T_j = 175$ °C

Input Rectifier Bridge

Figure 1 Rectifier diode

Typical diode forward current as a function of forward voltage

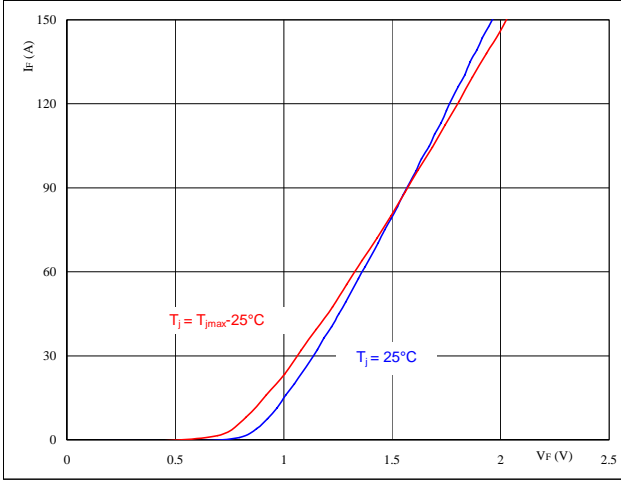
$$I_F = f(V_F)$$

At
 $t_p = 250 \mu s$
Figure 2 Rectifier diode

Diode transient thermal impedance as a function of pulse width

$$Z_{thJH} = f(t_p)$$

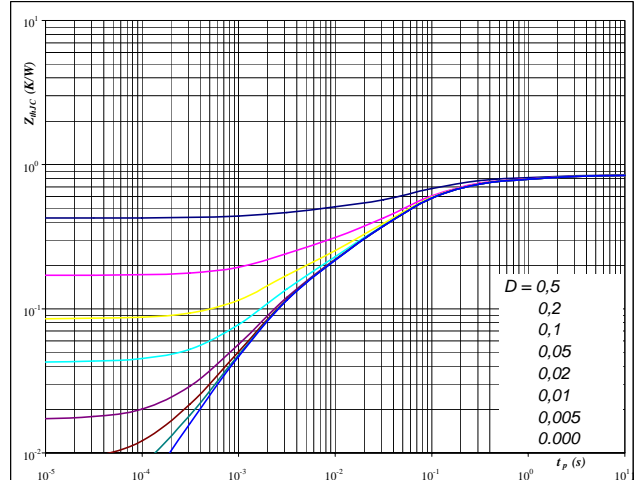
At
 $D = t_p / T$
 $R_{thJH} = 0.851 \text{ K/W}$
Figure 3 Rectifier diode

Power dissipation as a function of heatsink temperature

$$P_{tot} = f(T_h)$$

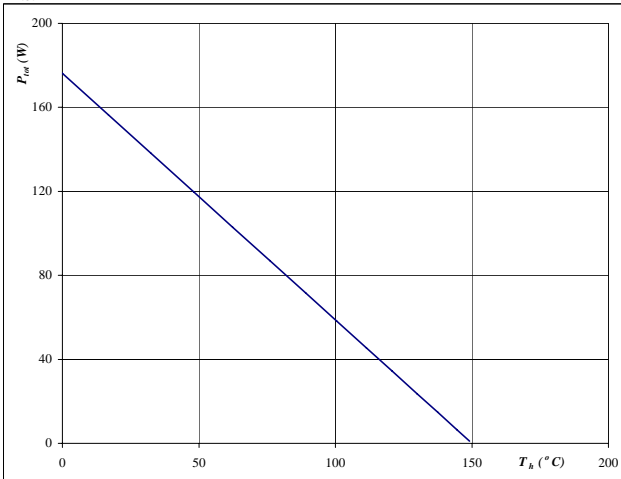
At
 $T_j = 150 \text{ }^\circ\text{C}$
Figure 4 Rectifier diode

Forward current as a function of heatsink temperature

$$I_F = f(T_h)$$

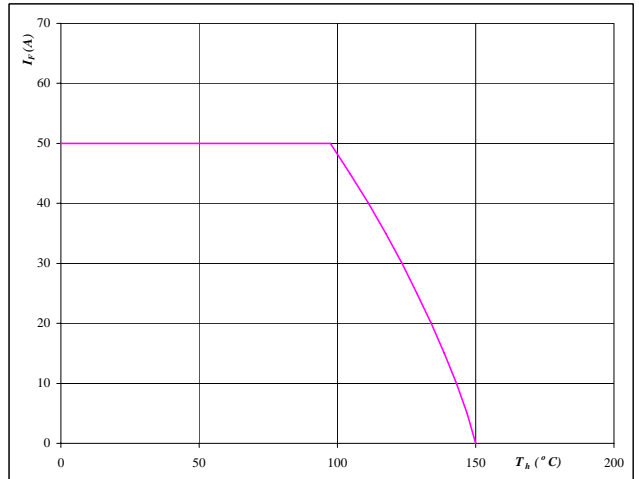

At
 $T_j = 150 \text{ }^\circ\text{C}$

Thermistor

Figure 1 Thermistor

**Typical NTC characteristic
as a function of temperature**

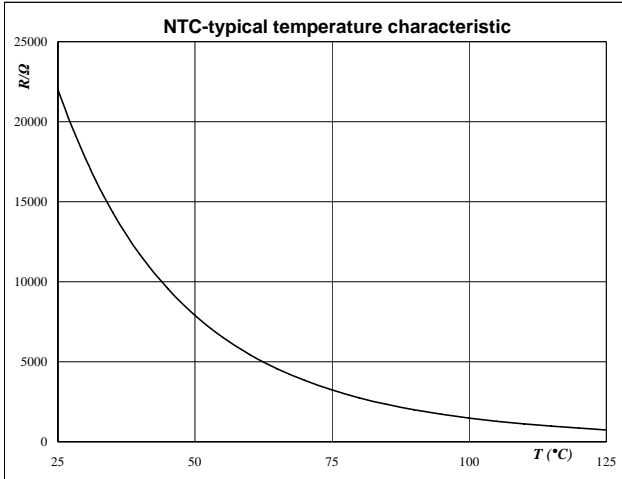
$R_T = f(T)$



Switching Definitions Output Inverter

General conditions

T_j	=	150 °C
R_{gon}	=	16 Ω
R_{goff}	=	16 Ω

Figure 1 Output inverter IGBT

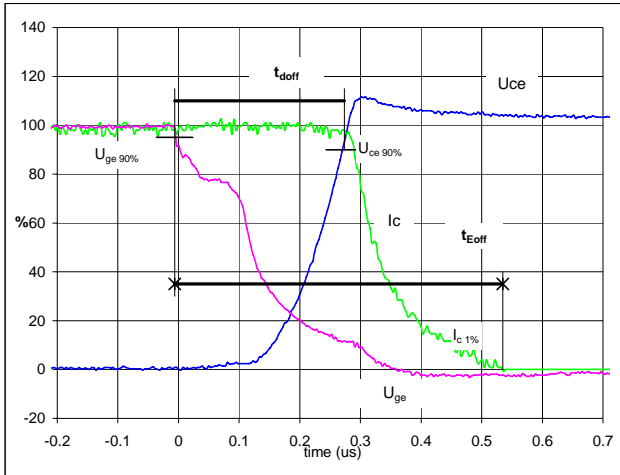
Turn-off Switching Waveforms & definition of t_{doff} , t_{Eoff}
 (t_{Eoff} = integrating time for E_{off})

V_{GE} (0%) =	-15	V
V_{GE} (100%) =	15	V
V_C (100%) =	600	V
I_C (100%) =	35	A
t_{doff} =	0.27	μ s
t_{Eoff} =	0.54	μ s

Figure 2 Output inverter IGBT

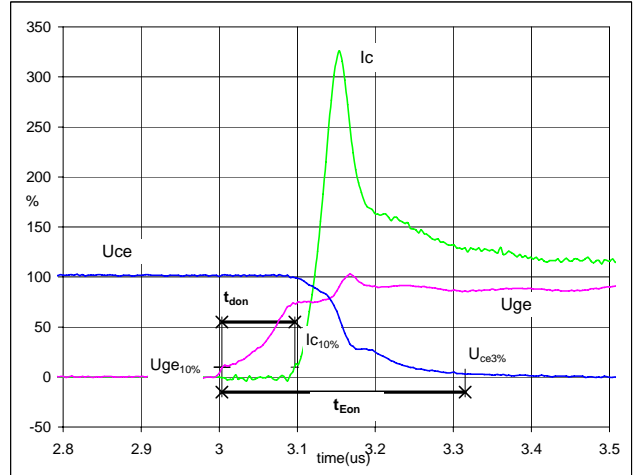
Turn-on Switching Waveforms & definition of t_{don} , t_{Eon}
 (t_{Eon} = integrating time for E_{on})

V_{GE} (0%) =	-15	V
V_{GE} (100%) =	15	V
V_C (100%) =	600	V
I_C (100%) =	35	A
t_{don} =	0.09	μ s
t_{Eon} =	0.31	μ s

Figure 3 Output inverter IGBT

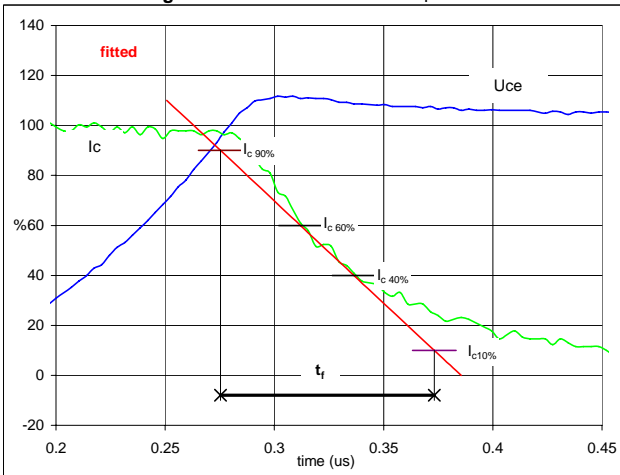
Turn-off Switching Waveforms & definition of t_f

V_C (100%) =	600	V
I_C (100%) =	35	A
t_f =	0.11	μ s

Figure 4 Output inverter IGBT

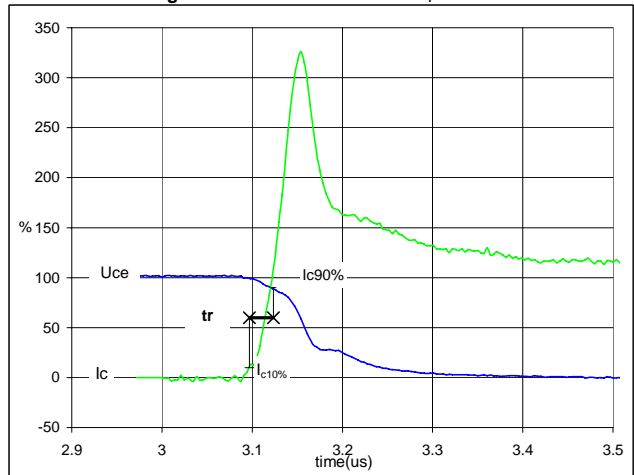
Turn-on Switching Waveforms & definition of t_r

V_C (100%) =	600	V
I_C (100%) =	35	A
t_r =	0.02	μ s

Switching Definitions Output Inverter

Figure 5 Output inverter IGBT

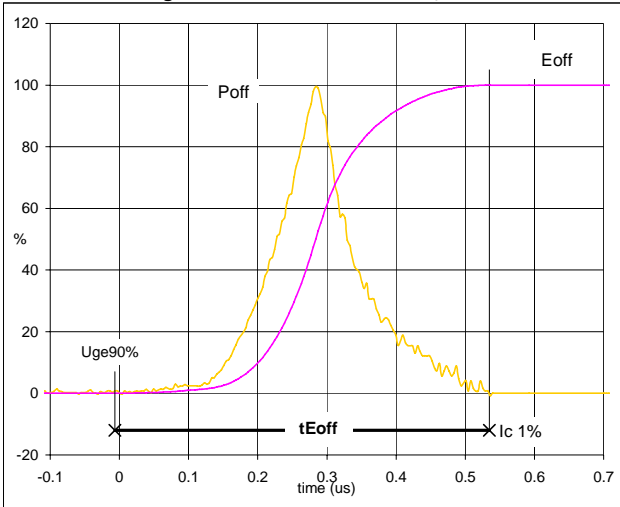
Turn-off Switching Waveforms & definition of t_{Eoff}

$P_{off}(100\%) = 21.01$ kW
 $E_{off}(100\%) = 2.82$ mJ
 $t_{Eoff} = 0.54$ μ s

Figure 6 Output inverter IGBT

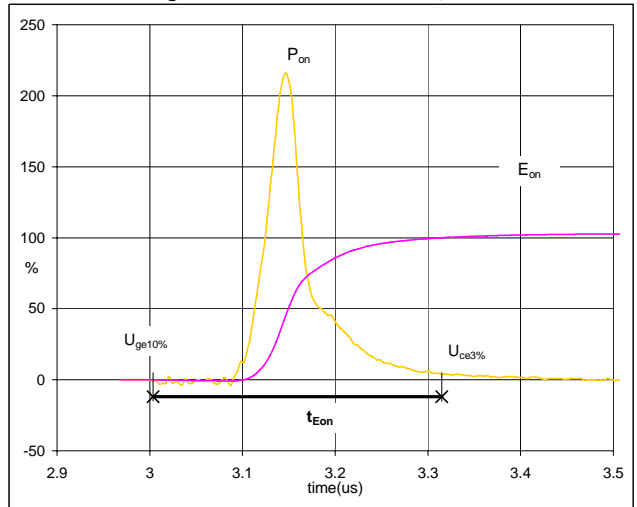
Turn-on Switching Waveforms & definition of t_{Eon}

$P_{on}(100\%) = 21.01$ kW
 $E_{on}(100\%) = 2.49$ mJ
 $t_{Eon} = 0.31$ μ s

Figure 7 Output inverter FRED

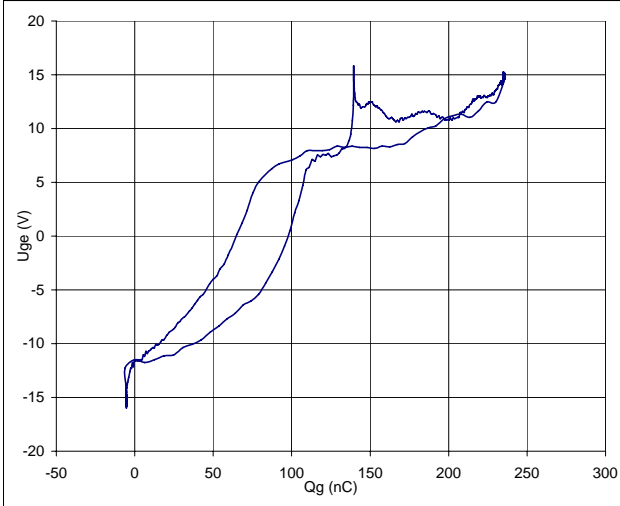
Gate voltage vs Gate charge (measured)

$V_{GEoff} = -15$ V
 $V_{GEon} = 15$ V
 $V_C(100\%) = 600$ V
 $I_C(100\%) = 35$ A
 $Q_g = 1239.53$ nC

Figure 8 Output inverter IGBT

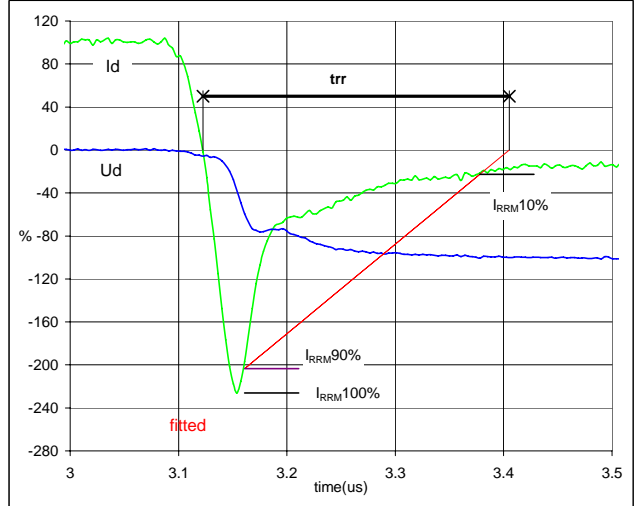
Turn-off Switching Waveforms & definition of t_{rr}

$V_d(100\%) = 600$ V
 $I_d(100\%) = 35$ A
 $I_{RRM}(100\%) = -79$ A
 $t_{rr} = 0.28$ μ s

Switching Definitions Output Inverter

Figure 9 Output inverter FRED

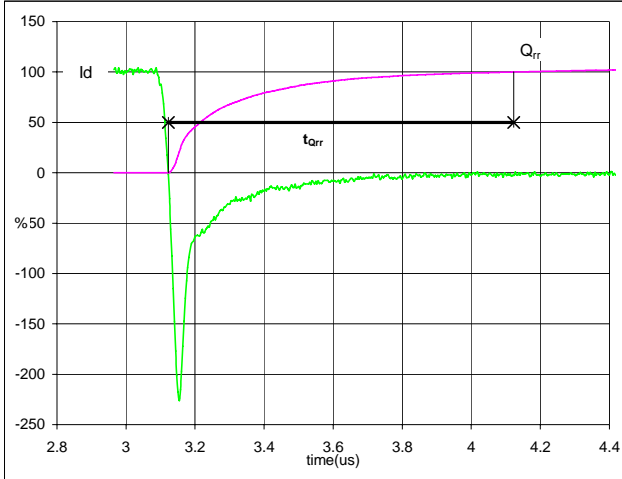
Turn-on Switching Waveforms & definition of t_{Qrr}
 (t_{Qrr} = integrating time for Q_{rr})

I_d (100%) =	35	A
Q_{rr} (100%) =	7.47	μC
t_{Qrr} =	1.00	μs

Figure 10 Output inverter FRED

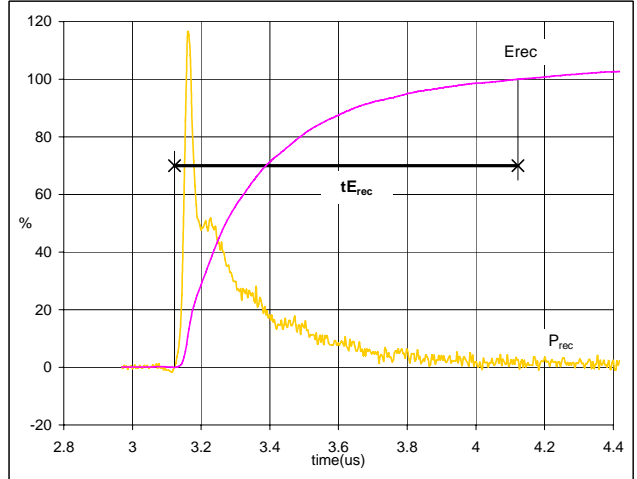
Turn-on Switching Waveforms & definition of t_{Erec}
 (t_{Erec} = integrating time for E_{rec})

P_{rec} (100%) =	21.01	kW
E_{rec} (100%) =	3.31	mJ
t_{Erec} =	1.00	μs

General conditions

3phase SPWM

V_{GEon}	=	15 V
V_{GEoff}	=	-15 V
R_{gon}	=	16 Ω
R_{goff}	=	16 Ω

Figure 1 IGBT

Typical average static loss as a function of output current

$P_{loss} = f(I_{out})$

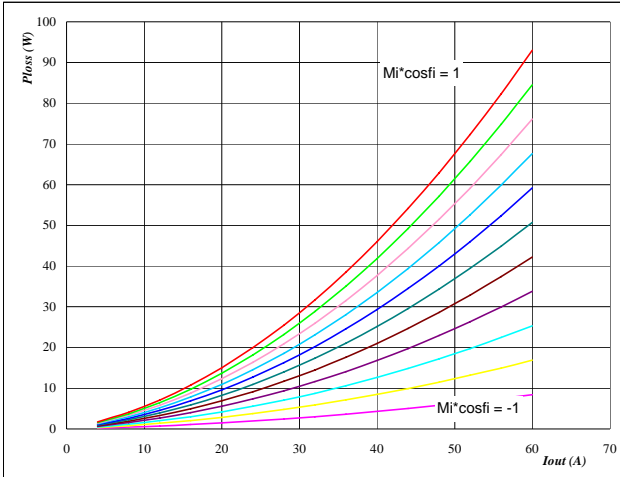

At
 $T_j = 150 \text{ }^\circ\text{C}$
 $M_i \cdot \cos\phi$ from -1 to 1 in steps of 0.2

Figure 2 FRED

Typical average static loss as a function of output current

$P_{loss} = f(I_{out})$

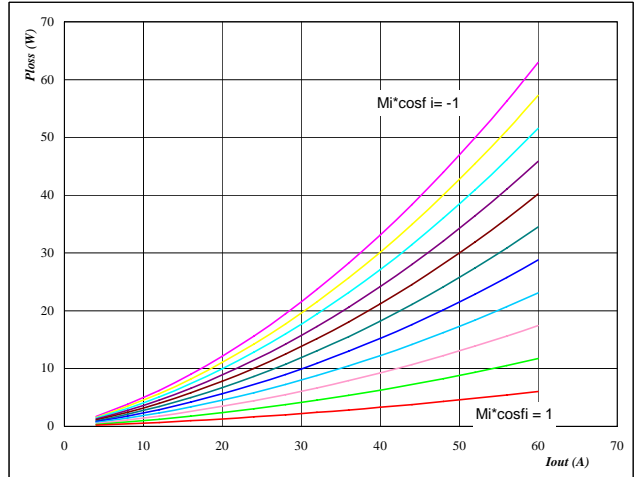

At
 $T_j = 150 \text{ }^\circ\text{C}$
 $M_i \cdot \cos\phi$ from -1 to 1 in steps of 0.2

Figure 3 IGBT

Typical average switching loss as a function of output current

$P_{loss} = f(I_{out})$

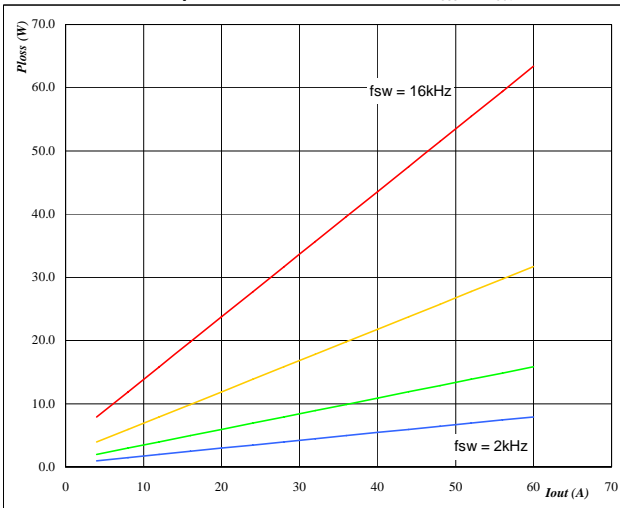

At
 $T_j = 150 \text{ }^\circ\text{C}$
 DC link = 600 V
 f_{sw} from 2 kHz to 16 kHz in steps of factor 2

Figure 4 FRED

Typical average switching loss as a function of output current

$P_{loss} = f(I_{out})$

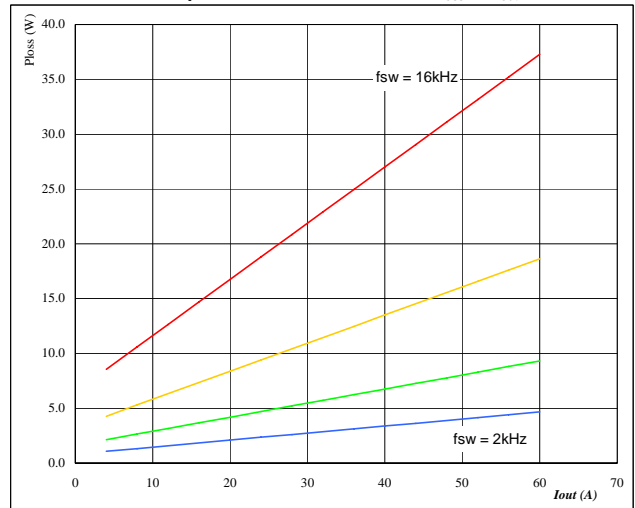

At
 $T_j = 150 \text{ }^\circ\text{C}$
 DC link = 600 V
 f_{sw} from 2 kHz to 16 kHz in steps of factor 2

Figure 5 Phase

Typical available 50Hz output current as a function $Mi \cdot \cos \varphi$

$$I_{out} = f(Mi \cdot \cos \varphi)$$

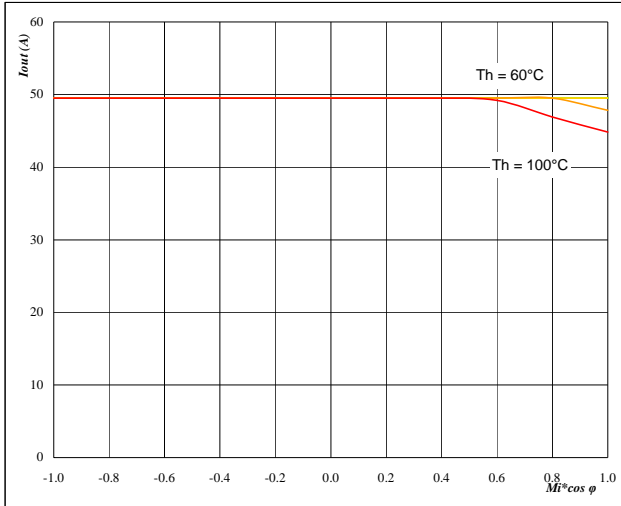

At
 $T_j = 150 \text{ } ^\circ\text{C}$
 DC link = 600 V
 $f_{sw} = 8 \text{ kHz}$
 T_h from 60 °C to 100 °C in steps of 5 °C

Figure 6 Phase

Typical available 50Hz output current as a function of switching frequency

$$I_{out} = f(f_{sw})$$

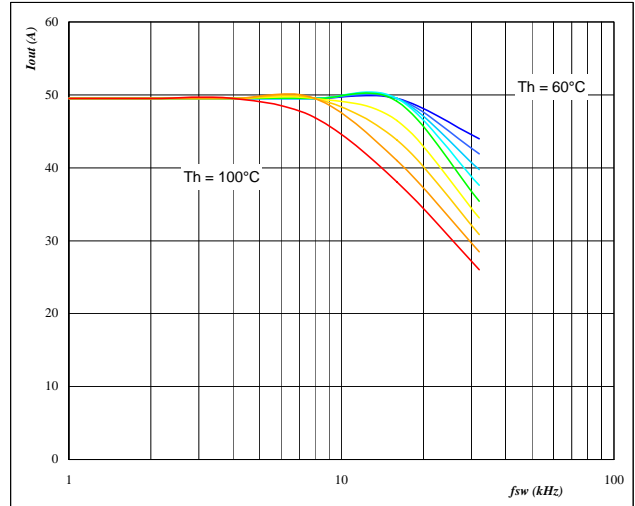

At
 $T_j = 150 \text{ } ^\circ\text{C}$
 DC link = 600 V
 $Mi \cdot \cos \varphi = 0.8$
 T_h from 60 °C to 100 °C in steps of 5 °C

Figure 7 Phase

Typical available 50Hz output current as a function of $Mi \cdot \cos \varphi$ and switching frequency

$$I_{out} = f(f_{sw}, Mi \cdot \cos \varphi)$$

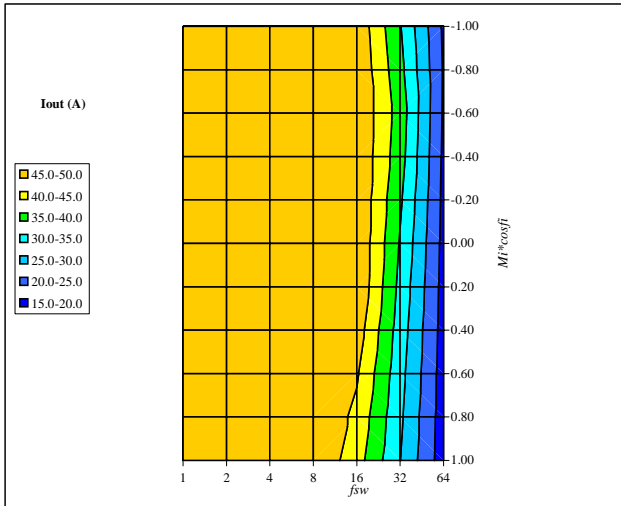

At
 $T_j = 150 \text{ } ^\circ\text{C}$
 DC link = 600 V
 $T_h = 90 \text{ } ^\circ\text{C}$

Figure 8 Phase

Typical available 0Hz output current as a function of switching frequency

$$I_{outpeak} = f(f_{sw})$$

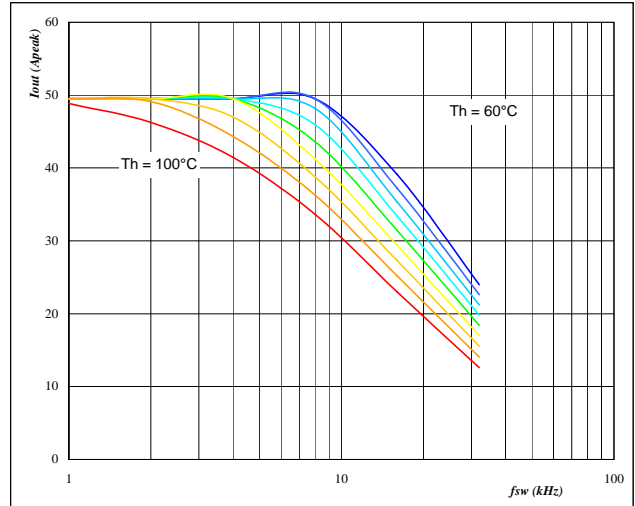

At
 $T_j = 150 \text{ } ^\circ\text{C}$
 DC link = 600 V
 T_h from 60 °C to 100 °C in steps of 5 °C
 $Mi = 0$

Figure 9 Inverter

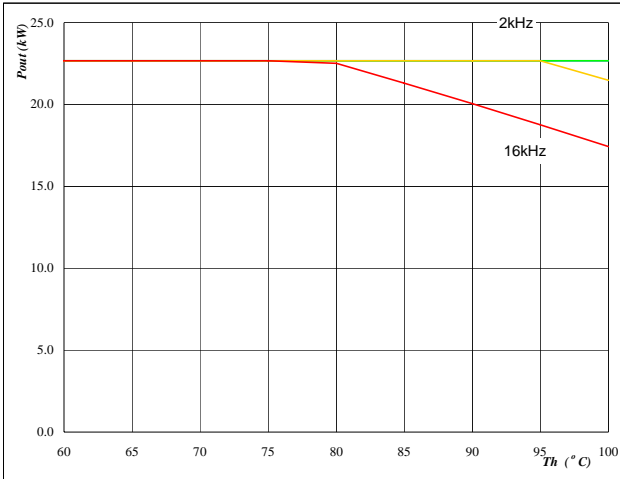
Typical available peak output power as a function of heatsink temperature
 $P_{out}=f(T_h)$

At
 $T_j = 150 \text{ } ^\circ\text{C}$
 DC link = 600 V
 $M_i = 1$
 $\cos \varphi = 0.80$
 f_{sw} from 2 kHz to 16 kHz in steps of factor 2

Figure 10 Inverter

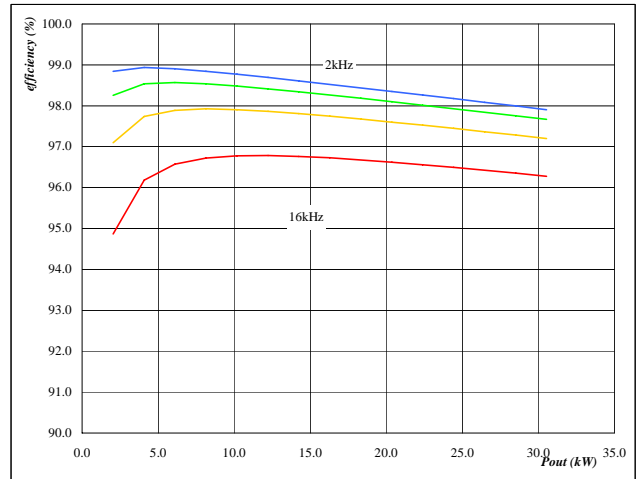
Typical efficiency as a function of output power
 $\text{efficiency}=f(P_{out})$

At
 $T_j = 150 \text{ } ^\circ\text{C}$
 DC link = 600 V
 $M_i = 1$
 $\cos \varphi = 0.80$
 f_{sw} from 2 kHz to 16 kHz in steps of factor 2

Figure 11 Inverter

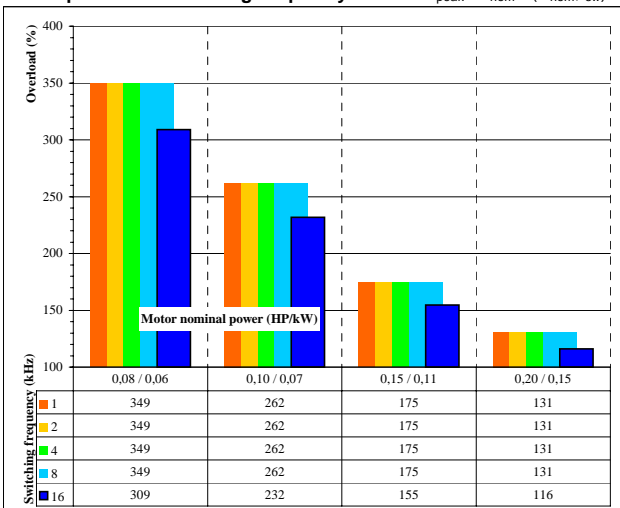
Typical available overload factor as a function of motor power and switching frequency
 $P_{peak} / P_{nom}=f(P_{nom}, f_{sw})$

At
 $T_j = 150 \text{ } ^\circ\text{C}$
 DC link = 600 V
 $M_i = 1$
 $\cos \varphi = 0.8$
 f_{sw} from 1 kHz to 16kHz in steps of factor 2
 $T_h = 90 \text{ } ^\circ\text{C}$
 Motor eff = 0.85

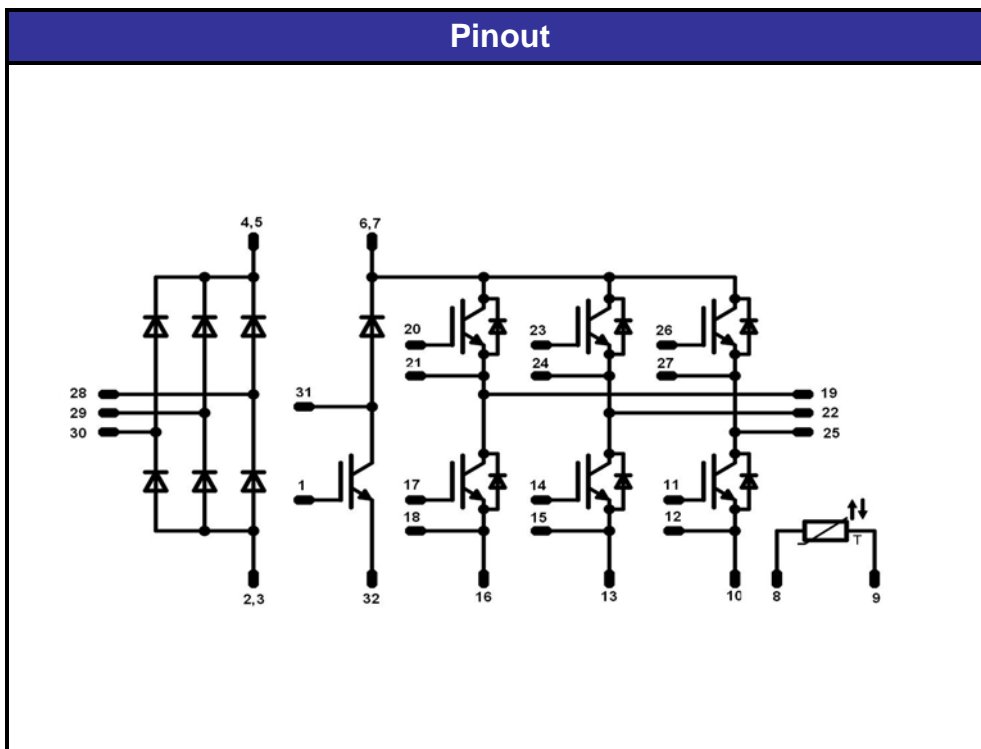
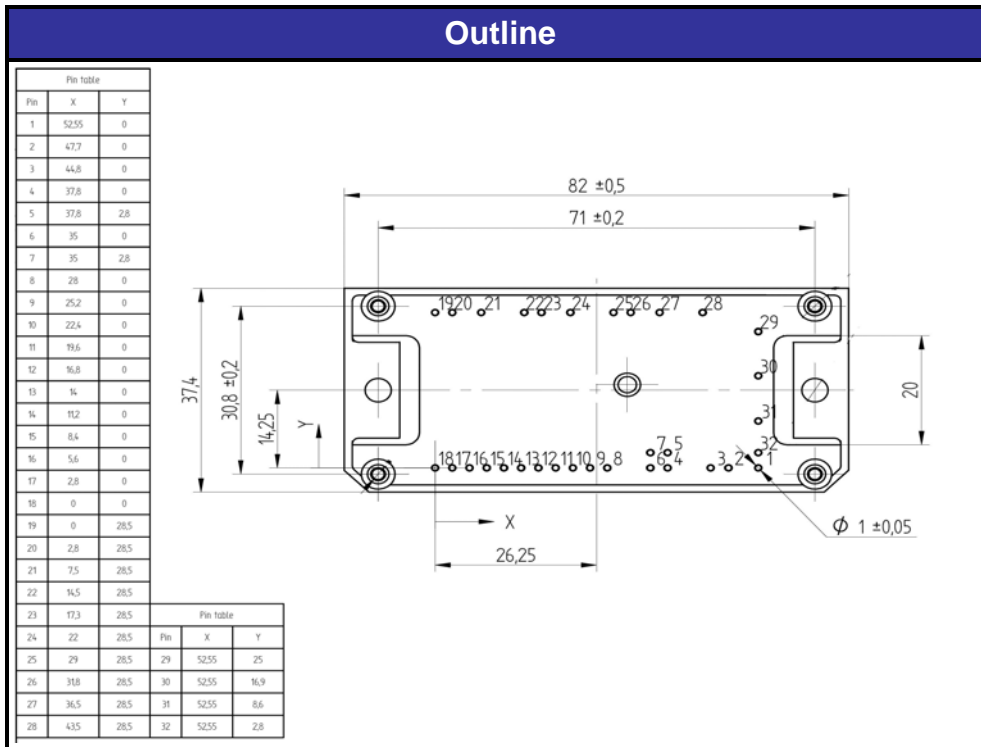
Package Outline and Pinout

PRODUCT STATUS DEFINITIONS

Datasheet Status	Product Status	Definition
Target	Formative or In Design	This datasheet contains the design specifications for product development. Specifications may change in any manner without notice. The data contained is exclusively intended for technically trained staff.
Preliminary	First Production	This datasheet contains preliminary data, and supplementary data may be published at a later date. Vincotech reserves the right to make changes at any time without notice in order to improve design. The data contained is exclusively intended for technically trained staff.
Final	Full Production	This datasheet contains final specifications. Vincotech reserves the right to make changes at any time without notice in order to improve design. The data contained is exclusively intended for technically trained staff.

DISCLAIMER

The information given in this datasheet describes the type of component and does not represent assured characteristics. For tested values please contact Vincotech. Vincotech reserves the right to make changes without further notice to any products herein to improve reliability, function or design. Vincotech does not assume any liability arising out of the application or use of any product or circuit described herein; neither does it convey any license under its patent rights, nor the rights of others.

LIFE SUPPORT POLICY

Vincotech products are not authorised for use as critical components in life support devices or systems without the express written approval of Vincotech.

As used herein:

1. Life support devices or systems are devices or systems which, (a) are intended for surgical implant into the body, or (b) support or sustain life, or (c) whose failure to perform when properly used in accordance with instructions for use provided in labelling can be reasonably expected to result in significant injury to the user.
2. A critical component is any component of a life support device or system whose failure to perform can be reasonably expected to cause the failure of the life support device or system, or to affect its safety or effectiveness.