

Features

Regulated Converters

- Universal Input 80-264VAC
- High efficiency up to 77%
- Isolated Output 3kVAC / 1 min
- Short Circuit Protection
- Meet EN55022 Class B
- Low Standby Power Consumption

Description

Compact, low cost, high efficiency, universal input switching AC/DC power module for PCB or wired mounting with single or dual outputs. CE marked and UL/cUL certified.

Selection Guide

Part Number	Input Voltage (VAC)	Output Voltage (VDC)	Output Current (max.)	Efficiency (Typ.)	Max. Capacitive Load ⁽¹⁺²⁾
RAC05-3.3SC*	80-264	3.3	1250	70	12000µF
RAC05-05SC*	80-264	5	1000	73	6800µF
RAC05-09SC*	80-264	9	556	75	2500µF
RAC05-12SC*	80-264	12	420	76	1500µF
RAC05-15SC*	80-264	15	340	76	750µF
RAC05-24SC*	80-264	24	210	77	330µF
RAC05-05DC*	80-264	±5	±500	73	±3000µF
RAC05-12DC*	80-264	±12	±210	76	±560µF
RAC05-15DC*	80-264	±15	±170	76	±220µF

* add suffix /W for wired version

Specifications (measured at TA 25°C, full load after warm-up)

Input Voltage Range (with derating)	80-264VAC or 115-370VDC	
Rated Power	5 Watts max.	
Input Frequency (for AC Input)	47-440Hz	
Input Current (Full Load)	115VAC / 230VAC	110mA / 70mA typ.
Inrush Current (<2ms)	115VAC / 230VAC	30A / 60A max.
Minimum Load (Specifications valid with 5% min.)	0%	
No Load Power Consumption	0.25W max.	
Recommended External Input Fuse	1.5A / Slow Blow Type	
Output Voltage Accuracy (Full Load)	115VAC / 230VAC	±2% max.
Line Voltage Regulation (Full Load)	LL-HL	±0.3% typ.
Load Voltage Regulation	5-100% Load	±0.5% typ.
Output Ripple&Noise @115/230VAC	3.3V	120mV max.
(20MHz limited with 100nF across output)	All Others	150mV max.
Switching Frequency (Full Load)	132kHz typ.	
Efficiency (Full Load)	see Selection Guide	
Hold-Up Time (Full Load)	115VAC	10ms typ.
Leakage Current	0.85mA max.	
Isolation Voltage	Input-Output	3kVAC / 1 minute
Isolation Capacitance	Input-Output	1000pF typ.
Isolation Resistance	Input-Output	1G Ω min.
Short Circuit Protection	Hiccup, Automatic Restart	
Overvoltage Protection (of Nominal Output Voltage)	3.3V	4.8 V- 5.4V
	All Others	110% - 135%
Over Voltage Category	OVC II	
Operating Temperature Range ⁽³⁾ (Natural Convection)	-25°C to +55°C (without Derating) -25°C to +75°C (with Derating)	
Storage Temperature Range	-40°C to +100°C	
Case Material	UL94V-0 Black Plastic	

continued on the next page

POWERLINE

AC/DC-Converter

with 3 year Warranty

RECOM

5 Watt Single / Dual Output

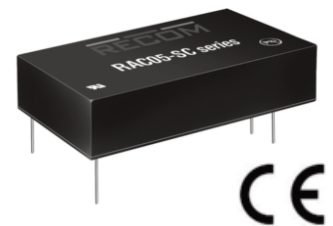

EN-60950-1 Certified
UL-60950-1 Certified

RAC05-C

Derating-Graph (Ambient Temperature)

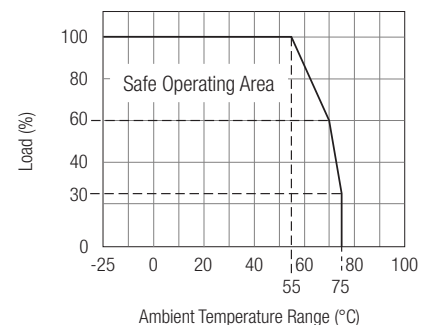

Refer to Application Notes

Specifications (measured at TA 25°C, full load after warm-up)

Potting Material		Epoxy UL94V-0
Relative Humidity		95% RH max.
Package Weight	Single / Dual	35g / 38g
Packing Quantity	Single Output	10pcs
	Dual Output	9pcs
	Wired Version	1pc
MTBF (25°C)	Using MIL-HDBK 217F	>400 x 10 ³ hours
	Using MIL-HDBK 217F	>200 x 10 ³ hours
Emissions	CE	EN 55022: 2006 + A1: 2007 / Class B
	EMC	EN 55024:1998 + A1:2001 + A2:2003
	Harmonics	EN 61000-3-2:2006 / Class A
	Flicker	EN 61000-3-3:1995 + A1:2001 + A2:2005
Immunity	ESD	IEC 61000-4-2 / Criterion B
	RS	IEC 61000-4-3 / Criterion A
	EFT	IEC 61000-4-4 / Criterion B
	Surge	IEC 61000-4-5 / Criterion B
	CS	IEC 61000-4-6 / Criterion A
	PMF	IEC 61000-4-8 / Criterion A
	Voltage Variations	IEC 61000-4-11 / Criteria B + C
Certifications:		
UL General Safety	Report: E224736	UL-60950-1, 2nd Edition
cUL	Report: E224736	C22.2 No. 60950-1-07, 2nd Edition
EN General Safety	Report: SPCLVD1211033-1	EN-60950-:2006 + A12:2011
CE		EN55022 Class B

Notes:

Note1: Measured @230VAC / 50Hz / Ta=25°C with constant resistant mode at full load.

Note2: If used @115VAC / 60Hz with full load, max. capacitive load is less, please contact RECOM for detailed information.

Note3: Start up only is guaranteed at temperatures down to -25°C. Other specifications may not be met.

Typical Characteristics

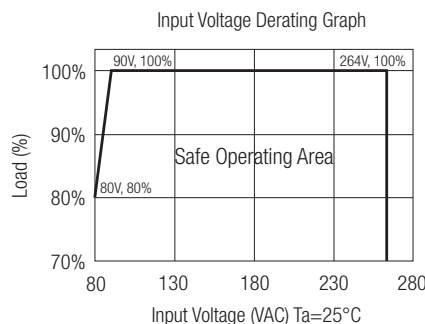
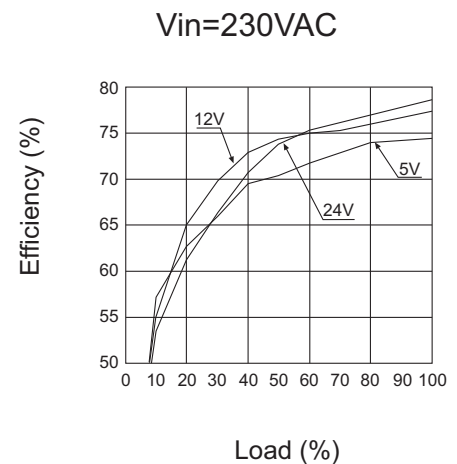
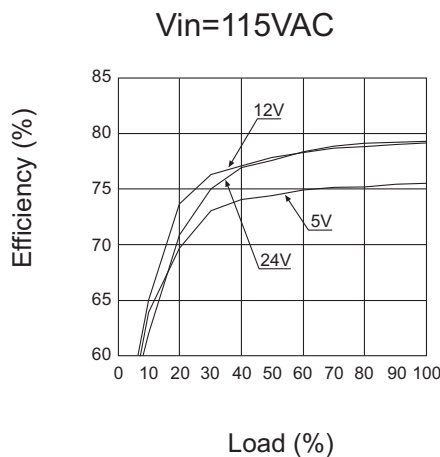

Package Style and Pinning

PCB Mout Version (Standard)

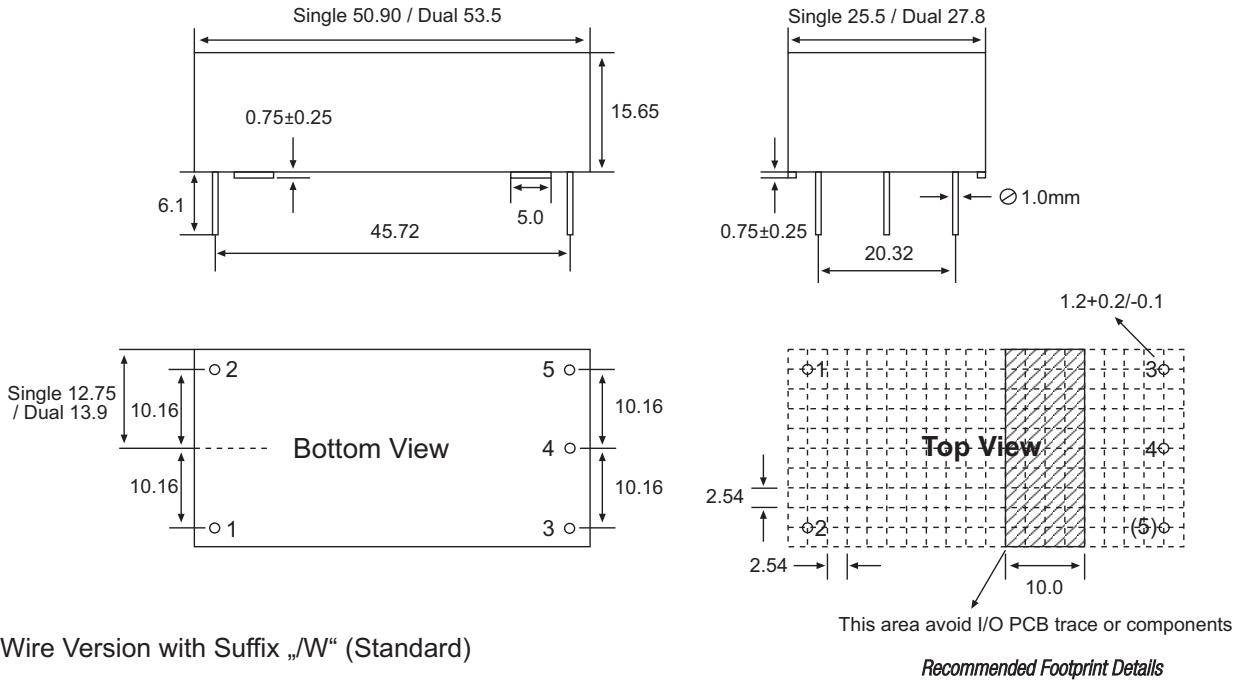

Wire Version with Suffix „W“ (Standard)

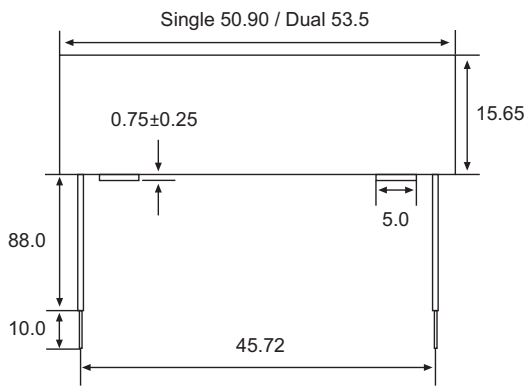

Pin Connections

Pin #	Single Out	Dual Out
1	VAC in (N)	VAC in (N)
2	VAC in (L)	VAC in (L)
3	+VDC out	+VDC out
4	-VDC out	Com
5	no Pin	-VDC out

NC = No Connection
xx.x = ±0.5mm
xx.xx = ±0.25mm

Wire Connections

Pin #			Single out	Dual out
1 (Blue)	AWG#22	1015	VAC in (N)	VAC in (N)
2 (Brown)	AWG#22	1015	VAC in (L)	VAC in (L)
3 (Red)	AWG#22	1007	+VDC out	+VDC out
4 (Black)	AWG#22	1007	-VDC out	Common
5 (Orange)	AWG#22	1007	no Wire	-VDC out

NC = No Connection
xx.x = ±0.5mm
xx.xx = ±0.25mm