

Power Inductors

Model HA72L-0630 series



Features:

- Operating Temperature Range -55°C to $+155^{\circ}\text{C}$
- Ambient Temperature, Maximum $+115^{\circ}\text{C}$
- Temperature Rise, 40°C
- RoHS Compliant
- AEC-Q200 Certified

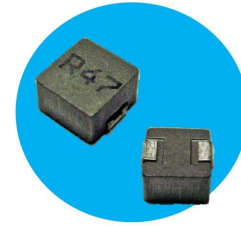

 All parts are Pb-free and comply with EU Directive 2011/65/EU (RoHS2)

Schematic

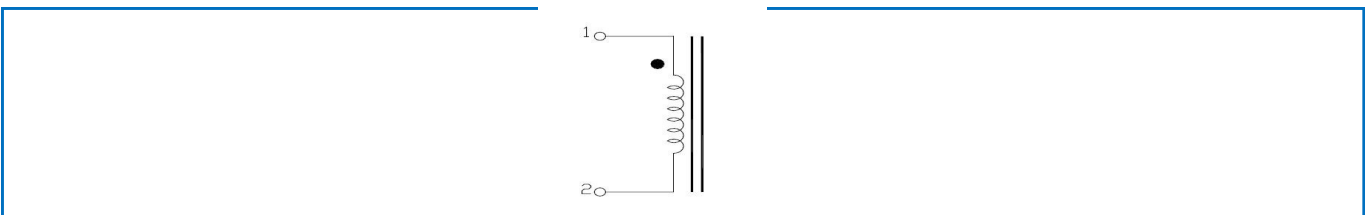

Specifications @ 25°C

Part Number	Inductance ($\mu\text{H} \pm 20\%$ @0A)	DCR (m Ω) Typ	DCR (m Ω) Max	I _{rms} (A)	I _{sat} (A)	Part Number	Inductance ($\mu\text{H} \pm 20\%$ @0A)	DCR (m Ω) Typ.	DCR (m Ω) Max	I _{rms} (A)	I _{sat} (A)
HA72L-0630R10LFTR	0.10	1.5	1.7	32.5	60.0	HA72L-06301R5LFTR	1.50	14.0	15.0	9.0	18.0
HA72L-0630R15LFTR	0.15	1.9	2.5	26.0	52.0	HA72L-06302R2LFTR	2.20	18.0	20.0	8.0	14.0
HA72L-0630R20LFTR	0.20	2.4	3.0	24.0	41.0	HA72L-06303R3LFTR	3.30	28.0	30.0	6.0	13.5
HA72L-0630R22LFTR	0.22	2.5	2.8	23.0	40.0	HA72L-06304R7LFTR	4.70	37.0	40.0	5.5	10.0
HA72L-0630R33LFTR	0.33	3.5	3.9	20.0	30.0	HA72L-06305R6LFTR	5.60	52.0	60.0	4.8	10.0
HA72L-0630R47LFTR	0.47	4.0	4.2	17.5	26.0	HA72L-06306R8LFTR	6.80	54.0	60.0	4.5	8.0
HA72L-0630R56LFTR	0.56	5.0	5.5	15.5	25.0	HA72L-06308R2LFTR	8.20	64.0	68.0	4.0	7.5
HA72L-0630R68LFTR	0.68	5.0	5.5	15.5	25.0	HA72L-0630100LFTR	10.0	102.0	105.0	3.0	7.0
HA72L-0630R82LFTR	0.82	6.7	8.0	13.0	24.0	HA72L-0630150LFTR	15.0	110.0	125.0	3.5	3.0
HA72L-06301R0LFTR	1.00	9.0	10.0	11.0	22.0	HA72L-0630220LFTR	22.0	129.0	135.0	2.9	2.5

- Notes: (1) I_{sat} is the saturation current at which inductance rolls off approximately 30% from its initial (zero DC)
 (2) I_{rms} is the approximate current at which $\Delta T = 40^{\circ}\text{C}$
 (3) Operating Temperature Range -55°C to $+155^{\circ}\text{C}$

General Note
 TT Electronics reserves the right to make changes in product specification without notice or liability. All information is subject to TT Electronics' own data and is considered accurate at time of going to print.

TT Electronics | BI Technologies
 A-1445, Jalan Tanjung Api
 25050 Kuantan Pahang Darul Makmur, Malaysia | Ph: +60 9 565 8888
www.ttelectronicsmagnetics.com/customer-service-enquiry

Electrical Characteristics @ 25°C

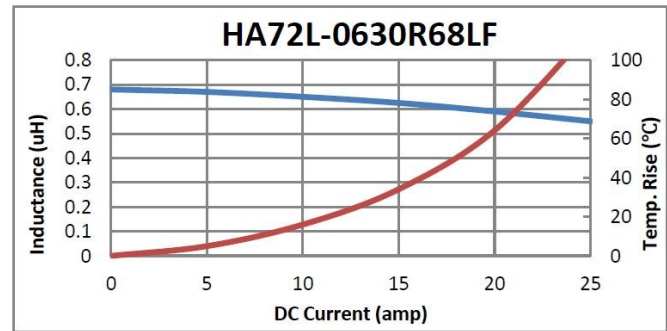
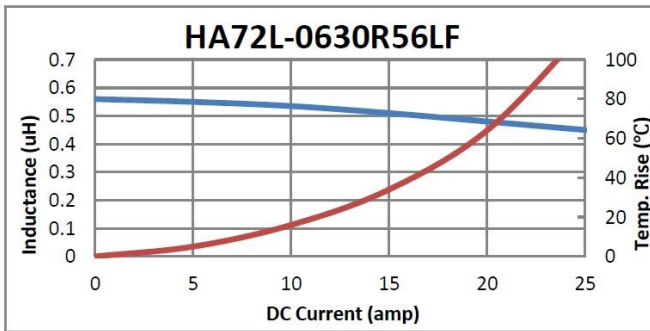
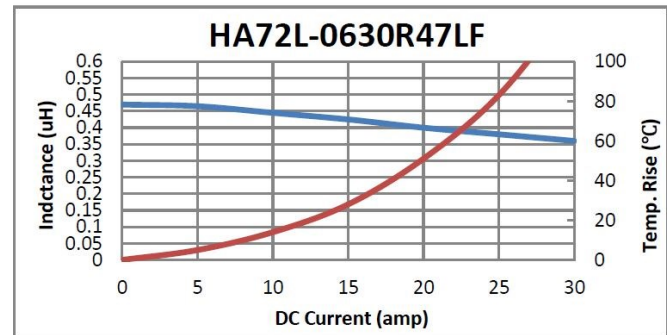
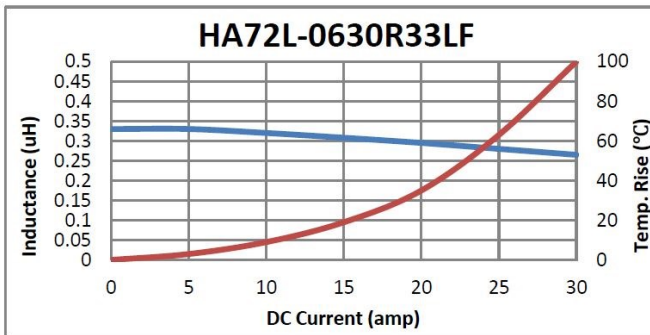
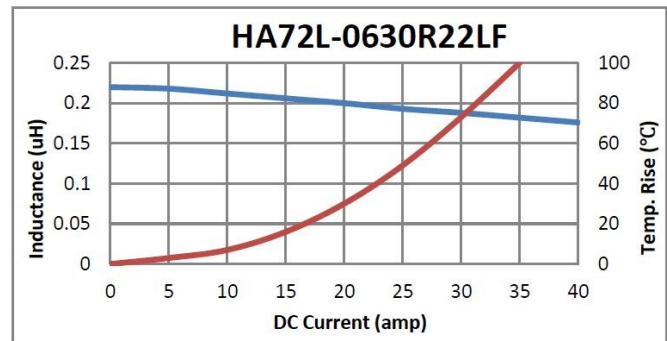
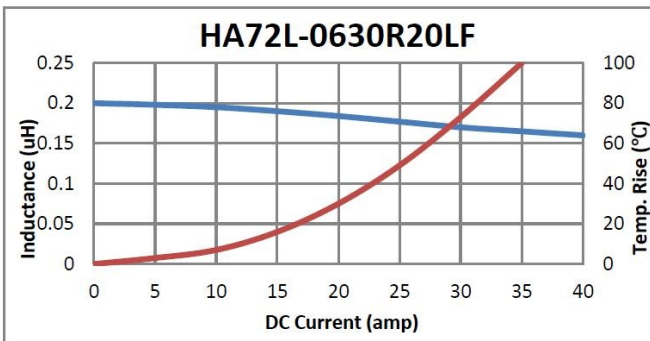
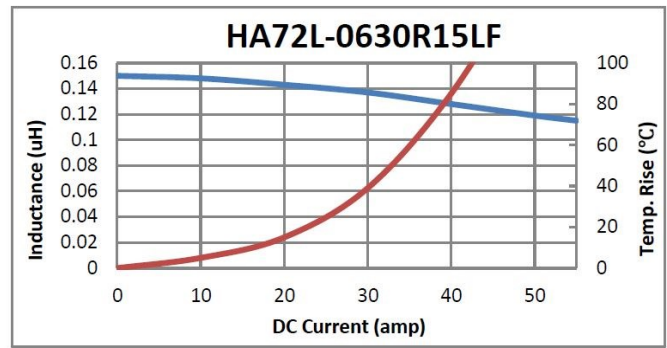
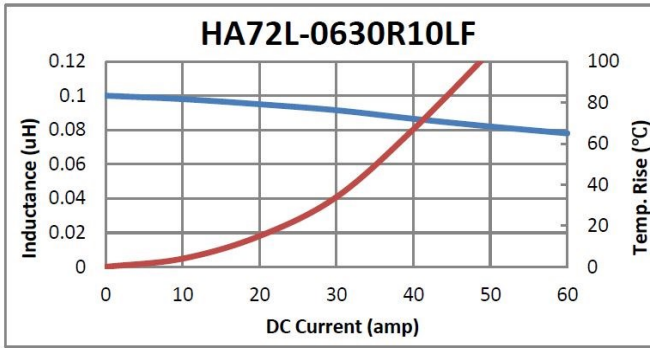

General Note
 TT Electronics reserves the right to make changes in product specification without notice or liability. All information is subject to TT Electronics' own data and is considered accurate at time of going to print.

TT Electronics | BI Technologies
 A-1445, Jalan Tanjung Api
 25050 Kuantan Pahang Darul Makmur, Malaysia | Ph: +60 9 565 8888
www.ttelectronicsmagnetics.com/customer-service-enquiry

Electrical Characteristics @ 25°C

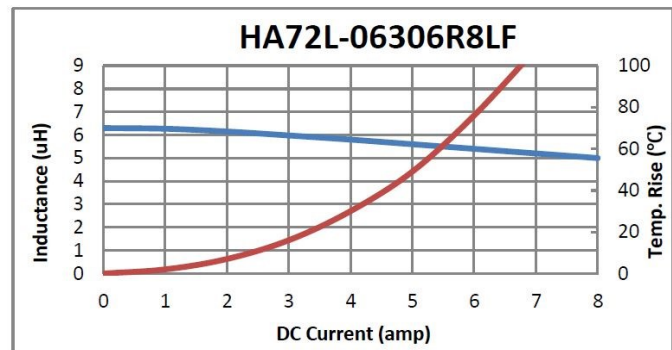
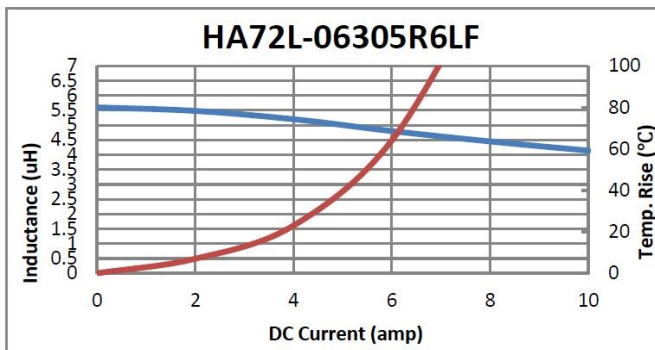
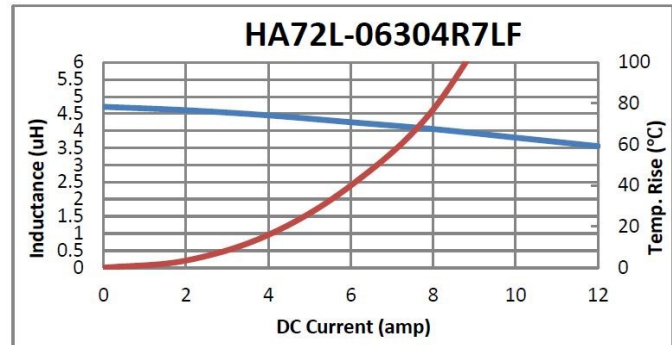
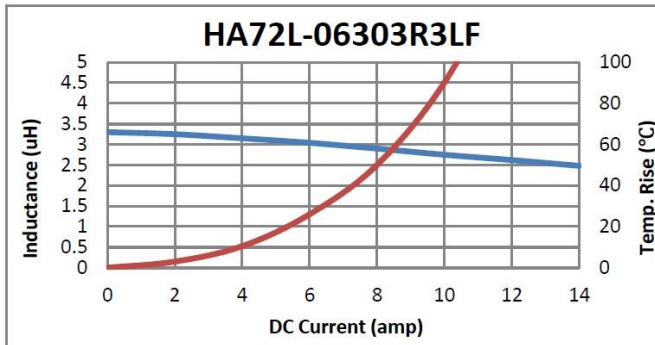
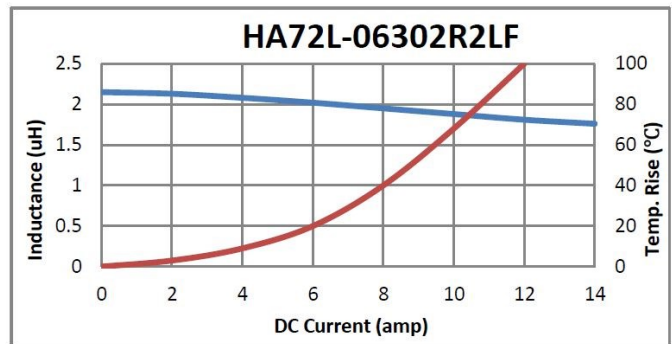
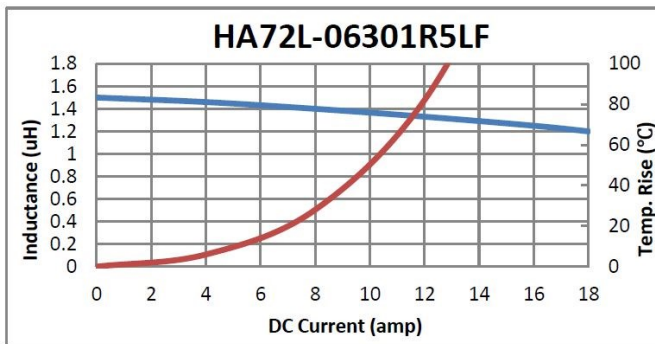
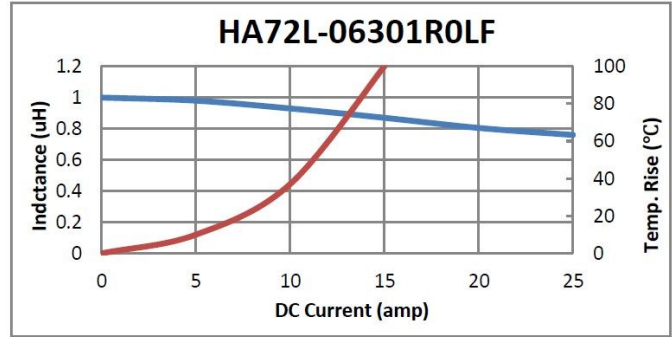
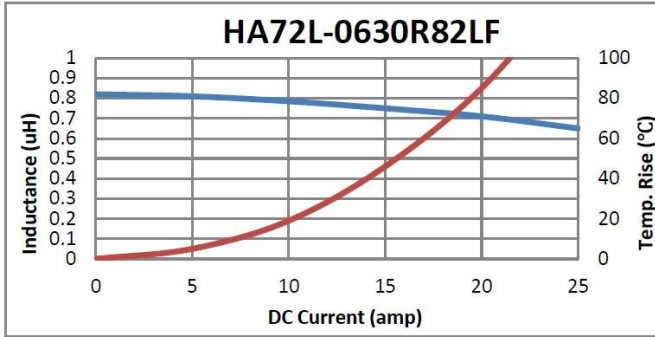

General Note
 TT Electronics reserves the right to make changes in product specification without notice or liability. All information is subject to TT Electronics' own data and is considered accurate at time of going to print.

TT Electronics | BI Technologies
 A-1445, Jalan Tanjung Api
 25050 Kuantan Pahang Darul Makmur, Malaysia | Ph: +60 9 565 8888
www.ttelectronicsmagnetics.com/customer-service-enquiry

Electrical Characteristics @ 25°C

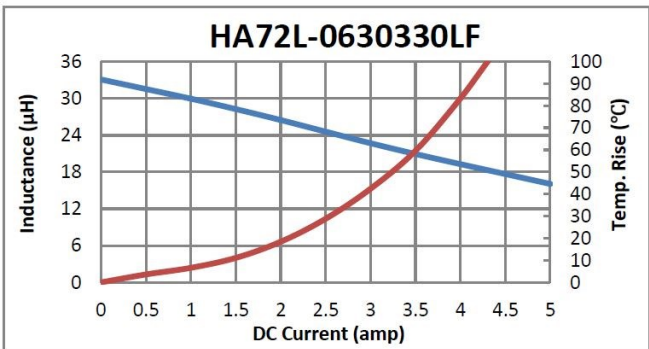
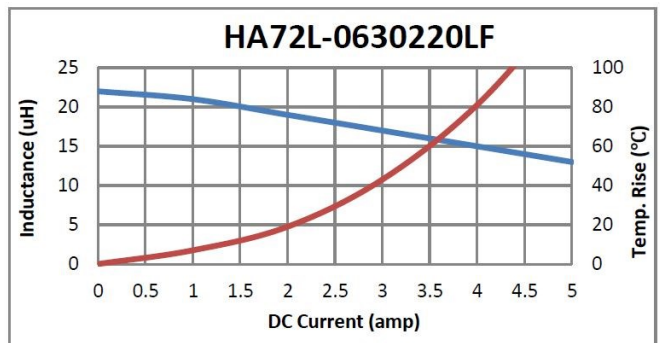
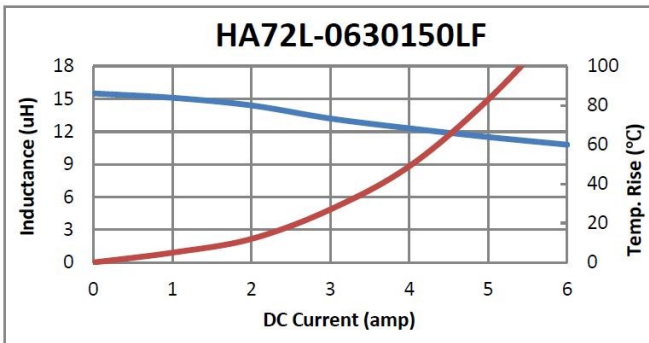
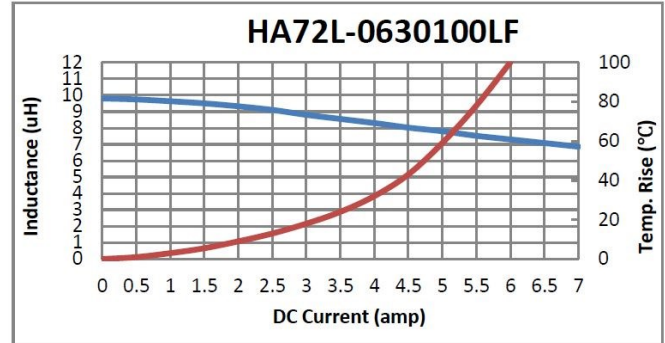
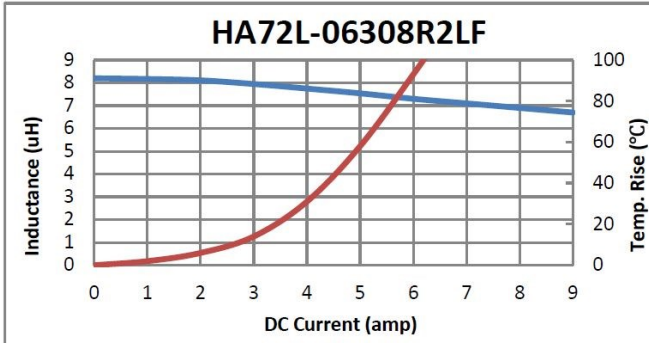

General Note
 TT Electronics reserves the right to make changes in product specification without notice or liability. All information is subject to TT Electronics' own data and is considered accurate at time of going to print.

TT Electronics | BI Technologies
 A-1445, Jalan Tanjung Api
 25050 Kuantan Pahang Darul Makmur, Malaysia | Ph: +60 9 565 8888
www.ttelectronicsmagnetics.com/customer-service-enquiry

Outline Dimensions (mm)

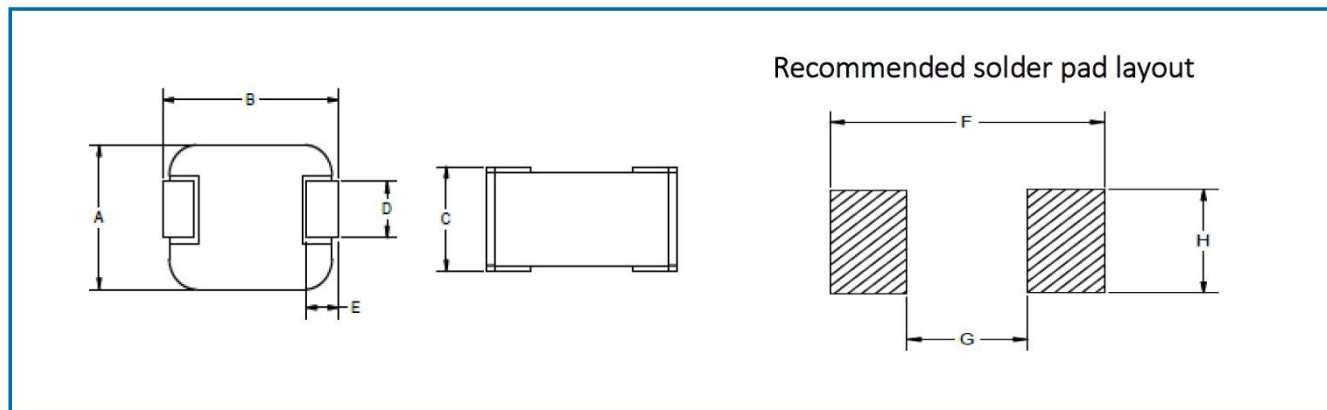

CASE SIZE	A(mm)	B(mm)	C(mm)	D(mm)	E(mm)	F(mm)	G(mm)	H(mm)
0630 series	6.6 ± 0.3	7.1 ± 0.3	3	3.0 ± 0.3	1.6 ± 0.5	7.40	3.70	3.50

Packaging

Standard:	Embossed Tape and Reel			
	Reel:	Diameter	All case size	= 13" (330mm)
		Capacity	Case size 0630	= 1,000 units

Ordering information

