

Toroid, High Current, High Temperature, Radial Led

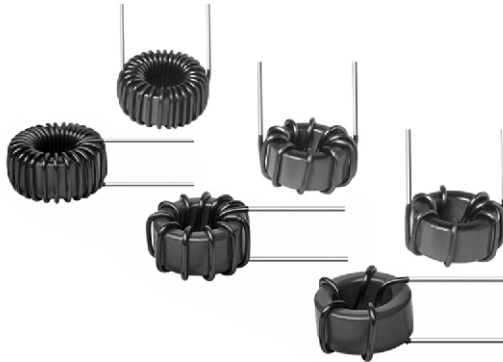

FEATURES

- Printed circuit mounting
- Toroid design reduces EMI
- Vertical or horizontal mounting to optimize PCB layout
- High temperature rating of 200 °C - no aging
- Material categorization: For definitions please see www.vishay.com/doc?99912

RoHS
COMPLIANT

APPLICATIONS

- Switching power supplies
- EMI/RFI filtering
- Output chokes

STANDARD ELECTRICAL SPECIFICATIONS in inches [millimeters]

IND. L ₀ (μH)	TOLERANCE (%)	DCR (VERTICAL MOUNT)		DCR (HORIZONTAL MOUNT)		RATED CURRENT VERTICAL MOUNT (A) ⁽¹⁾	RATED CURRENT HORIZONTAL MOUNT (A) ⁽¹⁾	SATURATION CURRENT (A) ⁽²⁾	LEAD DIAMETER D
		TYP. (Ω)	MAX. (Ω)	TYP. (Ω)	MAX. (Ω)				
0.47	20	0.0016	0.0024	0.0022	0.003	36	30	50	0.053 [1.346]
1.2	20	0.0028	0.0032	0.0032	0.0035	28	24	33	0.053 [1.346]
2.2	20	0.0036	0.0042	0.0042	0.0048	23	22	22	0.053 [1.346]
3.9	20	0.0045	0.0058	0.005	0.006	21	19.5	18	0.053 [1.346]
4.7	20	0.005	0.0064	0.0055	0.007	19	18.5	15	0.053 [1.346]
6.8	20	0.006	0.0074	0.0065	0.0078	18	17	14	0.053 [1.346]
10	20	0.0075	0.011	0.0084	0.012	15.8	15.5	10	0.053 [1.346]
22	20	0.015	0.019	0.016	0.02	10.8	10.5	7	0.042 [1.067]
39	20	0.02	0.025	0.022	0.028	9.2	9.1	5	0.042 [1.067]
100	20	0.05	0.069	0.054	0.075	5.5	5.5	3.0	0.034 [0.864]
470	20	0.17	0.29	0.175	0.3	2.8	2.8	1.5	0.027 [0.686]

Notes

- Operating temperature (ambient + ΔT): - 55 °C to + 200 °C, inductance tested at 0.25 V_{RMS}, 1 kHz, DCR tested at 25 °C ± 5 °C, all material rated at 200 °C
- (1) DC current that will cause an approx. ΔT of 50 °C
- (2) DC current that will cause L₀ to drop approx. 20 %

DIMENSIONS in inches [millimeters]

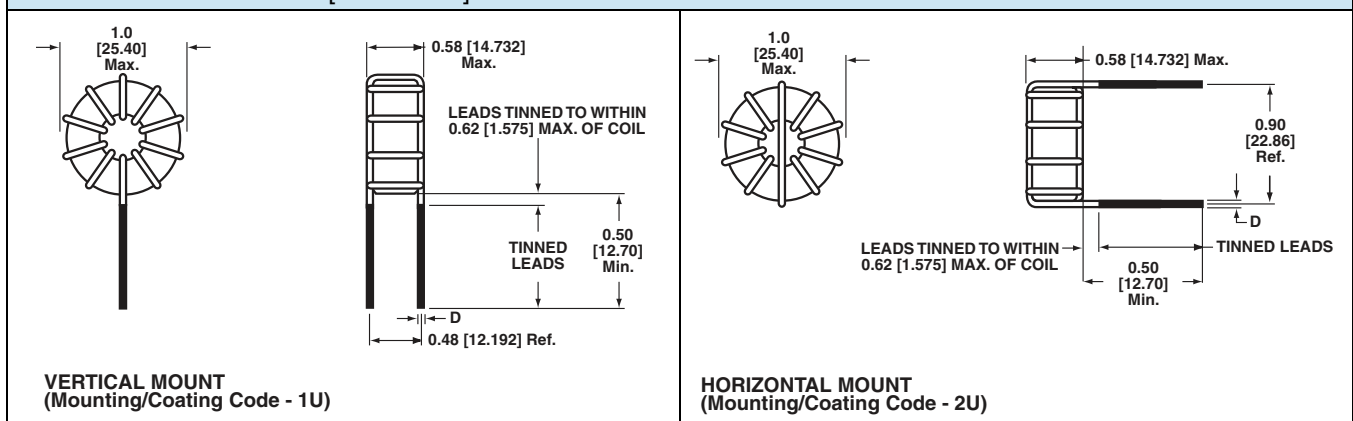



ORDERING INFORMATION					
TJ5-HT	1U	10 μ H	$\pm 20\%$	EB	e2
MODEL	MOUNTING/COATING CODE	INDUCTANCE VALUE	INDUCTANCE TOLERANCE	PACKAGE CODE	JEDEC LEAD (Pb)-FREE STANDARD

GLOBAL PART NUMBER												
T	J	5	1	U	E	B	1	0	0	M	H	T
MODEL			MOUNTING/COATING CODE		PACKAGE CODE		INDUCTANCE VALUE			INDUCTANCE TOLERANCE	SERIES	

PERFORMANCE GRAPHS: INDUCTANCE VS. DC CURRENT AND DC CURRENT VS. TEMPERATURE

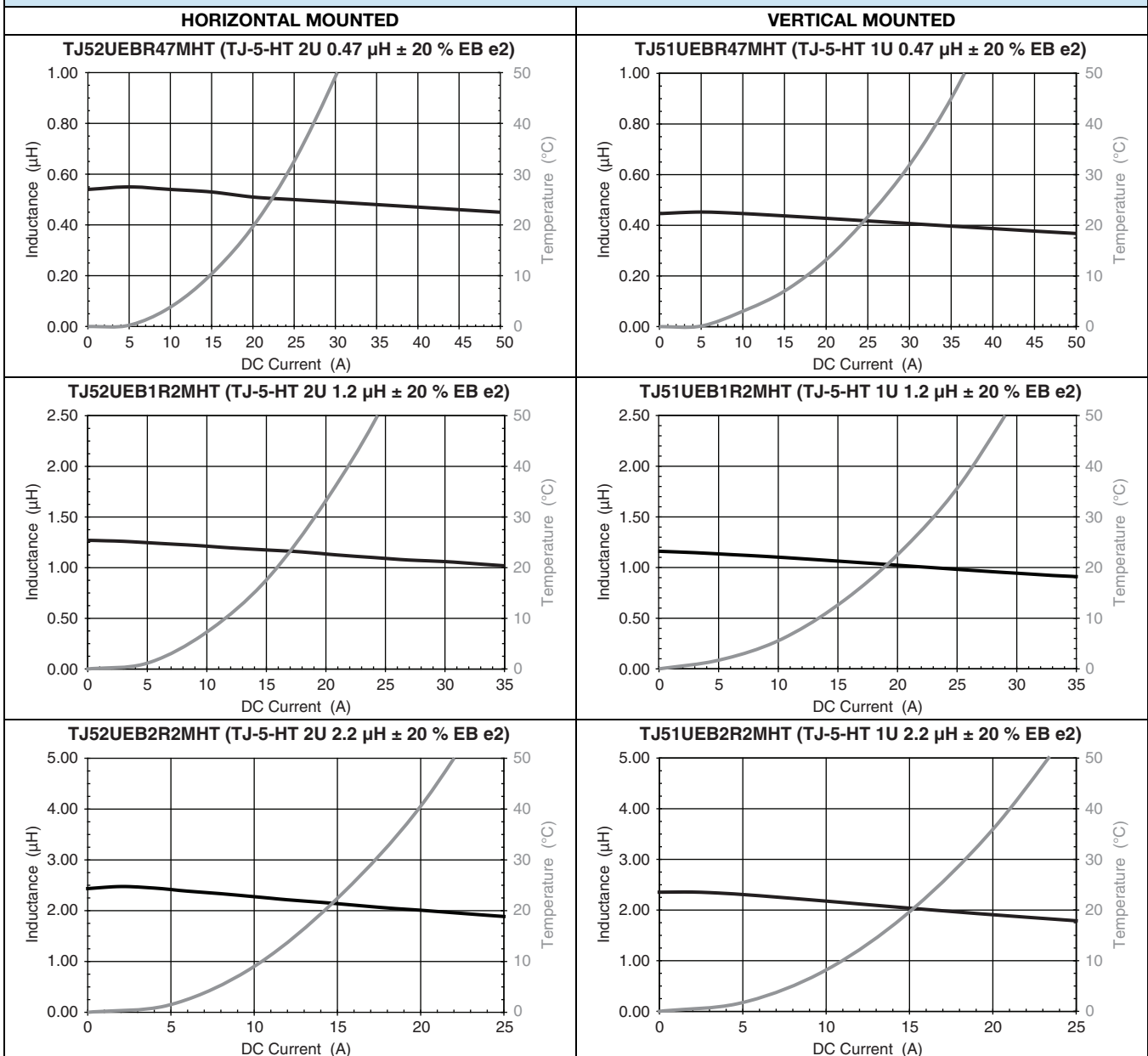



PERFORMANCE GRAPHS: INDUCTANCE VS. DC CURRENT AND DC CURRENT VS. TEMPERATURE

HORIZONTAL MOUNTED

VERTICAL MOUNTED

TJ52UEB3R9MHT (TJ-5-HT 2U 3.9 μH ± 20 % EB e2)

TJ51UEB3R9MHT (TJ-5-HT 1U 3.9 μH ± 20 % EB e2)

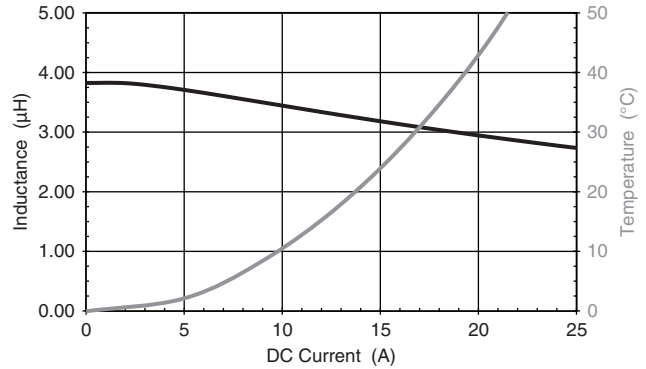
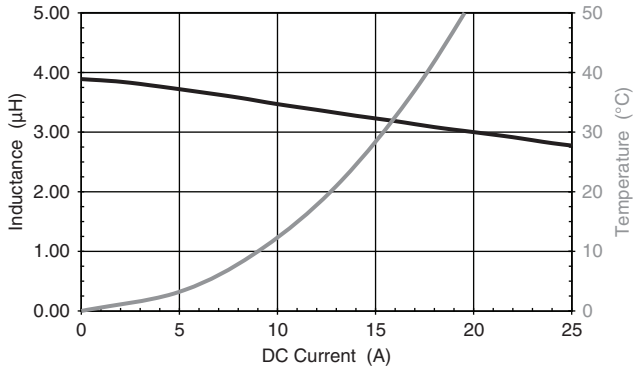

TJ52UEB4R7MHT (TJ-5-HT 2U 4.7 μH ± 20 % EB e2)

TJ51UEB4R7MHT (TJ-5-HT 1U 4.7 μH ± 20 % EB e2)

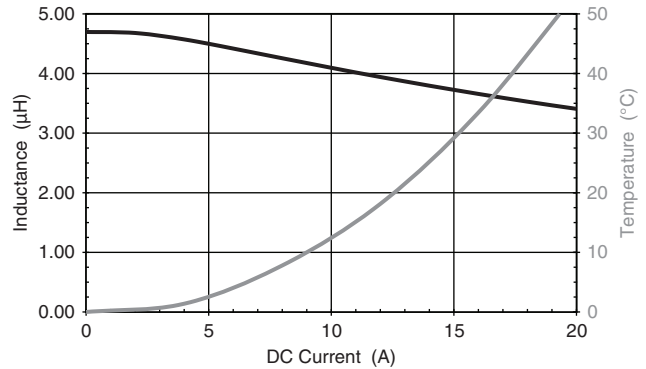
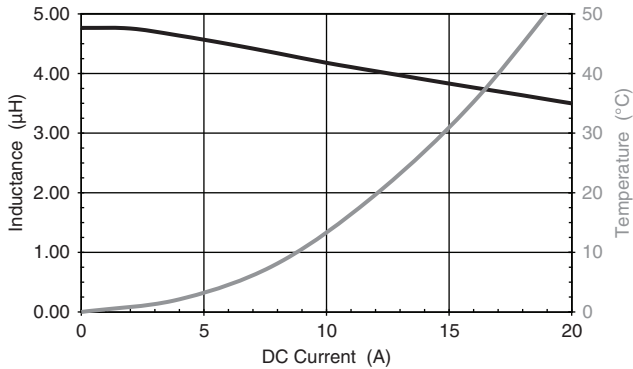

TJ52UEB6R8MHT (TJ-5-HT 2U 6.8 μH ± 20 % EB e2)

TJ51UEB6R8MHT (TJ-5-HT 1U 6.8 μH ± 20 % EB e2)

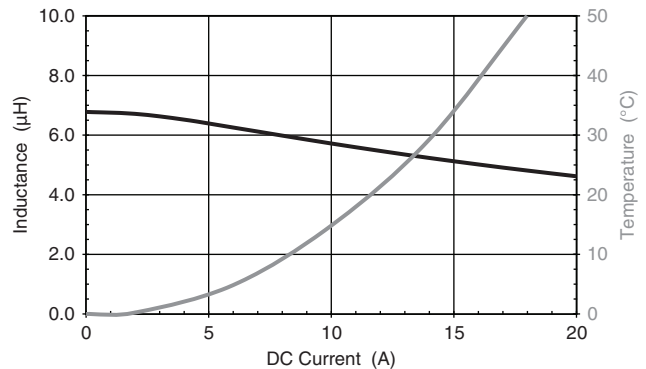
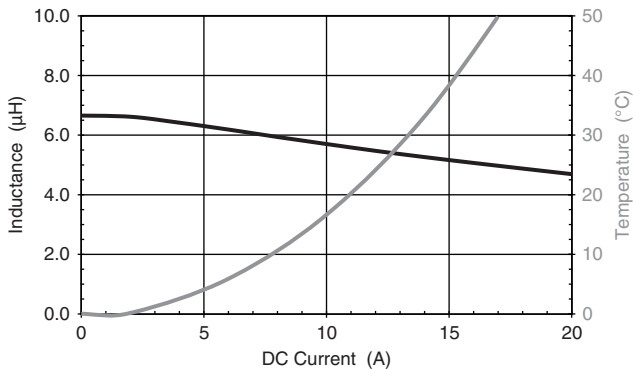

TJ52UEB100MHT (TJ-5-HT 2U 10 μH ± 20 % EB e2)

TJ51UEB100MHT (TJ-5-HT 1U 10 μH ± 20 % EB e2)

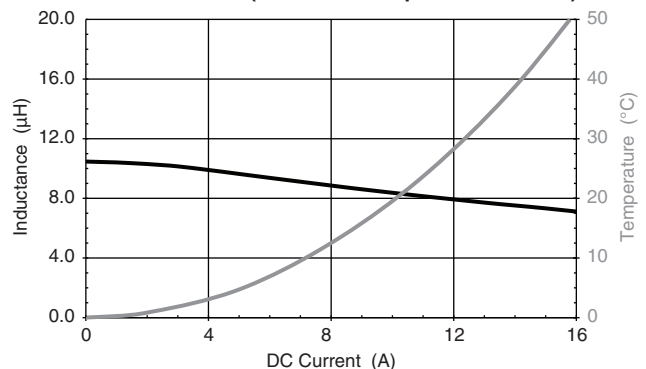
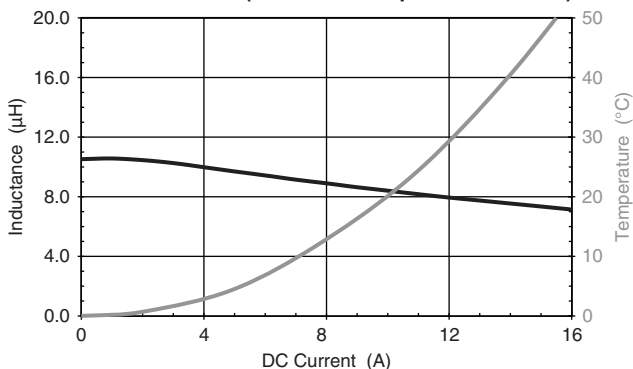



PERFORMANCE GRAPHS: INDUCTANCE VS. DC CURRENT AND DC CURRENT VS. TEMPERATURE

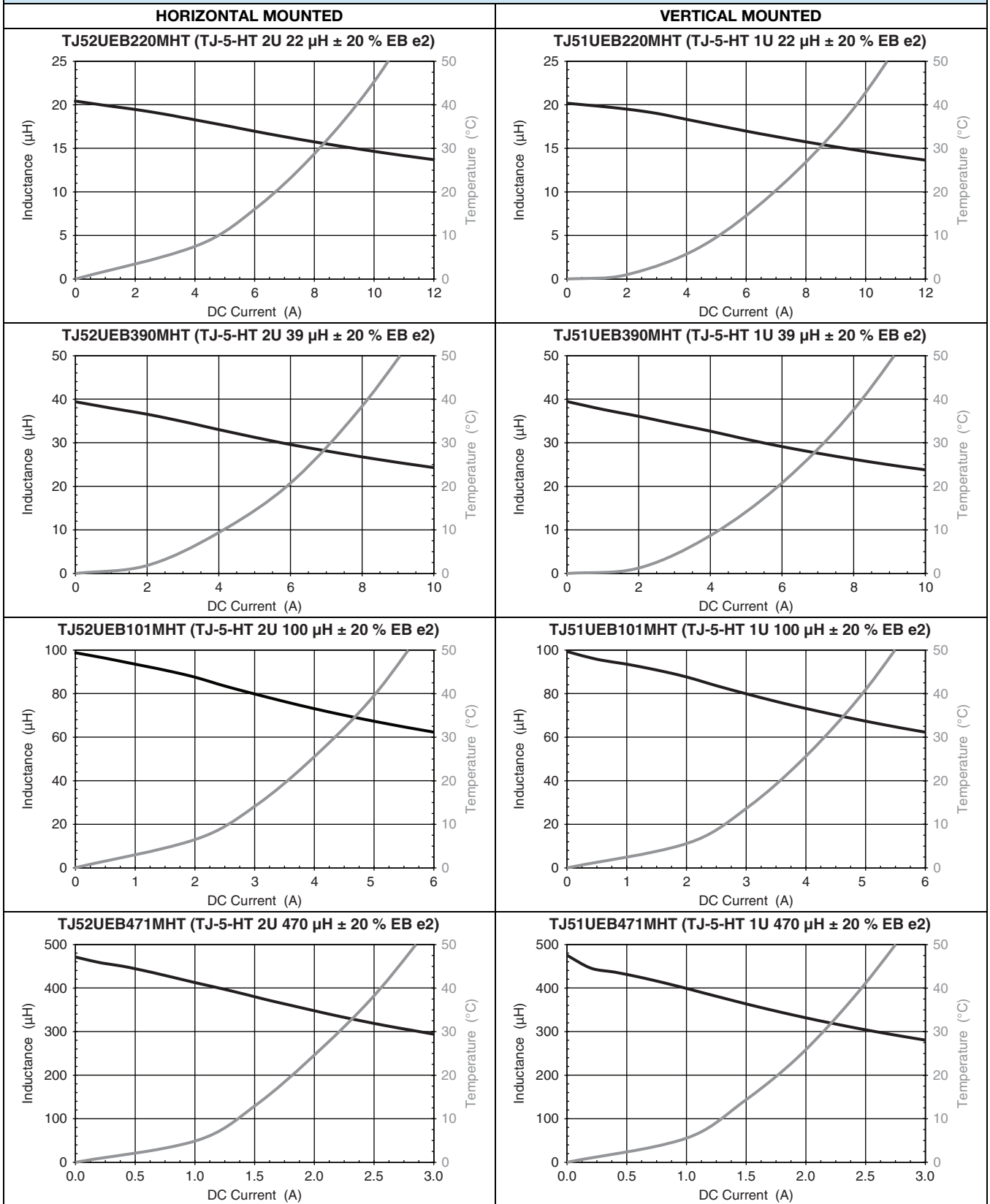



Disclaimer

ALL PRODUCT, PRODUCT SPECIFICATIONS AND DATA ARE SUBJECT TO CHANGE WITHOUT NOTICE TO IMPROVE RELIABILITY, FUNCTION OR DESIGN OR OTHERWISE.

Vishay Intertechnology, Inc., its affiliates, agents, and employees, and all persons acting on its or their behalf (collectively, "Vishay"), disclaim any and all liability for any errors, inaccuracies or incompleteness contained in any datasheet or in any other disclosure relating to any product.

Vishay makes no warranty, representation or guarantee regarding the suitability of the products for any particular purpose or the continuing production of any product. To the maximum extent permitted by applicable law, Vishay disclaims (i) any and all liability arising out of the application or use of any product, (ii) any and all liability, including without limitation special, consequential or incidental damages, and (iii) any and all implied warranties, including warranties of fitness for particular purpose, non-infringement and merchantability.

Statements regarding the suitability of products for certain types of applications are based on Vishay's knowledge of typical requirements that are often placed on Vishay products in generic applications. Such statements are not binding statements about the suitability of products for a particular application. It is the customer's responsibility to validate that a particular product with the properties described in the product specification is suitable for use in a particular application. Parameters provided in datasheets and / or specifications may vary in different applications and performance may vary over time. All operating parameters, including typical parameters, must be validated for each customer application by the customer's technical experts. Product specifications do not expand or otherwise modify Vishay's terms and conditions of purchase, including but not limited to the warranty expressed therein.

Except as expressly indicated in writing, Vishay products are not designed for use in medical, life-saving, or life-sustaining applications or for any other application in which the failure of the Vishay product could result in personal injury or death. Customers using or selling Vishay products not expressly indicated for use in such applications do so at their own risk. Please contact authorized Vishay personnel to obtain written terms and conditions regarding products designed for such applications.

No license, express or implied, by estoppel or otherwise, to any intellectual property rights is granted by this document or by any conduct of Vishay. Product names and markings noted herein may be trademarks of their respective owners.