

## TPA3110D2-Q1 15-W Filter-Free Stereo Class-D Audio Power Amplifier With SpeakerGuard™

### 1 Features

- Qualified for Automotive Applications
- AEC-Q100 Qualified With the Following Results:
  - Device Temperature Grade 1: –40°C to 125°C Ambient Operating Temperature Range
  - Device HBM ESD Classification Level H2
  - Device CDM ESD Classification Level C2
- 15-W/ch Into 8-Ω Loads at 10% THD+N From a 16-V Supply
- 10-W/ch Into 8-Ω Loads at 10% THD+N From a 13-V Supply
- 30-W Into a 4-Ω Mono Load at 10% THD+N From a 16-V Supply
- 90% Efficient Class-D Operation Eliminates Need for Heat Sinks
- Wide Supply Voltage Range Allows Operation from 8 V to 26 V
- Filter-Free Operation
- SpeakerGuard™ Protection Circuitry Includes Adjustable Power Limiter Plus DC Protection
- Flow Through Pin Out Facilitates Easy Board Layout
- Robust Pin-to-Pin Short-Circuit Protection and Thermal Protection with Auto Recovery Option
- Excellent THD+N and Pop-Free Performance
- Four Selectable Fixed Gain Settings
- Differential Inputs

### 2 Applications

- Automotive Noise Generation for HEV/EV
- Automotive Emergency Call Systems (eCall)
- Automotive Infotainment Systems (i.e. Head Unit, Connectivity Gateway, Cluster, Telematics, Navigation)
- ADAS Noise Generation for Blind Spot Detection, Security and Alarm Systems
- Professional Audio Equipment (Performance Amplifiers, Premium Microphones)
- Aerospace and Aviation Audio Systems

### 3 Description

The TPA3110D2-Q1 is a 15-W (per channel) efficient, Class-D audio power amplifier for driving bridged-tied stereo speakers. Advanced EMI suppression technology enables the use of inexpensive ferrite bead filters at the outputs while meeting EMC requirements. SpeakerGuard protection circuitry includes an adjustable power limiter and a DC detection circuit. The adjustable power limiter allows the user to set a virtual voltage rail lower than the chip supply to limit the amount of current through the speaker. The DC detect circuit measures the frequency and amplitude of the PWM signal and shuts off the output stage if the input capacitors are damaged or shorts exist on the inputs.

The TPA3110D2-Q1 can drive stereo speakers as low as 4 Ω. The high efficiency of the device, 90%, eliminates the need for an external heat sink when playing music.

The outputs are also fully protected against shorts to GND, VCC, and output-to-output. The short-circuit protection and thermal protection includes an auto-recovery feature.

#### Device Information<sup>(1)</sup>

PART NUMBER	PACKAGE	BODY SIZE (NOM)
TPA3110D2-Q1	HTSSOP (28)	9.70 mm x 4.40 mm

(1) For all available packages, see the orderable addendum at the end of the data sheet.

#### TPA3110D2-Q1 Simplified Application Schematic

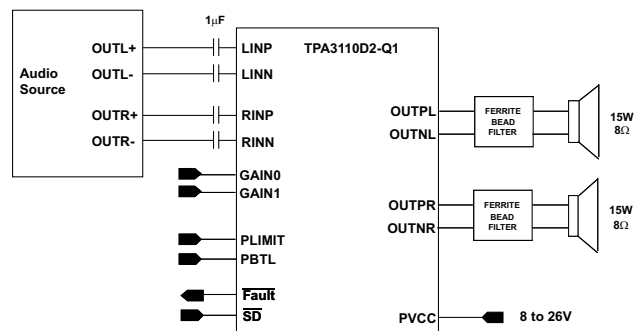



## 5 Pin Configuration and Functions

**PWP Package**  
**28-Pin HTSSOP With PowerPAD™ IC Package**  
**Top View**

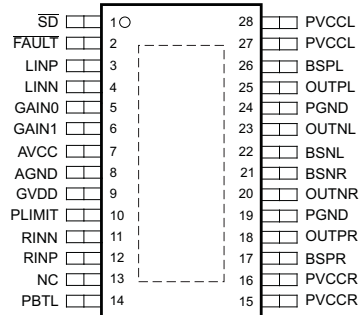

### Pin Functions

PIN		TYPE	DESCRIPTION
NO.	NAME		
1	$\overline{SD}$	I	Shutdown logic input for audio amp (LOW = outputs Hi-Z, HIGH = outputs enabled), TTL logic levels with compliance to AVCC.
2	$\overline{FAULT}$	O	Open drain output used to display short circuit or DC detect fault status. Voltage compliant to AVCC. Short circuit faults can be set to auto-recovery by connecting FAULT pin to $\overline{SD}$ pin. Otherwise, both short circuit faults and DC detect faults must be reset by cycling PVCC.
3	LINP	I	Positive audio input for left channel, biased at 3 V.
4	LINN	I	Negative audio input for left channel, biased at 3 V.
5	GAIN0	I	Gain select least significant bit, TTL logic levels with compliance to AVCC.
6	GAIN1	I	Gain select most significant bit, TTL logic levels with compliance to AVCC.
7	AVCC	P	Analog supply
8	AGND	—	Analog signal ground, connect to the thermal pad.
9	GVDD	O	High-side FET gate drive supply. The nominal voltage is 7 V. GVDD should also be used as a supply for the PLIMIT function.
10	PLIMIT	I	Power limit level adjust. Connect a resistor divider from GVDD to GND to set power limit. Connect directly to GVDD for no power limit.
11	RINN	I	Negative audio input for right channel, biased at 3 V.
12	RINP	I	Positive audio input for right channel, biased at 3 V.
13	NC	—	Not connected
14	PBTL	I	Parallel BTL mode switch
15	PVCCR	P	Power supply for right channel H-bridge. Right channel and left channel power supply inputs are connect internally.
16	PVCCR	P	Power supply for right channel H-bridge. Right channel and left channel power supply inputs are connect internally.
17	BSPR	I	Bootstrap I/O for right channel, positive high-side FET
18	OUTPR	O	Class-D H-bridge positive output for right channel
19	PGND	—	Power ground for the H-bridges
20	OUTNR	O	Class-D H-bridge negative output for right channel
21	BSNR	I	Bootstrap I/O for right channel, negative high-side FET
22	BSNL	I	Bootstrap I/O for left channel, negative high-side FET
23	OUTNL	O	Class-D H-bridge negative output for left channel
24	PGND	—	Power ground for the H-bridges
25	OUTPL	O	Class-D H-bridge positive output for left channel
26	BSPL	I	Bootstrap I/O for left channel, positive high-side FET

**Pin Functions (continued)**

PIN		TYPE	DESCRIPTION
NO.	NAME		
27	PVCCL	P	Power supply for left channel H-bridge. Right channel and left channel power supply inputs are connect internally.
28	PVCCL	P	Power supply for left channel H-bridge. Right channel and left channel power supply inputs are connect internally.

## 6 Specifications

### 6.1 Absolute Maximum Ratings

 over operating free-air temperature range (unless otherwise noted)<sup>(1)</sup>

			MIN	MAX	UNIT
V <sub>CC</sub>	Supply voltage	AVCC, PVCC	-0.3	30	V
V <sub>I</sub>	Interface pin voltage	$\overline{SD}$ , GAIN0, GAIN1, PBTL, $\overline{FAULT}$ <sup>(2)</sup>	-0.3	V <sub>CC</sub> + 0.3	V
		PLIMIT	-0.3	GVDD + 0.3	V
		RINN, RINP, LINN, LINP	-0.3	6.3	V
				< 10	V/ms
R <sub>L</sub>	Minimum load resistance	BTL: PVCC > 15 V		4.8	
		BTL: PVCC ≤ 15 V		3.2	
		PBTL		3.2	
Continuous total power dissipation			See the <a href="#">Thermal Information</a> Table		
T <sub>A</sub>	Operating free-air temperature		-40	125	°C
T <sub>J</sub>	Operating junction temperature <sup>(3)</sup>		-40	150	°C
T <sub>stg</sub>	Storage temperature		-65	150	°C

- (1) Stresses beyond those listed under *absolute maximum ratings* may cause permanent damage to the device. These are stress ratings only, and functional operations of the device at these or any other conditions beyond those indicated under *recommended operating conditions* is not implied. Exposure to absolute-maximum-rated conditions for extended periods may affect device reliability.
- (2) The voltage slew rate of these pins must be restricted to no more than 10 V/ms. For higher slew rates, use a 100-kΩ resistor in series with the pins, per application note [SLUA626](#).
- (3) The TPA3110D2-Q1 incorporates an exposed thermal pad on the underside of the chip. This acts as a heatsink, and it must be connected to a thermally dissipating plane for proper power dissipation. Failure to do so may result in the device going into thermal protection shutdown. See TI Technical Brief [SLMA002](#) for more information about using the TSSOP thermal pad.

### 6.2 ESD Ratings

		VALUE	UNIT
V <sub>(ESD)</sub>	Electrostatic discharge	Human-body model (HBM), per AEC Q100-002 <sup>(1)</sup>	±4000
		Charged-device model (CDM), per AEC Q100-011	±250
		Machine Model (MM) per JESD22-A115	±200

- (1) AEC Q100-002 indicates that HBM stressing shall be in accordance with the ANSI/ESDA/JEDEC JS-001 specification.

### 6.3 Recommended Operating Conditions

over operating free-air temperature range (unless otherwise noted)

			MIN	MAX	UNIT
V <sub>CC</sub>	Supply voltage	PVCC, AVCC	8	26	V
V <sub>IH</sub>	High-level input voltage	$\overline{SD}$ , GAIN0, GAIN1, PBTL	2		V
V <sub>IL</sub>	Low-level input voltage	$\overline{SD}$ , GAIN0, GAIN1, PBTL		0.8	V
V <sub>OL</sub>	Low-level output voltage	$\overline{FAULT}$ , R <sub>PULL-UP</sub> = 100k, V <sub>CC</sub> = 26 V		0.8	V
I <sub>IH</sub>	High-level input current	$\overline{SD}$ , GAIN0, GAIN1, PBTL, V <sub>I</sub> = 2 V, V <sub>CC</sub> = 18 V		50	μA
I <sub>IL</sub>	Low-level input current	$\overline{SD}$ , GAIN0, GAIN1, PBTL, V <sub>I</sub> = 0.8 V, V <sub>CC</sub> = 18 V		5	μA
T <sub>A</sub>	Operating free-air temperature		-40	125	°C

## 6.4 Thermal Information

THERMAL METRIC <sup>(1)(2)</sup>		TPA3110D2-Q1	UNIT
		PWP (HTSSOP)	
		28 Pins	
$\theta_{JA}$	Junction-to-ambient thermal resistance	30.3	°C/W
$\theta_{JcTop}$	Junction-to-case (top) thermal resistance	33.5	°C/W
$\theta_{JB}$	Junction-to-board thermal resistance	17.5	°C/W
$\psi_{JT}$	Junction-to-top characterization parameter	0.9	°C/W
$\psi_{JB}$	Junction-to-board characterization parameter	7.2	°C/W
$\theta_{JcBot}$	Junction-to-case (bottom) thermal resistance	0.9	°C/W

(1) For more information about traditional and new thermal metrics, see the *Semiconductor and IC Package Thermal Metrics* application report, [SPRA953](#).

(2) For thermal estimates of this device based on PCB copper area, see the TI PCB Thermal Calculator.

## 6.5 DC Characteristics

$T_A = -40^\circ\text{C}$  to  $125^\circ\text{C}$ ,  $V_{CC} = 24\text{ V}$ ,  $R_L = 8\ \Omega$  (unless otherwise noted)

PARAMETER		TEST CONDITIONS	MIN	TYP	MAX	UNIT	
$ V_{OS} $	Class-D output offset voltage (measured differentially)	$V_I = 0\text{ V}$ , Gain = 36 dB		1.5	15	mV	
$I_{CC}$	Quiescent supply current	$\overline{SD} = 2\text{ V}$ , no load, $PV_{CC} = 24\text{ V}$		32	50	mA	
$I_{CC(SD)}$	Quiescent supply current in shutdown mode	$\overline{SD} = 0.8\text{ V}$ , no load, $PV_{CC} = 24\text{ V}$		250	400	$\mu\text{A}$	
$r_{DS(on)}$	Drain-source on-state resistance	$V_{CC} = 12\text{ V}$ , $I_O = 500\text{ mA}$ , $T_J = 25^\circ\text{C}$				m $\Omega$	
G	Gain	GAIN1 = 0.8 V	High side	240			
			Low side	240			
		GAIN1 = 2 V	GAIN0 = 0.8 V	19	20	21	dB
			GAIN0 = 2 V	25	26	27	
G	Gain	GAIN1 = 2 V	GAIN0 = 0.8 V	31	32	33	dB
			GAIN0 = 2 V	35	36	37	
$t_{on}$	Turn-on time	$\overline{SD} = 2\text{ V}$		14		ms	
$t_{OFF}$	Turn-off time	$\overline{SD} = 0.8\text{ V}$		2		$\mu\text{s}$	
GVDD	Gate drive supply	$I_{GVDD} = 100\ \mu\text{A}$	6.4	6.9	7.4	V	
$t_{DCDET}$	DC detect time	$V_{(RINN)} = 6\text{ V}$ , $VRINP = 0\text{ V}$		420		ms	

## 6.6 DC Characteristics

$T_A = -40^\circ\text{C}$  to  $125^\circ\text{C}$ ,  $V_{CC} = 12\text{ V}$ ,  $R_L = 8\ \Omega$  (unless otherwise noted)

PARAMETER		TEST CONDITIONS	MIN	TYP	MAX	UNIT	
$ V_{OS} $	Class-D output offset voltage (measured differentially)	$V_I = 0\text{ V}$ , Gain = 36 dB		1.5	15	mV	
$I_{CC}$	Quiescent supply current	$\overline{SD} = 2\text{ V}$ , no load, $PV_{CC} = 12\text{ V}$		20	35	mA	
$I_{CC(SD)}$	Quiescent supply current in shutdown mode	$\overline{SD} = 0.8\text{ V}$ , no load, $PV_{CC} = 12\text{ V}$		200		$\mu\text{A}$	
$r_{DS(on)}$	Drain-source on-state resistance	$V_{CC} = 12\text{ V}$ , $I_O = 500\text{ mA}$ , $T_J = 25^\circ\text{C}$				m $\Omega$	
G	Gain	GAIN1 = 0.8 V	High side	240			
			Low side	240			
		GAIN1 = 2 V	GAIN0 = 0.8 V	19	20	21	dB
			GAIN0 = 2 V	25	26	27	
G	Gain	GAIN1 = 2 V	GAIN0 = 0.8 V	31	32	33	dB
			GAIN0 = 2 V	35	36	37	
$t_{ON}$	Turn-on time	$\overline{SD} = 2\text{ V}$		14		ms	
$t_{OFF}$	Turn-off time	$\overline{SD} = 0.8\text{ V}$		2		$\mu\text{s}$	
GVDD	Gate drive supply	$I_{GVDD} = 2\text{ mA}$	6.4	6.9	7.4	V	
$V_O$	Output voltage maximum under PLIMIT control	$V_{(PLIMIT)} = 2\text{ V}$ ; $V_I = 1\text{ V}_{RMS}$	6.75	7.90	8.75	V	

**TPA3110D2-Q1**

SLOS794B – SEPTEMBER 2012 – REVISED SEPTEMBER 2015

[www.ti.com](http://www.ti.com)
**6.7 AC Characteristics**
 $T_A = -40^{\circ}\text{C}$  to  $125^{\circ}\text{C}$ ,  $V_{CC} = 24\text{ V}$ ,  $R_L = 8\ \Omega$  (unless otherwise noted)

PARAMETER		TEST CONDITIONS	MIN	TYP	MAX	UNIT
$K_{SVR}$	Power supply ripple rejection	200 mV <sub>PP</sub> ripple at 1 kHz, Gain = 20 dB, inputs AC-coupled to AGND		-70		dB
$P_O$	Continuous output power	THD+N = 10%, f = 1 kHz, $V_{CC} = 16\text{ V}$		15		W
THD+N	Total harmonic distortion + noise	$V_{CC} = 16\text{ V}$ , f = 1 kHz, $P_O = 7.5\text{ W}$ (half-power)		0.1%		
$V_n$	Output integrated noise	20 Hz to 22 kHz, A-weighted filter, Gain = 20 dB		65		$\mu\text{V}$
				-80		dBV
	Crosstalk	$V_O = 1\text{ V}_{RMS}$ , Gain = 20 dB, f = 1 kHz		-100		dB
SNR	Signal-to-noise ratio	Maximum output at THD+N < 1%, f = 1 kHz, Gain = 20 dB, A-weighted		102		dB
$f_{OSC}$	Oscillator frequency		250	310	350	kHz
	Thermal trip point			150		$^{\circ}\text{C}$
	Thermal hysteresis			15		$^{\circ}\text{C}$

**6.8 AC Characteristics**
 $T_A = -40^{\circ}\text{C}$  to  $125^{\circ}\text{C}$ ,  $V_{CC} = 12\text{ V}$ ,  $R_L = 8\ \Omega$  (unless otherwise noted)

PARAMETER		TEST CONDITIONS	MIN	TYP	MAX	UNIT
$K_{SVR}$	Supply ripple rejection	200 mV <sub>PP</sub> ripple from 20 Hz–1 kHz, Gain = 20 dB, inputs AC-coupled to AGND		-70		dB
$P_O$	Continuous output power	THD+N = 10%, f = 1 kHz; $V_{CC} = 13\text{ V}$		10		W
THD+N	Total harmonic distortion + noise	$R_L = 8\ \Omega$ , f = 1 kHz, $P_O = 5\text{ W}$ (half-power)		0.06%		
$V_n$	Output integrated noise	20 Hz to 22 kHz, A-weighted filter, Gain = 20 dB		65		$\mu\text{V}$
				-80		dBV
	Crosstalk	$P_O = 1\text{ W}$ , Gain = 20 dB, f = 1 kHz		-100		dB
SNR	Signal-to-noise ratio	Maximum output at THD+N < 1%, f = 1 kHz, Gain = 20 dB, A-weighted		102		dB
$f_{OSC}$	Oscillator frequency		250	310	350	kHz
	Thermal trip point			150		$^{\circ}\text{C}$
	Thermal hysteresis			15		$^{\circ}\text{C}$

## 6.9 Typical Characteristics

All measurements taken at 1 kHz, unless otherwise noted. The TPA3110D2-Q1 EVM (which is available at [ti.com](http://ti.com)) made the measurements.

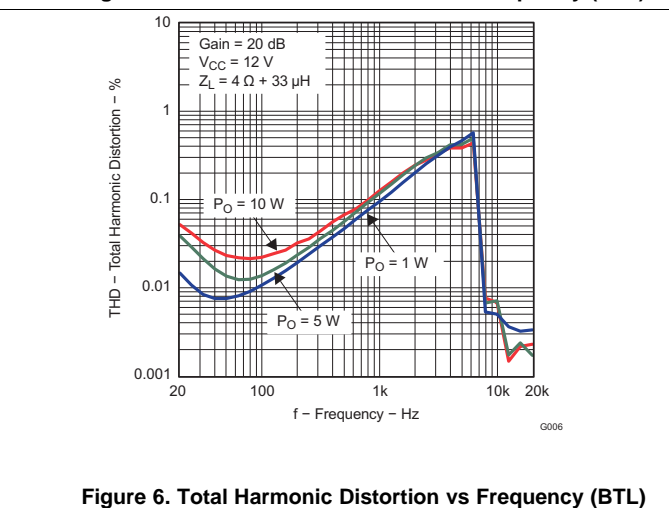
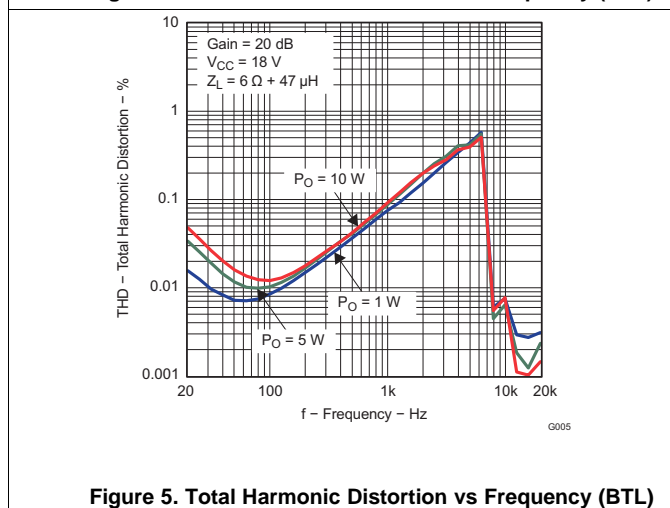
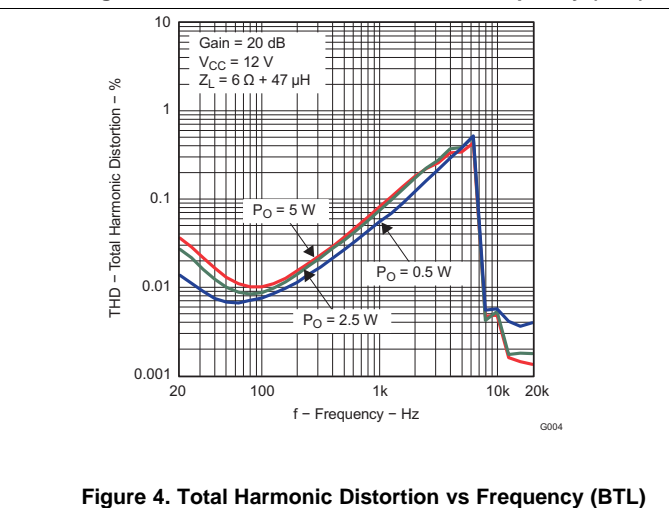
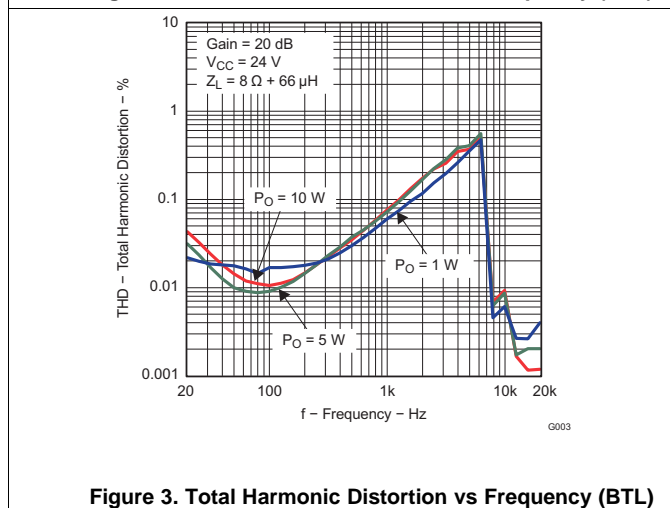
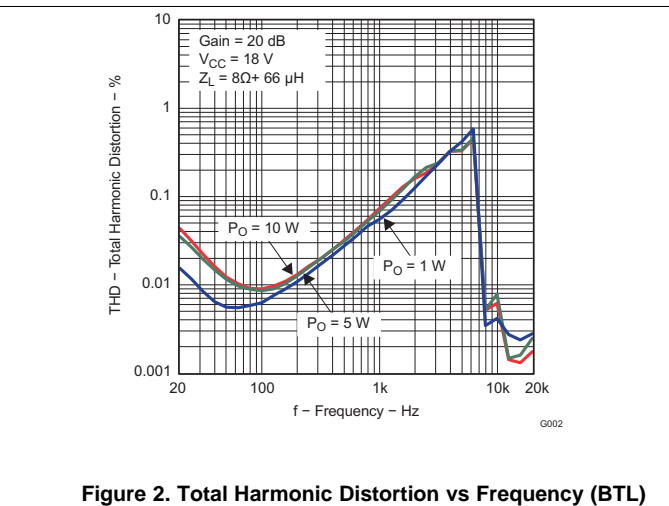
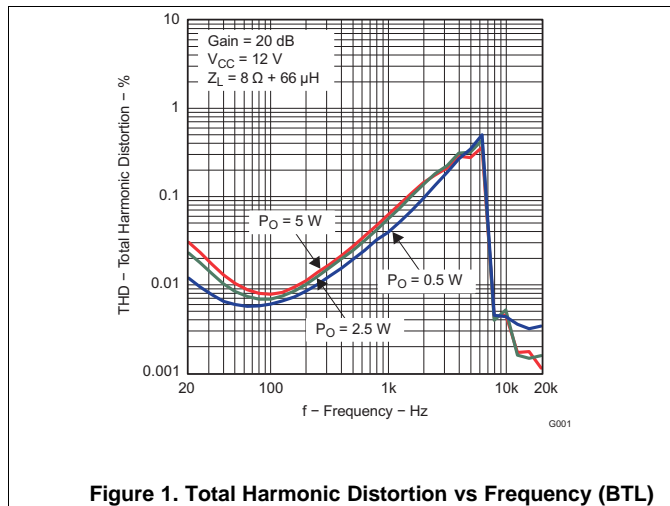

### Typical Characteristics (continued)

All measurements taken at 1 kHz, unless otherwise noted. The TPA3110D2-Q1 EVM (which is available at [ti.com](http://ti.com)) made the measurements.

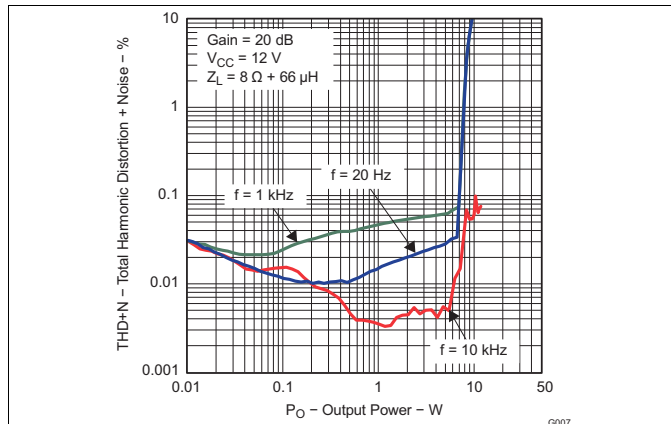

Lighter color represents thermally limited region.

**Figure 7. Total Harmonic Distortion + Noise vs Output Power (BTL)**

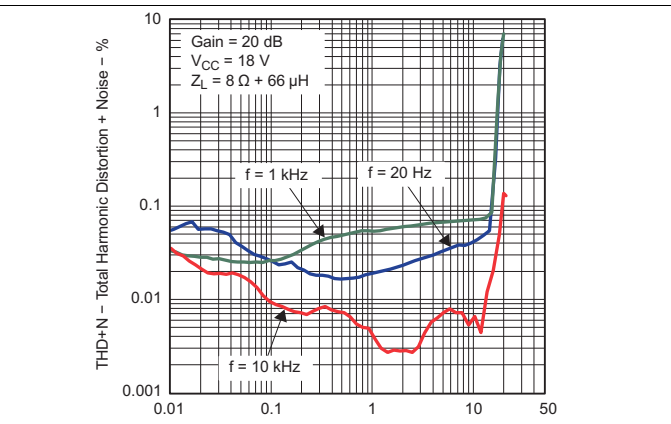

**Figure 8. Total Harmonic Distortion + Noise vs Output Power (BTL)**

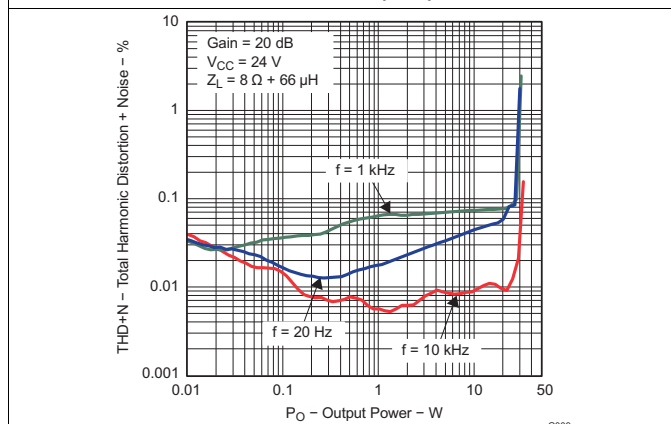

**Figure 9. Total Harmonic Distortion + Noise vs Output Power (BTL)**

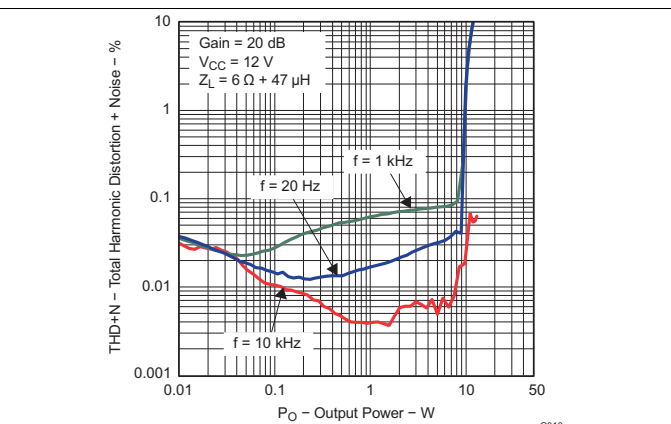

**Figure 10. Total Harmonic Distortion + Noise vs Output Power (BTL)**

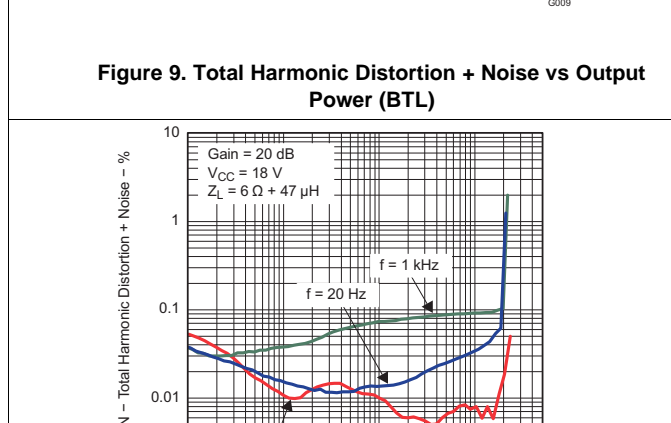

**Figure 11. Total Harmonic Distortion + Noise vs Output Power (BTL)**

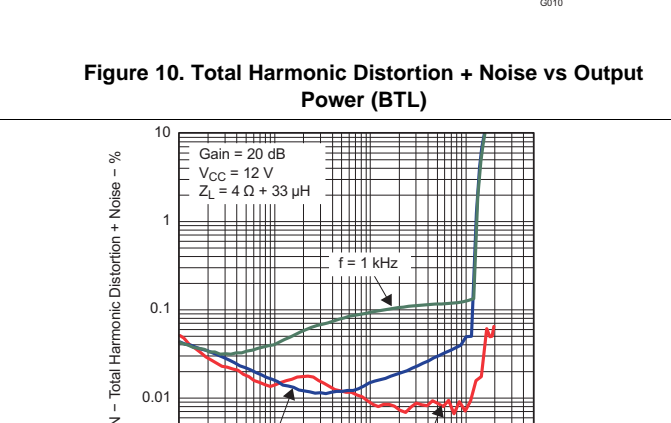

**Figure 12. Total Harmonic Distortion + Noise vs Output Power (BTL)**



Typical Characteristics (continued)

All measurements taken at 1 kHz, unless otherwise noted. The TPA3110D2-Q1 EVM (which is available at [ti.com](http://ti.com)) made the measurements.

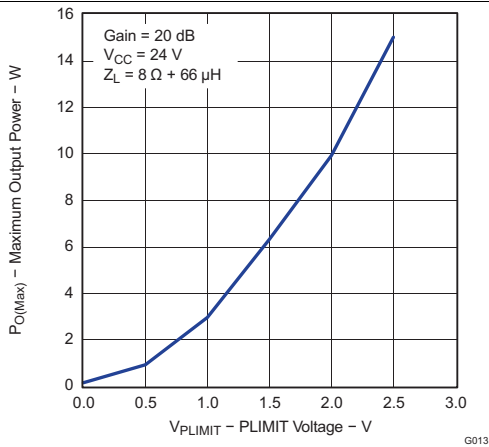
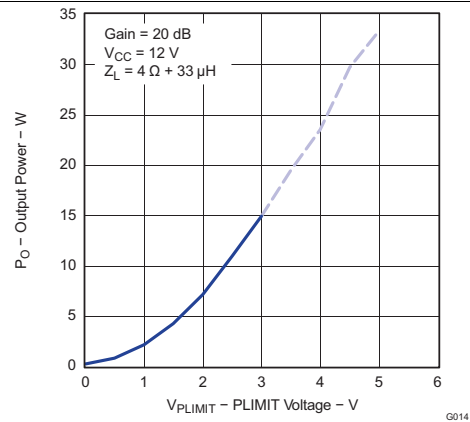

Figure 13. Maximum Output Power vs PLIMIT Voltage (BTL)



Note: Dashed lines represent thermally limited regions.

Figure 14. Output Power vs PLIMIT Voltage (BTL)

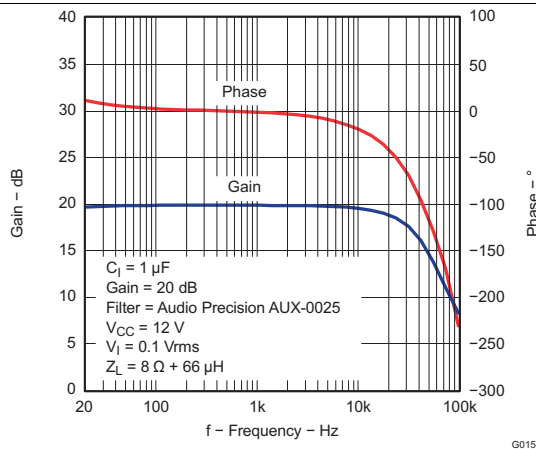
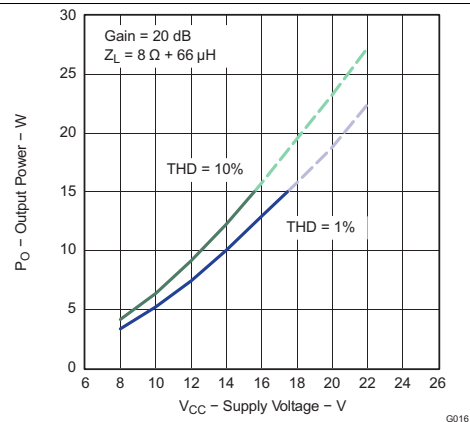
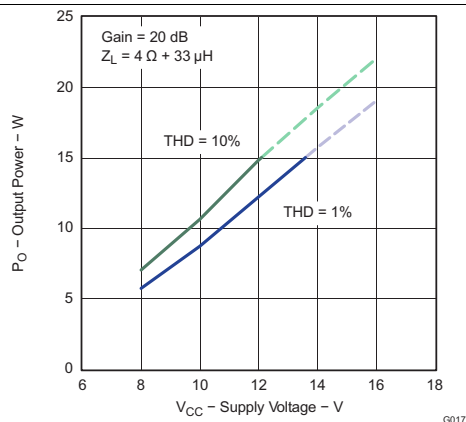

Figure 15. Gain/Phase vs Frequency (BTL)



Note: Dashed lines represent thermally limited regions.

Figure 16. Output Power vs Supply Voltage (BTL)



Note: Dashed lines represent thermally limited regions.

Figure 17. Output Power vs Supply Voltage (BTL)

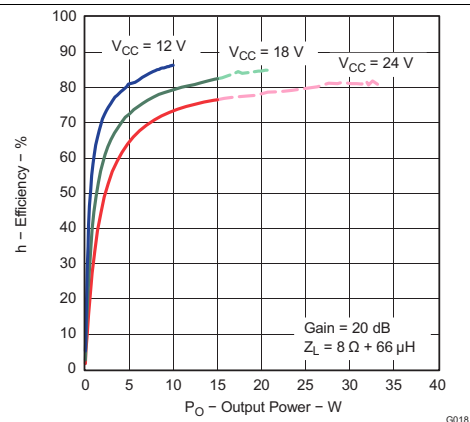

Note: Dashed lines represent thermally limited regions.

Figure 18. Efficiency vs Output Power (BTL)

Typical Characteristics (continued)

All measurements taken at 1 kHz, unless otherwise noted. The TPA3110D2-Q1 EVM (which is available at [ti.com](http://ti.com)) made the measurements.

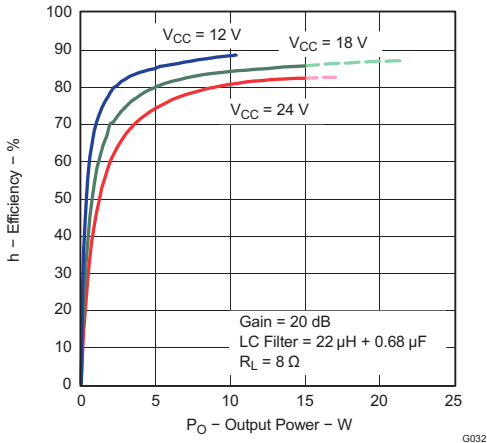
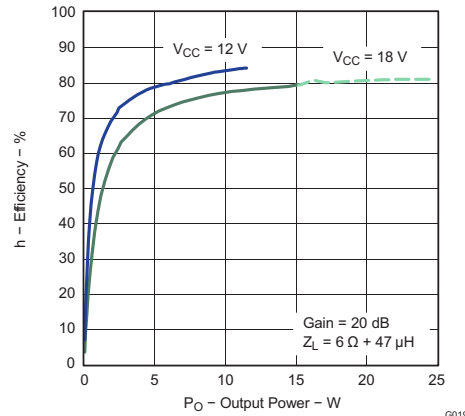

Figure 19. Efficiency vs Output Power (BTL With LC Filter)



Note: Dashed lines represent thermally limited regions.

Figure 20. Efficiency vs Output Power (BTL)

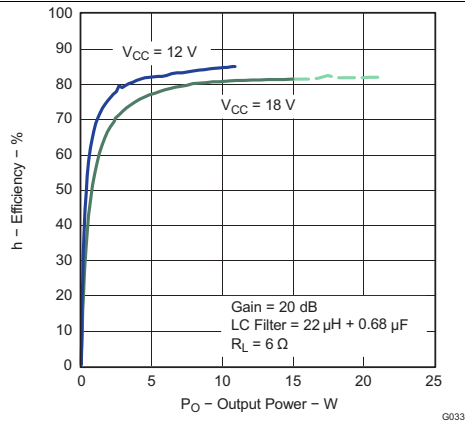

Figure 21. Efficiency vs Output Power (BTL With LC Filter)

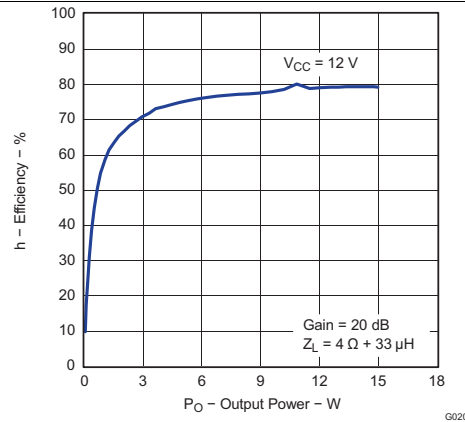

Figure 22. Efficiency vs Output Power (BTL)

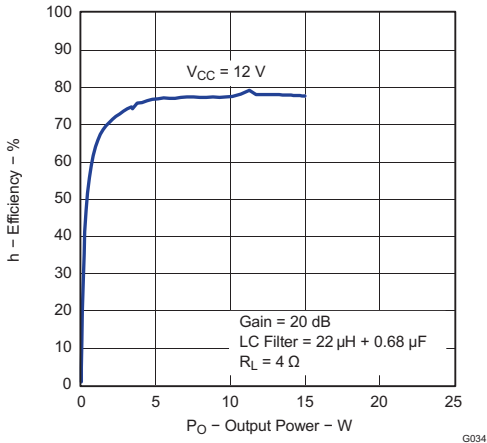
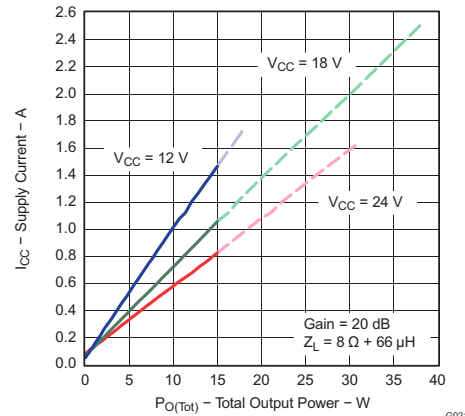

Figure 23. Efficiency vs Output Power (BTL With LC Filter)



Note: Dashed lines represent thermally limited regions.

Figure 24. Supply Current vs Total Output Power (BTL)

Typical Characteristics (continued)

All measurements taken at 1 kHz, unless otherwise noted. The TPA3110D2-Q1 EVM (which is available at [ti.com](http://ti.com)) made the measurements.

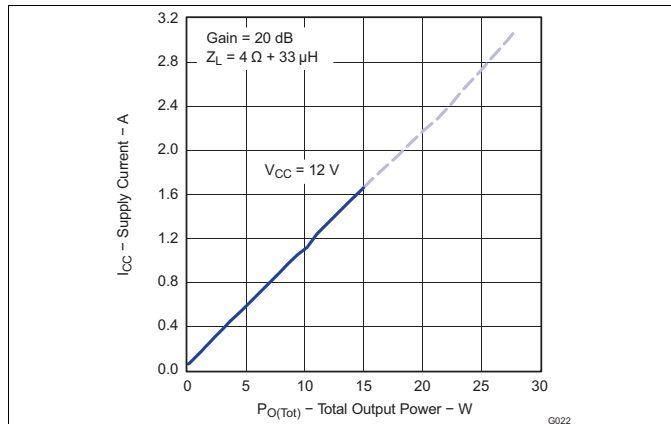

Note: Dashed lines represent thermally limited regions.

Figure 25. Supply Current vs Total Output Power (BTL)

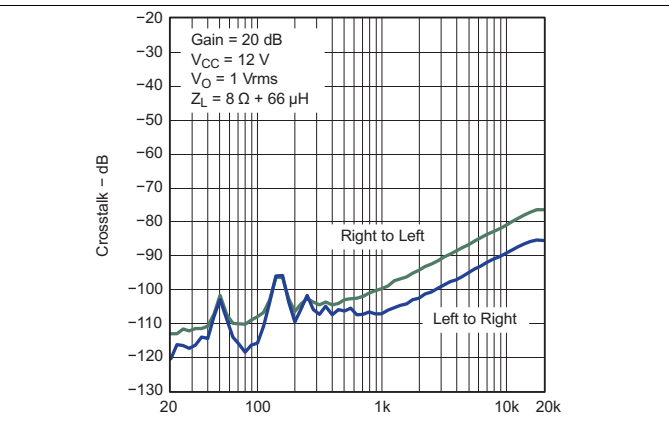

Figure 26. Crosstalk vs Frequency (BTL)

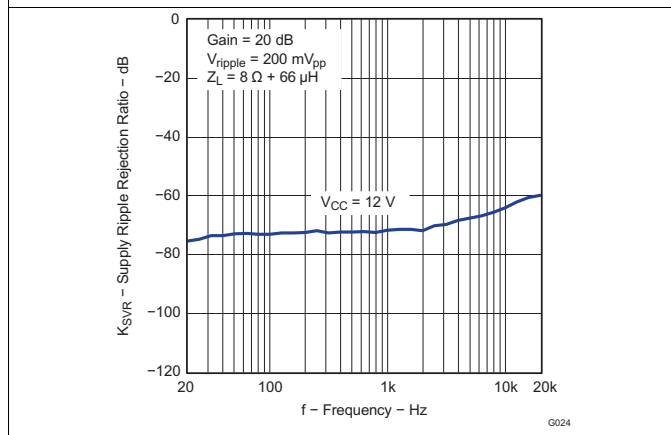

Figure 27. Supply Ripple Rejection Ratio vs Frequency (BTL)

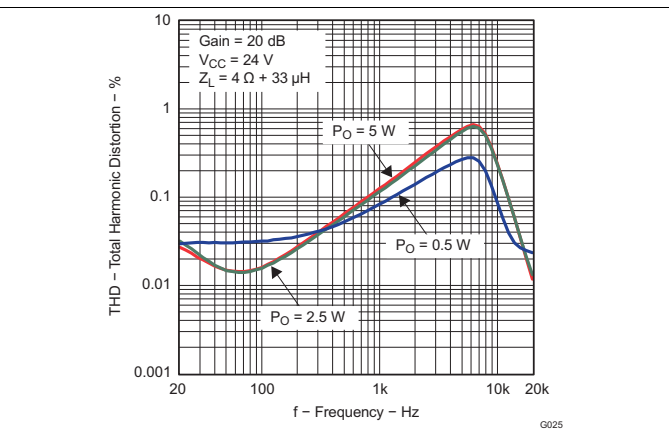

Figure 28. Total Harmonic Distortion vs Frequency (PBTL)

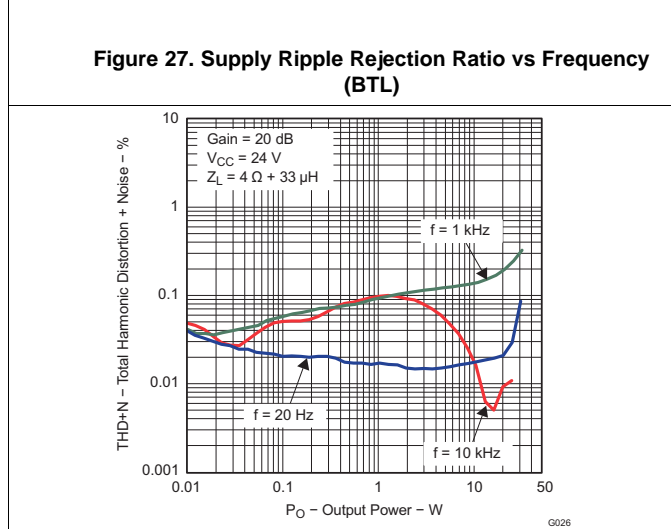

Figure 29. Total Harmonic Distortion + Noise vs Output Power (PBTL)

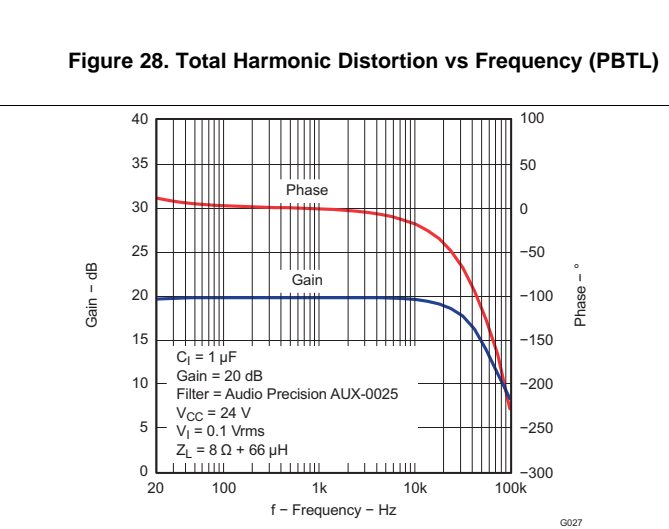
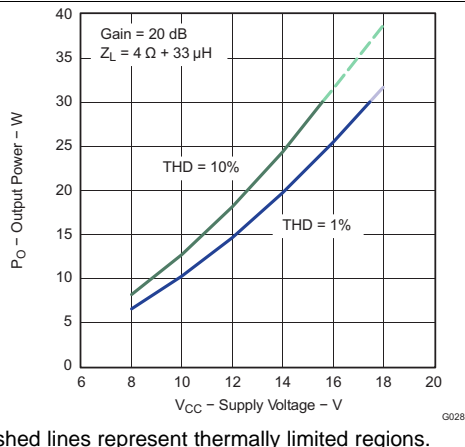

Figure 30. Gain/Phase vs Frequency (PBTL)

**Typical Characteristics (continued)**

All measurements taken at 1 kHz, unless otherwise noted. The TPA3110D2-Q1 EVM (which is available at [ti.com](http://ti.com)) made the measurements.



Note: Dashed lines represent thermally limited regions.

**Figure 31. Output Power vs Supply Voltage (PBTL)**

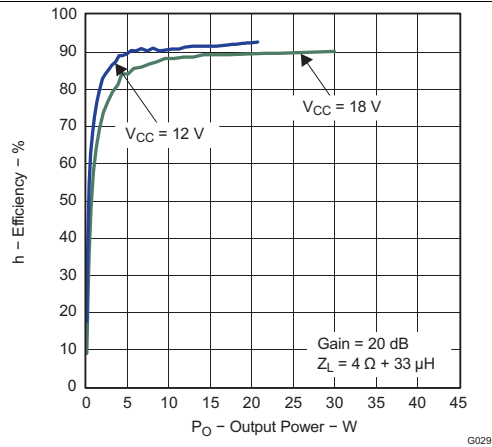

**Figure 32. Efficiency vs Output Power (PBTL)**

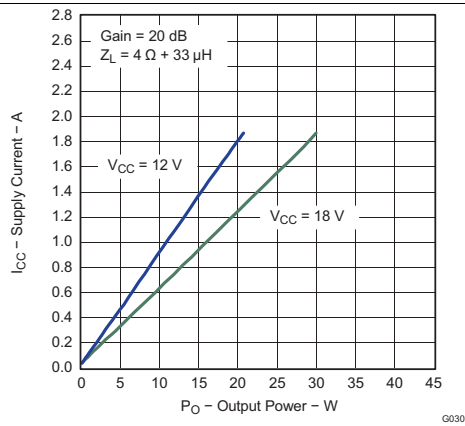

**Figure 33. Supply Current vs Output Power (PBTL)**

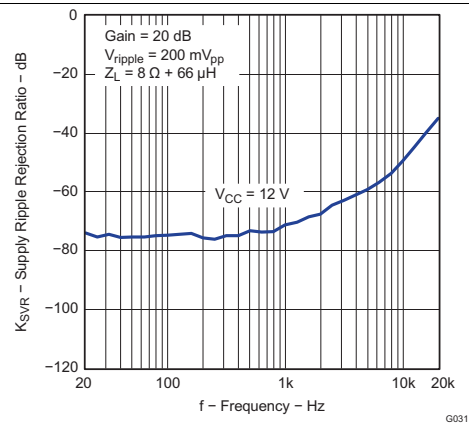

**Figure 34. Supply Ripple Rejection Ratio vs Frequency (PBTL)**

## 7 Detailed Description

### 7.1 Overview

The TPA3110D2-Q1 is AEC-Q100 qualified with a temperature grade 1 (-40°C to 125°C), HBM ESD classification level H2, and CDM ESD classification level C2. This automotive audio amplifier also features several protection mechanisms as follows:

- DC Current Detection
  - The TPA3110D2-Q1 protects speakers from DC current by reporting a fault on the  $\overline{\text{FAULT}}$  pin and turning the amplifier outputs to a Hi-Z state when a DC current is detected. The PVCC supply must be cycled to clear this fault.
- Short-Circuit Protection and Automatic Recovery
  - The TPA3110D2-Q1 has short circuit protection from the output pins to VCC, GND, or to each other. If a short circuit is detected, it will be reported on the  $\overline{\text{FAULT}}$  pin and the amplifier outputs will be switched to a Hi-Z state. The fault can be cleared by cycling the  $\overline{\text{SD}}$  pin.
- Thermal Protection
  - When the die temperature exceeds 150°C ( $\pm 15^\circ\text{C}$ ) the device enters the shutdown state and the amplifier outputs are disabled. The TPA3110D2-Q1 recovers automatically when the temperature decreases by 15°C

## 7.2 Functional Block Diagram

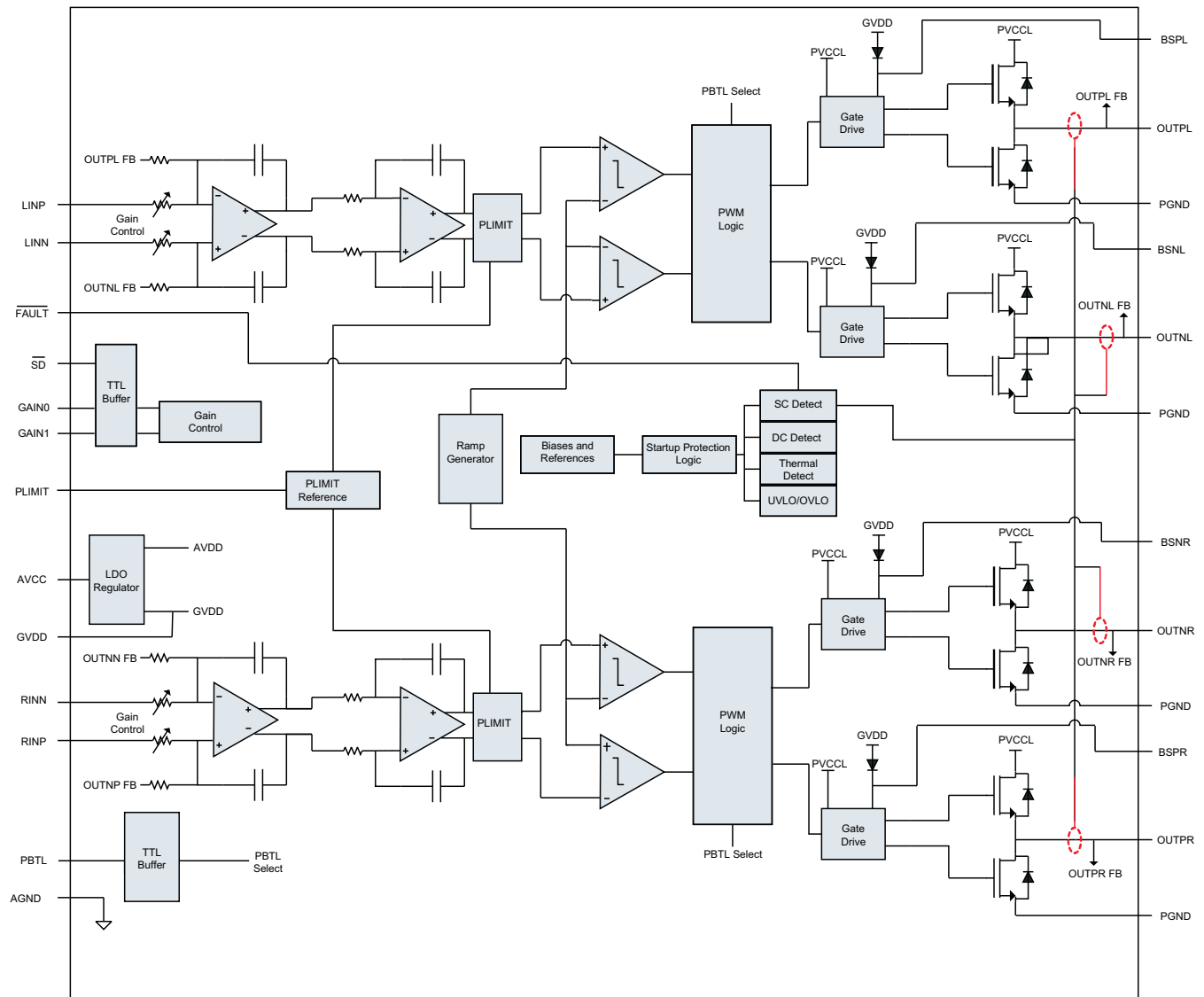

## 7.3 Feature Description

### 7.3.1 DC Detect

TPA3110D2-Q1 has circuitry which protects the speakers from DC current which might occur due to defective capacitors on the input or shorts on the printed circuit board at the inputs. A DC detect fault is reported on the  $\overline{\text{FAULT}}$  pin as a low state. The DC detect fault also causes the amplifier to shut down by changing the state of the outputs to Hi-Z. To clear the DC detect it is necessary to cycle the PVCC supply. Cycling  $\overline{\text{SD}}$  does NOT clear a DC detect fault.

A DC detect fault is issued when the output differential duty-cycle of either channel exceeds 14% (for example, 57%, -43%) for more than 420 msec at the same polarity. This feature protects the speaker from large DC currents or AC currents less than 2 Hz. To avoid nuisance faults due to the DC detect circuit, hold the  $\overline{\text{SD}}$  pin low at power-up until the signals at the inputs are stable. Also, take care to match the impedance seen at the positive and negative inputs to avoid nuisance DC detect faults.

The minimum differential input voltages required to trigger the DC detect are shown in [Table 1](#). The inputs must remain at or above the voltage listed in the table for more than 420 msec to trigger the DC detect.

**Table 1. DC Detect Threshold**

AV (dB)	V <sub>IN</sub> (mV, Differential)
20	112
26	56
32	28
36	17

### 7.3.2 Short-Circuit Protection and Automatic Recovery Feature

TPA3110D2-Q1 has protection from overcurrent conditions caused by a short circuit on the output stage. The short-circuit protection fault is reported on the  $\overline{\text{FAULT}}$  pin as a low state. The amplifier outputs are switched to a Hi-Z state when the short-circuit protection latch is engaged. The latch can be cleared by cycling the  $\overline{\text{SD}}$  pin through the low state.

If automatic recovery from the short-circuit protection latch is desired, connect the  $\overline{\text{FAULT}}$  pin directly to the  $\overline{\text{SD}}$  pin. This allows the  $\overline{\text{FAULT}}$  pin function to automatically drive the  $\overline{\text{SD}}$  pin low, which clears the short-circuit protection latch.

### 7.3.3 Thermal Protection

Thermal protection on the TPA3110D2-Q1 prevents damage to the device when the internal die temperature exceeds 150°C. There is a  $\pm 15^\circ\text{C}$  tolerance on this trip point from device to device. Once the die temperature exceeds the thermal set point, the device enters into the shutdown state and the outputs are disabled. This is not a latched fault. The thermal fault is cleared once the temperature of the die is reduced by 15°C. The device begins normal operation at this point with no external system interaction.

Thermal protection faults are NOT reported on the  $\overline{\text{FAULT}}$  terminal.

### 7.3.4 GVDD Supply

The GVDD supply is used to power the gates of the output full bridge transistors. It can also be used to supply the PLIMIT voltage divider circuit. Add a 1- $\mu\text{F}$  capacitor to ground at this pin.

## 7.4 Device Functional Modes

### 7.4.1 PBTL Select

Use the PBTL pin to select between PBTL mode when held high or BTL mode when held low. Connect the speaker between the right and left outputs, with the positive and negative output from each channel tied together.

### 7.4.2 Gain Setting Through GAIN0 and GAIN1 Inputs

The gain of the TPA3110D2-Q1 is set to one of four options by the state of the GAIN0 and GAIN1 pins. Changing the gain setting also changes the input impedance of the TPA3110D2-Q1.

Refer to [Table 2](#) for a list of the gain settings.

**Table 2. Gain Setting**

GAIN1	GAIN0	AMPLIFIER GAIN (dB)	INPUT IMPEDANCE (k $\Omega$ )
		TYP	TYP
0	0	20	60
0	1	26	30
1	0	32	15
1	1	36	9

### 7.4.3 $\overline{SD}$ Operation

The  $\overline{SD}$  pin can be used to enter the shutdown mode which mutes the amplifier and causes the TPA3110D2-Q1 to enter a low-current state. This mode can also be triggered to improve power-off pop performance.

### 7.4.4 PLIMIT

The PLIMIT pin limits the output peak-to-peak voltage based on the voltage supplied to the PLIMIT pin. The peak output voltage is limited to four times the voltage at the PLIMIT pin.

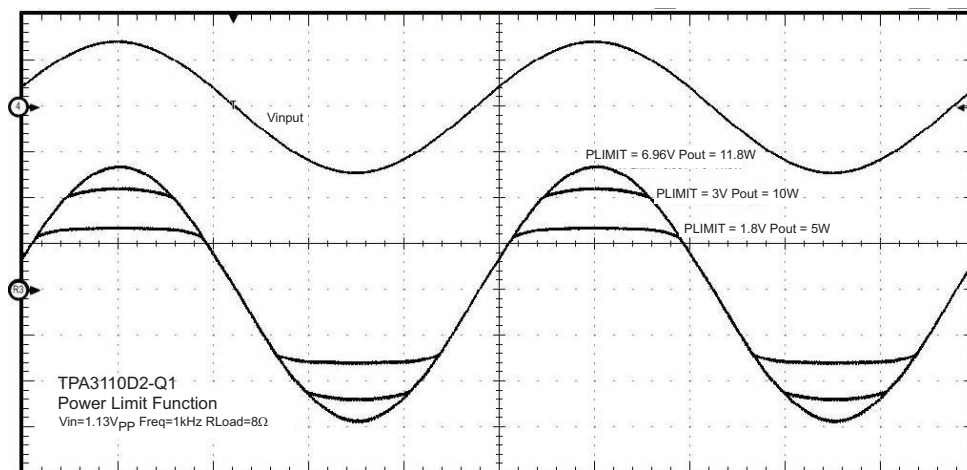

**Figure 35. PLIMIT Circuit Operation**

The PLIMIT circuit sets a limit on the output peak-to-peak voltage. The limiting is done by limiting the duty cycle to fixed maximum value. This limit can be thought of as a virtual voltage rail which is lower than the supply connected to PVCC. This virtual rail is four times the voltage at the PLIMIT pin. This output voltage can be used to calculate the maximum output power for a given maximum input voltage and speaker impedance.

$$P_{OUT} = \frac{\left( \left( \frac{R_L}{R_L + 2 \times R_S} \right) \times V_P \right)^2}{2 \times R_L} \quad \text{for unclipped power} \quad (1)$$

Where:

$R_S$  is the total series resistance including  $R_{DS(on)}$ , and any resistance in the output filter.

$R_L$  is the load resistance.

$V_P$  is the peak amplitude of the output possible within the supply rail.

$V_P = 4 \times \text{PLIMIT voltage if } \text{PLIMIT} < 4 \times V_P$

$P_{OUT} (10\% \text{THD}) = 1.25 \times P_{OUT} (\text{unclipped})$



**Table 3. PLIMIT Typical Operation**

TEST CONDITIONS	PLIMIT VOLTAGE	OUTPUT POWER (W)	Output Voltage Amplitude (V <sub>P-P</sub> )
PVCC = 24 V, V <sub>IN</sub> = 1 V <sub>RMS</sub> , R <sub>L</sub> = 8 Ω, Gain = 26 dB	6.97	36.1 (thermally limited)	43
PVCC = 24 V, V <sub>IN</sub> = 1 V <sub>RMS</sub> , R <sub>L</sub> = 8 Ω, Gain = 26 dB	2.94	15	25.2
PVCC = 24 V, V <sub>IN</sub> = 1 V <sub>RMS</sub> , R <sub>L</sub> = 8 Ω, Gain = 26 dB	2.34	10	20
PVCC = 24 V, V <sub>IN</sub> = 1 V <sub>RMS</sub> , R <sub>L</sub> = 8 Ω, Gain = 26 dB	1.62	5	14
PVCC = 24 V, V <sub>IN</sub> = 1 V <sub>RMS</sub> , R <sub>L</sub> = 8 Ω, Gain = 20 dB	6.97	12.1	27.7
PVCC = 24 V, V <sub>IN</sub> = 1 V <sub>RMS</sub> , R <sub>L</sub> = 8 Ω, Gain = 20 dB	3		23
PVCC = 24 V, V <sub>IN</sub> = 1 V <sub>RMS</sub> , R <sub>L</sub> = 8 Ω, Gain = 20 dB	1.86	5	14.8
PVCC = 12 V, V <sub>IN</sub> = 1 V <sub>RMS</sub> , R <sub>L</sub> = 8 Ω, Gain = 20 dB	6.97	10.55	23.5
PVCC = 12 V, V <sub>IN</sub> = 1 V <sub>RMS</sub> , R <sub>L</sub> = 8 Ω, Gain = 20 dB	1.76	5	15

## 8 Application and Implementation

### NOTE

Information in the following applications sections is not part of the TI component specification, and TI does not warrant its accuracy or completeness. TI's customers are responsible for determining suitability of components for their purposes. Customers should validate and test their design implementation to confirm system functionality.

### 8.1 Application Information

The TPA3110D1-Q1 device is an automotive class-D audio amplifier. It accepts either a stereo single ended or differential analog input, amplifies the signal, and drives up to 15W across two bridge tied loads, usually stereo speakers. Because an analog input is needed, this device is often paired with a codec or audio DAC if the audio source is digital.

The four digital input/output pins, GAIN0, GAIN1,  $\overline{SD}$ , and  $\overline{FAULT}$ , can be pulled up to PVCC. When connecting these terminals to PVCC, a 100 k $\Omega$ -resistor must be put in series to limit the slew rate. One of four gain settings is used depending on the configuration of GAIN0 and GAIN1. The  $\overline{SD}$  pin is used to put the device in shutdown or normal mode. The  $\overline{FAULT}$  pin is used to indicate if a DC detect or short circuit fault was detected. The next few sections explains design considerations and how to choose the external components.

### 8.2 Typical Application

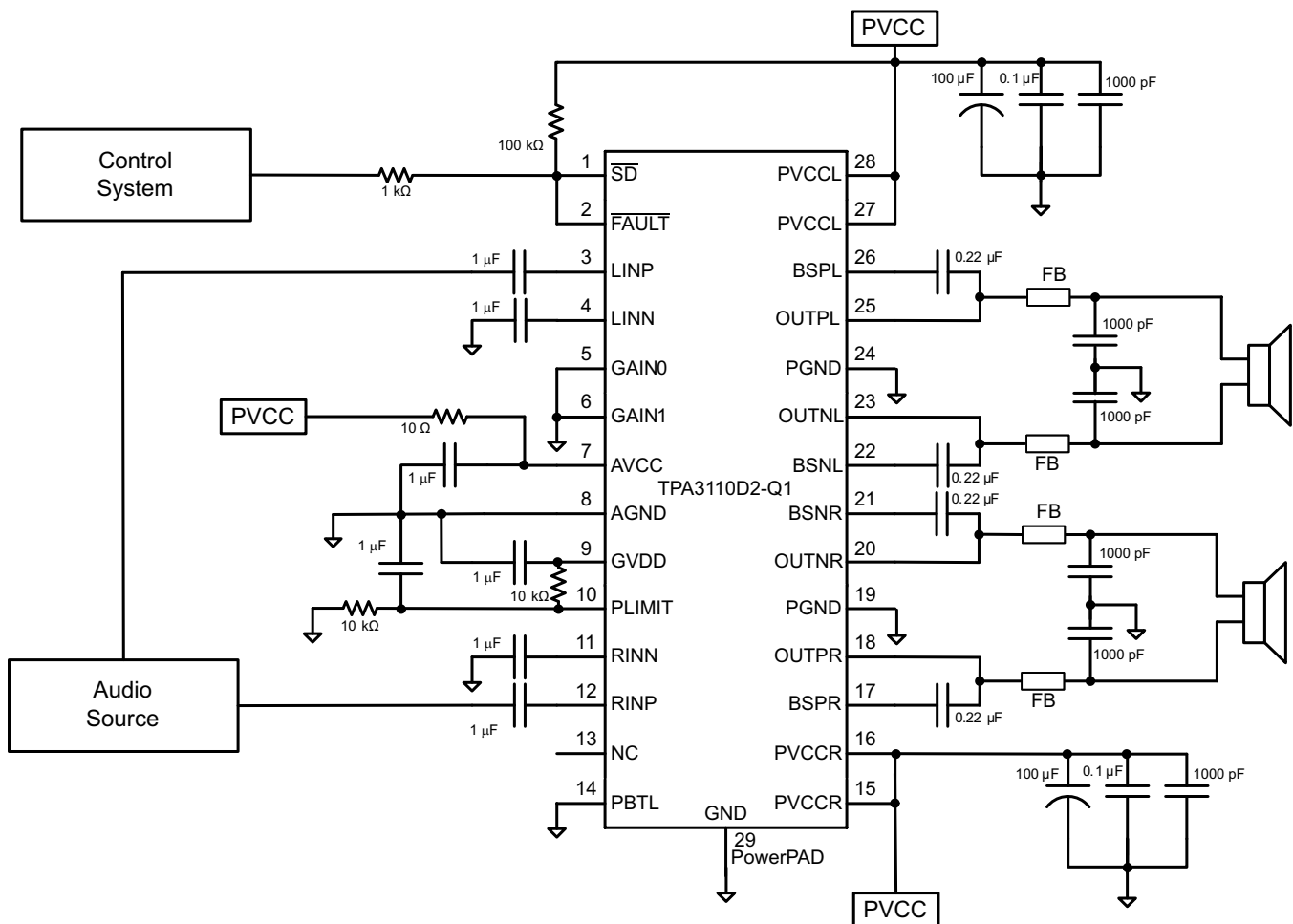
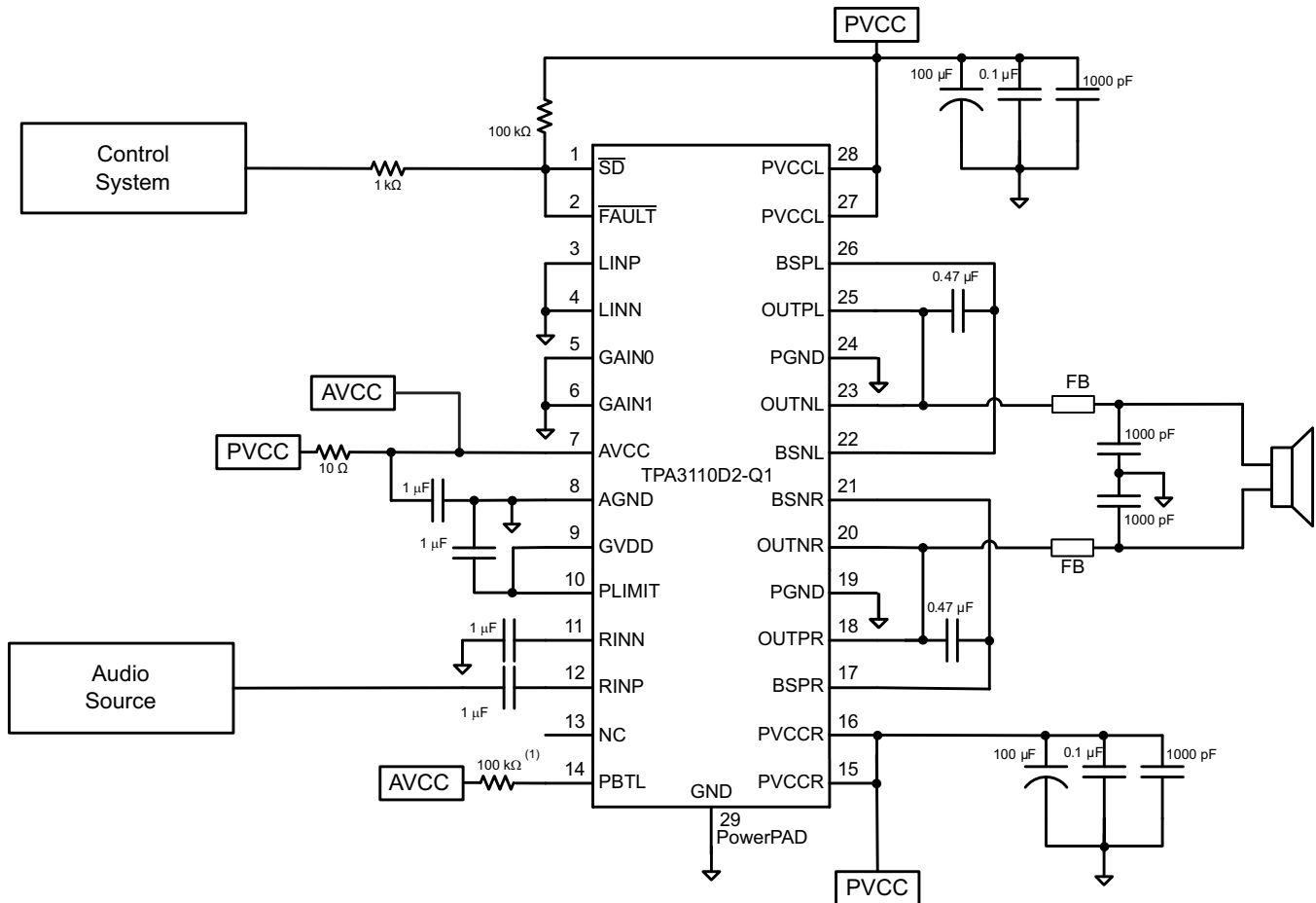

Figure 36. Stereo Class-D Amplifier With BTL Output and Single-Ended Inputs With Power Limiting

Typical Application (continued)



(1) A 100-kΩ resistor is needed if the PVCC slew rate is more than 10 V/ms.

Figure 37. Stereo Class-D Amplifier With PBTL Output and Single-Ended Input

8.2.1 Design Requirements

The typical requirements for designing the external components around the TPA3110D1-Q1 include efficiency and EMI/EMC performance. For most applications, only a ferrite bead is needed to filter unwanted emissions. The ripple current is low enough that an LC filter is typically not needed. As the output power increases, causing the ripple current to increase, an LC filter can be added to improve efficiency. An LC filter can also be added in cases where additional EMI suppression is needed.

In addition to discussing how to choose a ferrite bead and when to use an LC filter, the following sections also discuss the input filter and power supply decoupling. The input filter must be chosen with the input impedance of the amplifier in mind. The cut-off frequency should be chosen so that bass performance is not impacted. Power supply decoupling is important to ensure that noise from the power line does not impact the audio quality of the amplifier output.

## Typical Application (continued)

### 8.2.2 Detailed Design Procedure

#### 8.2.2.1 TPA3110D2-Q1 Modulation Scheme

The TPA3110D2-Q1 uses a modulation scheme that allows operation without the classic LC reconstruction filter when the amp is driving an inductive load. Each output is switching from 0 volts to the supply voltage. The OUP and OUTN are in phase with each other with no input so that there is little or no current in the speaker. The duty cycle of OUP is greater than 50% and OUTN is less than 50% for positive output voltages. The duty cycle of OUP is less than 50% and OUTN is greater than 50% for negative output voltages. The voltage across the load sits at 0 V throughout most of the switching period, reducing the switching current, which reduces any  $I^2R$  losses in the load.

See [Figure 42](#) for a plot of the output waveforms.

#### 8.2.2.2 Ferrite Bead Filter Considerations

Using the advanced emissions suppression technology in the TPA3110D2-Q1 amplifier, it is possible to design a high efficiency Class-D audio amplifier while minimizing interference to surrounding circuits. It is also possible to accomplish this with only a low-cost ferrite bead filter. In this case it is necessary to carefully select the ferrite bead used in the filter.

One important aspect of the ferrite bead selection is the type of material used in the ferrite bead. Not all ferrite material is alike, so it is important to select a material that is effective in the 10- to 100-MHz range which is key to the operation of the Class-D amplifier. Many of the specifications regulating consumer electronics have emissions limits as low as 30 MHz. It is important to use the ferrite bead filter to block radiation in the 30-MHz and above range from appearing on the speaker wires and the power supply lines which are good antennas for these signals. The impedance of the ferrite bead can be used along with a small capacitor with a value in the range of 1000 pF to reduce the frequency spectrum of the signal to an acceptable level. For best performance, the resonant frequency of the ferrite bead and capacitor filter should be less than 10 MHz.

Also, it is important that the ferrite bead is large enough to maintain its impedance at the peak currents expected for the amplifier. Some ferrite bead manufacturers specify the bead impedance at a variety of current levels. In this case it is possible to make sure the ferrite bead maintains an adequate amount of impedance at the peak current the amplifier sees. If these specifications are not available, it is also possible to estimate the bead current handling capability by measuring the resonant frequency of the filter output at low power and at maximum power. A change of resonant frequency of less than fifty percent under this condition is desirable. Examples of tested ferrite beads that work well with the TPA3110D2-Q1 include 28L0138-80R-10 and HI1812V101R-10 from Steward and the 742792510 from Würth Electronics.

A high quality ceramic capacitor is also needed for the ferrite bead filter. A low ESR capacitor with good temperature and voltage characteristics works best.

Additional EMC improvements may be obtained by adding snubber networks from each of the Class-D outputs to ground. Suggested values for a simple RC series snubber network would be 10  $\Omega$  in series with a 330-pF capacitor although design of the snubber network is specific to every application and must be designed taking into account the parasitic reactance of the printed circuit board as well as the audio amp. Take care to evaluate the stress on the component in the snubber network especially if the amp is running at high PVCC. Also, make sure the layout of the snubber network is tight and returns directly to the PGND or the PowerPAD™ integrated circuit package beneath the chip.

## Typical Application (continued)

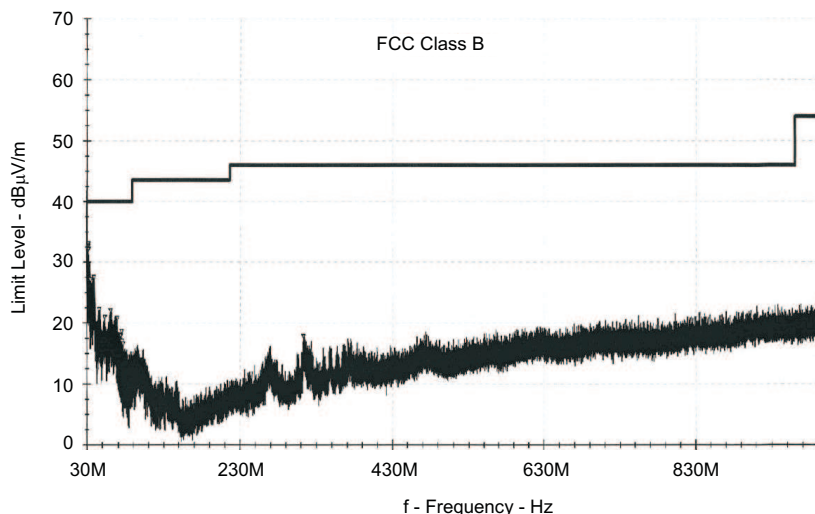

Figure 38. TPA3110D2-Q1 EMC Spectrum With FCC Class-B Limits

### 8.2.2.3 Efficiency: LC Filter Required With the Traditional Class-D Modulation Scheme

The main reason that the traditional Class-D amplifier needs an output filter is because the switching waveform results in maximum current flow. This causes more loss in the load, which causes lower efficiency. The ripple current is large for the traditional modulation scheme because the ripple current is proportional to voltage multiplied by the time at that voltage. The differential voltage swing is  $2 \times V_{CC}$ , and the time at each voltage is half the period for the traditional modulation scheme. An ideal LC Filter is needed to store the ripple current from each half cycle for the next half cycle, while any resistance causes power dissipation. The speaker is both resistive and reactive, whereas an LC Filter is almost purely reactive.

The TPA3110D2-Q1 modulation scheme has little loss in the load without a filter because the pulses are short and the change in voltage is  $V_{CC}$  instead of  $2 \times V_{CC}$ . As the output power increases, the pulses widen, making the ripple current larger. Ripple current could be filtered with an LC Filter for increased efficiency, but for most applications the filter is not needed.

An LC Filter with a cutoff frequency less than the Class-D switching frequency allows the switching current to flow through the filter instead of the load. The filter has less resistance but higher impedance at the switching frequency than the speaker, which results in less power dissipation, therefore increasing efficiency.

### 8.2.2.4 When to Use an Output Filter for EMI Suppression

The TPA3110D2-Q1 has been tested with a simple ferrite bead filter for a variety of applications including long speaker wires up to 125 cm and high power. The TPA3110D2-Q1 EVM passes FCC Class-B specifications under these conditions using twisted speaker wires. The size and type of ferrite bead can be selected to meet application requirements. Also, the filter capacitor can be increased if necessary with some impact on efficiency.

There may be a few circuit instances where it is necessary to add a complete LC reconstruction filter. These circumstances might occur if there are nearby circuits which are sensitive to noise. In these cases a classic second order Butterworth filter similar to those shown in the figures below can be used.

Some systems have little power supply decoupling from the AC line but are also subject to line conducted interference (LCI) regulations. These include systems powered by wall warts and power bricks. In these cases, the LC reconstruction filters can be the lowest cost means to pass LCI tests. Common mode chokes using low frequency ferrite material can also be effective at preventing line conducted interference.

Typical Application (continued)

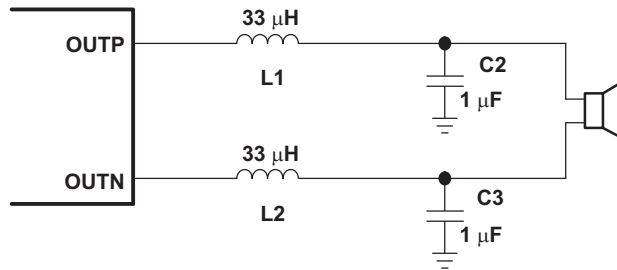

Figure 39. Typical LC Output Filter, Cutoff Frequency Of 27 kHz, Speaker Impedance = 8 Ω

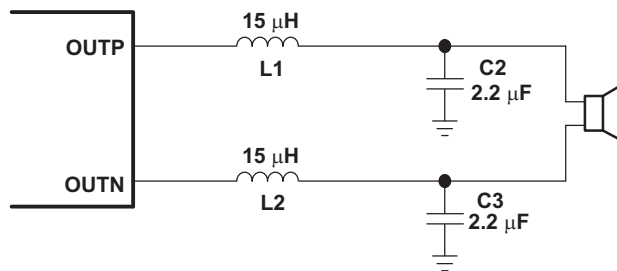

Figure 40. Typical LC Output Filter, Cutoff Frequency Of 27 kHz, Speaker Impedance = 4 Ω

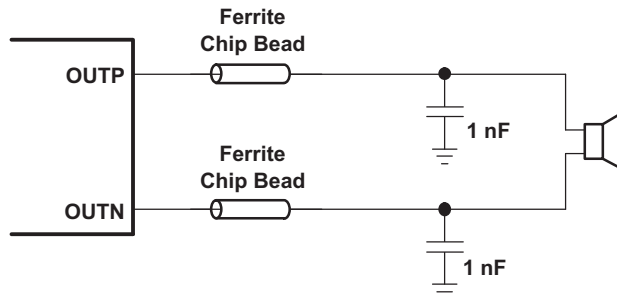
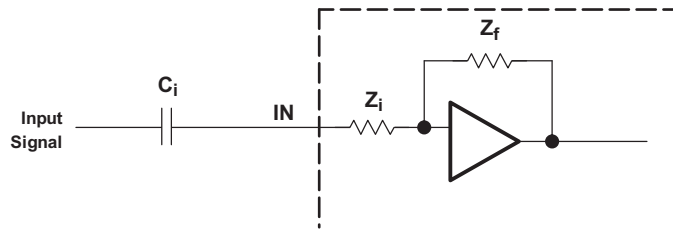

Figure 41. Typical Ferrite Chip Bead Filter (Chip Bead Example)

## Typical Application (continued)

### 8.2.2.5 Input Resistance

Changing the gain setting can vary the input resistance of the amplifier from its smallest value, 9 kΩ ±20%, to the largest value, 60 kΩ ±20%. As a result, if a single capacitor is used in the input high-pass filter, the –3 dB or cutoff frequency may change when changing gain steps.



The –3-dB frequency can be calculated using Equation 2. Use the Zi values given in Table 2.

$$f = \frac{1}{2\pi Z_i C_i} \quad (2)$$

### 8.2.2.6 Input Capacitor, Ci

In the typical application, an input capacitor (Ci) is required to allow the amplifier to bias the input signal to the proper DC level for optimum operation. In this case, Ci and the input impedance of the amplifier (Zi) form a high-pass filter with the corner frequency determined in Equation 3.

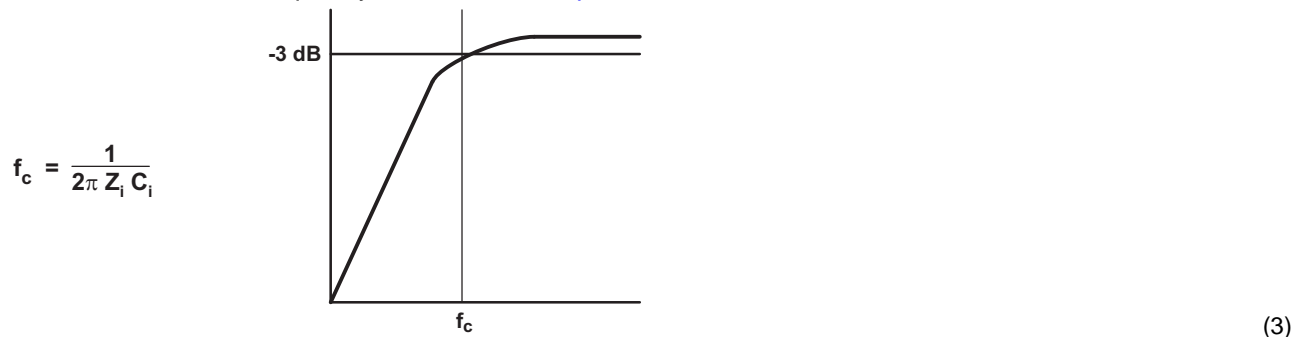

$$f_c = \frac{1}{2\pi Z_i C_i} \quad (3)$$

The value of Ci is important, as it directly affects the bass (low-frequency) performance of the circuit. Consider the example where Zi is 60 kΩ and the specification calls for a flat bass response down to 20 Hz. Equation 3 is reconfigured as Equation 4.

$$C_i = \frac{1}{2\pi Z_i f_c} \quad (4)$$

In this example, Ci is 0.13 μF; so, one would likely choose a value of 0.15 μF as this value is commonly used. If the gain is known and is constant, use Zi from Table 2 to calculate Ci. A further consideration for this capacitor is the leakage path from the input source through the input network (Ci) and the feedback network to the load. This leakage current creates a DC offset voltage at the input to the amplifier that reduces useful headroom, especially in high gain applications. For this reason, a low-leakage tantalum or ceramic capacitor is the best choice. When polarized capacitors are used, the positive side of the capacitor should face the amplifier input in most applications as the DC level there is held at 3 V, which is likely higher than the source DC level. Note that it is important to confirm the capacitor polarity in the application. Additionally, lead-free solder can create DC offset voltages and it is important to ensure that boards are cleaned properly.

### 8.2.2.7 BSN and BSP Capacitors

The full H-bridge output stages use only NMOS transistors. Therefore, they require bootstrap capacitors for the high side of each output to turn on correctly. A 0.22-μF ceramic capacitor, rated for at least 25 V, must be connected from each output to its corresponding bootstrap input. Specifically, one 0.22-μF capacitor must be connected from OUPx to BSPx, and one 0.22-μF capacitor must be connected from OUTNx to BSNx. (See the application circuit diagram in TPA3110D2-Q1 Simplified Application Schematic .)

## Typical Application (continued)

The bootstrap capacitors connected between the BSxx pins and corresponding output function as a floating power supply for the high-side N-channel power MOSFET gate drive circuitry. During each high-side switching cycle, the bootstrap capacitors hold the gate-to-source voltage high enough to keep the high-side MOSFETs turned on.

### 8.2.2.8 Differential Inputs

The differential input stage of the amplifier cancels any noise that appears on both input lines of the channel. To use the TPA3110D2-Q1 with a differential source, connect the positive lead of the audio source to the INP input and the negative lead from the audio source to the INN input. To use the TPA3110D2-Q1 with a single-ended source, AC-ground the INP or INN input through a capacitor equal in value to the input capacitor on INN or INP and apply the audio source to either input. In a single-ended input application, the unused input should be AC-grounded at the audio source instead of at the device input for best noise performance. For good transient performance, the impedance seen at each of the two differential inputs should be the same.

The impedance seen at the inputs should be limited to an RC time constant of 1 ms or less if possible. This is to allow the input DC blocking capacitors to become completely charged during the 14 ms power-up time. If the input capacitors are not allowed to completely charge, there will be some additional sensitivity to component matching which can result in pop if the input components are not well matched.

### 8.2.2.9 Using Low-ESR Capacitors

Low-ESR capacitors are recommended throughout this application section. A real (as opposed to ideal) capacitor can be modeled simply as a resistor in series with an ideal capacitor. The voltage drop across this resistor minimizes the beneficial effects of the capacitor in the circuit. The lower the equivalent value of this resistance, the more the real capacitor behaves like an ideal capacitor.

## 8.2.3 Application Curve

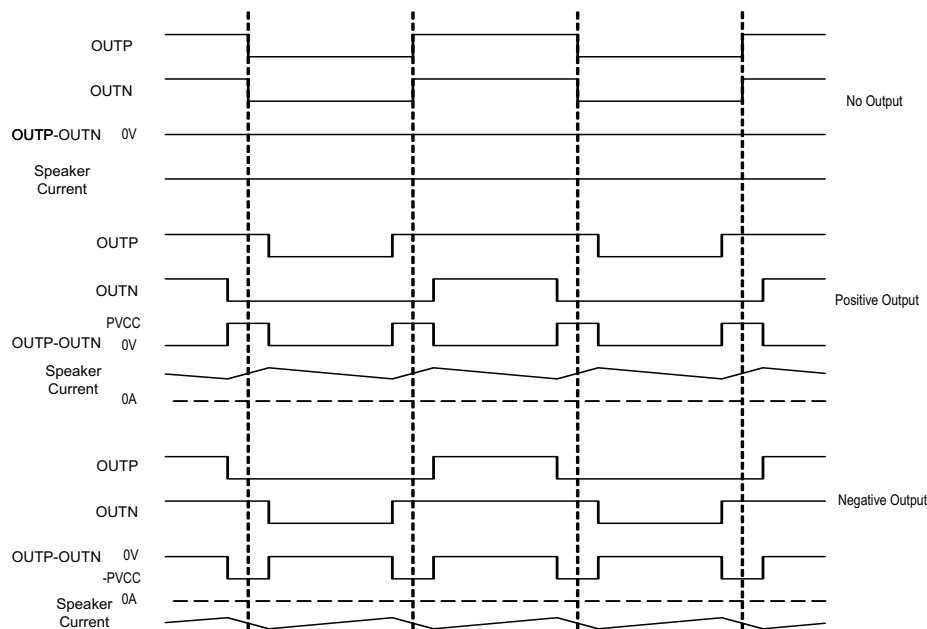

**Figure 42. The TPA3110D2-Q1 Output Voltage and Current Waveforms into an Inductive Load**



## 9 Power Supply Recommendations

The TPA3110D2-Q1 is a high-performance CMOS audio amplifier that requires adequate power supply decoupling to ensure that the output total harmonic distortion (THD) is as low as possible. Power supply decoupling also prevents oscillations for long lead lengths between the amplifier and the speaker.

Optimum decoupling is achieved by using a network of capacitors of different types that target specific types of noise on the power supply leads. For higher frequency transients due to parasitic circuit elements such as bond wire and copper trace inductances as well as lead frame capacitance, a good quality low equivalent-series-resistance (ESR) ceramic capacitor of value between 220 pF and 1000 pF works well. This capacitor should be placed as close to the device PVCC pins and system ground (either PGND pins or PowerPAD™ integrated circuit package) as possible. For mid-frequency noise due to filter resonances or PWM switching transients as well as digital hash on the line, another good quality capacitor typically 0.1  $\mu$ F to 1  $\mu$ F placed as close as possible to the device PVCC leads works best.

For filtering lower frequency noise signals, a larger aluminum electrolytic capacitor of 220  $\mu$ F or greater placed near the audio power amplifier is recommended. The 220- $\mu$ F capacitor also serves as a local storage capacitor for supplying current during large signal transients on the amplifier outputs. The PVCC terminals provide the power to the output transistors, so a 220- $\mu$ F or larger capacitor should be placed on each PVCC terminal. A 10- $\mu$ F capacitor on the AVCC terminal is adequate. Also, a small decoupling resistor between AVCC and PVCC can be used to keep high frequency Class-D noise from entering the linear input amplifiers.

## 10 Layout

### 10.1 Layout Guidelines

The TPA3110D2-Q1 can be used with a small, inexpensive ferrite bead output filter for most applications. However, since the Class-D switching edges are fast, it is necessary to take care when planning the layout of the printed circuit board. The following suggestions help to meet EMC requirements.

- Decoupling capacitors—The high-frequency decoupling capacitors should be placed as close to the PVCC and AVCC terminals as possible. Large (220- $\mu$ F or greater) bulk power supply decoupling capacitors should be placed near the TPA3110D2-Q1 on the PVCC and PVCCR supplies. Local, high-frequency bypass capacitors should be placed as close to the PVCC pins as possible. These caps can be connected to the thermal pad directly for an excellent ground connection. Consider adding a small, good quality low ESR ceramic capacitor between 220 pF and 1000 pF and a larger good quality mid-frequency cap of value between 0.1  $\mu$ F and 1  $\mu$ F to the PVCC connections at each end of the chip.
- Keep the current loop from each of the outputs through the ferrite bead and the small filter cap and back to PGND as small and tight as possible. The size of this current loop determines its effectiveness as an antenna.
- Grounding—The AVCC (pin 7) decoupling capacitor should be grounded to analog ground (AGND). The PVCC decoupling capacitors should connect to PGND. Analog ground and power ground should be connected at the thermal pad, which should be used as a central ground connection or star ground for the TPA3110D2-Q1.
- Output filter—The ferrite EMI filter ([Figure 41](#)) should be placed as close to the output terminals as possible for the best EMI performance. The LC Filter ([Figure 39](#) and [Figure 40](#)) should be placed close to the outputs. The capacitors used in both the ferrite and LC Filters should be grounded to power ground.
- Thermal pad—The thermal pad must be soldered to the PCB for proper thermal performance and optimal reliability. The dimensions of the thermal pad and thermal land should be 6.46 mm by 2.35 mm. Seven rows of solid vias (three vias per row, 0,3302 mm or 13 mils diameter) should be equally spaced underneath the thermal land. The vias should connect to a solid copper plane, either on an internal layer or on the bottom layer of the PCB. The vias must be solid vias, not thermal relief or webbed vias. See the TI Application Report [SLMA002](#) for more information about using the TSSOP thermal pad. For recommended PCB footprints, see the figures at the end of this data sheet.

For an example layout, see the TPA3110D2-Q1 Evaluation Module User's Guide, [SLOU263](#). Both the EVM user's guide and the thermal pad application report are available on the TI website at <http://www.ti.com>.

## 10.2 Layout Example

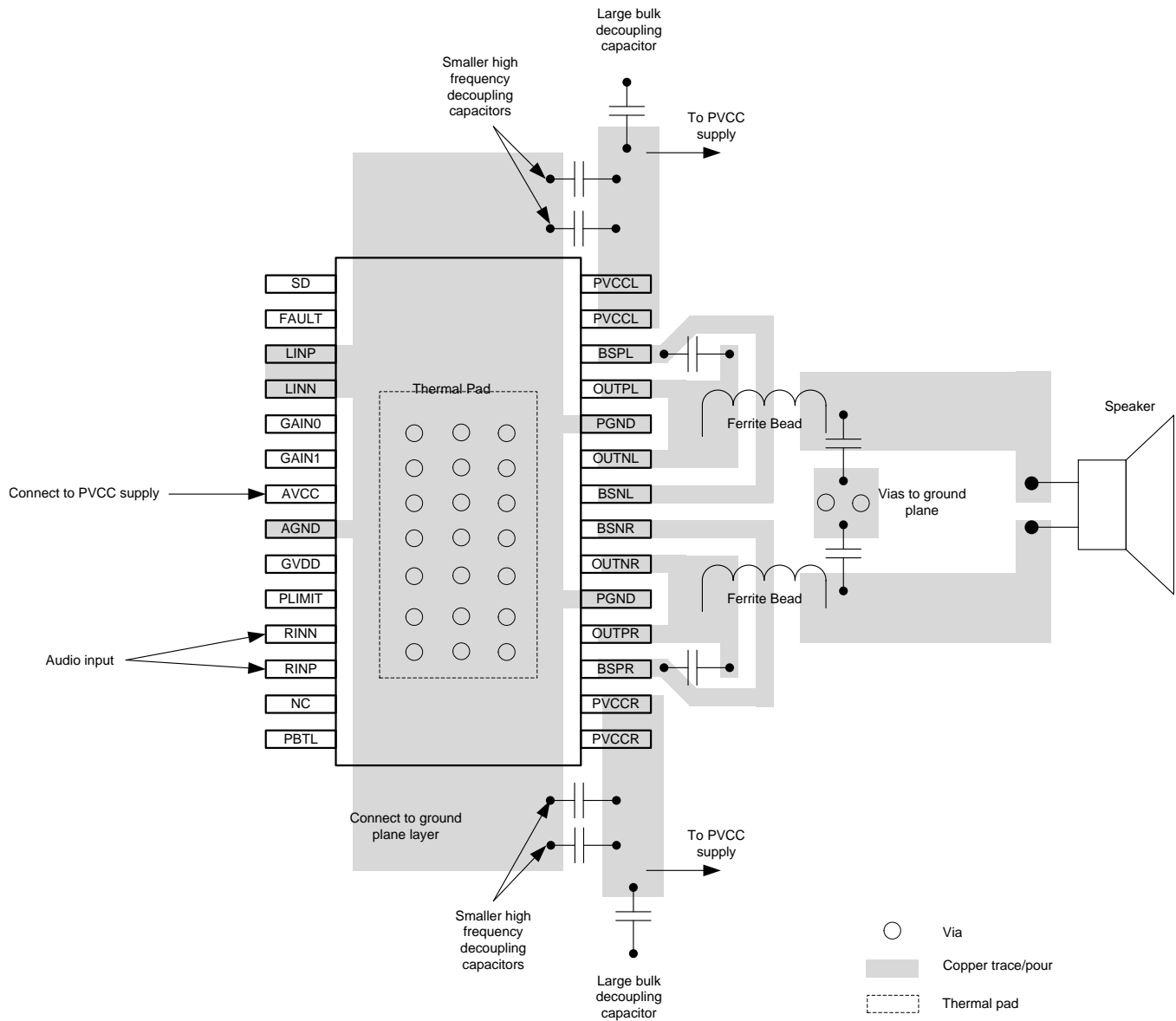

Figure 43. TPA3110D2-Q1 Layout Example for PBTL Output

## 11 Device and Documentation Support

### 11.1 Device Support

#### 11.1.1 Development Support

[TI PCB Thermal Calculator](#)

### 11.2 Documentation Support

#### 11.2.1 Related Documentation

For related documentation, see the following:

*Maximum Slew Rate on High-Voltage Pins for TPA3111D1*, [SLUA626](#)

*PowerPAD™ Thermally Enhanced Package*, [SLMA002](#)

*TPA3110D2-Q1 Evaluation Module User's Guide*, [SLOU263](#)

### 11.3 Community Resources

The following links connect to TI community resources. Linked contents are provided "AS IS" by the respective contributors. They do not constitute TI specifications and do not necessarily reflect TI's views; see TI's [Terms of Use](#).

**TI E2E™ Online Community** *TI's Engineer-to-Engineer (E2E) Community*. Created to foster collaboration among engineers. At [e2e.ti.com](#), you can ask questions, share knowledge, explore ideas and help solve problems with fellow engineers.

**Design Support** *TI's Design Support* Quickly find helpful E2E forums along with design support tools and contact information for technical support.

### 11.4 Trademarks

SpeakerGuard, PowerPAD, E2E are trademarks of Texas Instruments. All other trademarks are the property of their respective owners.

### 11.5 Electrostatic Discharge Caution



These devices have limited built-in ESD protection. The leads should be shorted together or the device placed in conductive foam during storage or handling to prevent electrostatic damage to the MOS gates.

### 11.6 Glossary

[SLYZ022](#) — *TI Glossary*.

This glossary lists and explains terms, acronyms, and definitions.

## 12 Mechanical, Packaging, and Orderable Information

The following pages include mechanical, packaging, and orderable information. This information is the most current data available for the designated devices. This data is subject to change without notice and revision of this document. For browser-based versions of this data sheet, refer to the left-hand navigation.

**PACKAGING INFORMATION**

Orderable Device	Status (1)	Package Type	Package Drawing	Pins	Package Qty	Eco Plan (2)	Lead/Ball Finish (6)	MSL Peak Temp (3)	Op Temp (°C)	Device Marking (4/5)	Samples
TPA3110D2QPWPRQ1	ACTIVE	HTSSOP	PWP	28	2000	Green (RoHS & no Sb/Br)	CU NIPDAU	Level-3-260C-168 HR	-40 to 125	TPA3110Q1	Samples

(1) The marketing status values are defined as follows:

**ACTIVE:** Product device recommended for new designs.

**LIFEBUY:** TI has announced that the device will be discontinued, and a lifetime-buy period is in effect.

**NRND:** Not recommended for new designs. Device is in production to support existing customers, but TI does not recommend using this part in a new design.

**PREVIEW:** Device has been announced but is not in production. Samples may or may not be available.

**OBSELETE:** TI has discontinued the production of the device.

(2) Eco Plan - The planned eco-friendly classification: Pb-Free (RoHS), Pb-Free (RoHS Exempt), or Green (RoHS & no Sb/Br) - please check <http://www.ti.com/productcontent> for the latest availability information and additional product content details.

**TBD:** The Pb-Free/Green conversion plan has not been defined.

**Pb-Free (RoHS):** TI's terms "Lead-Free" or "Pb-Free" mean semiconductor products that are compatible with the current RoHS requirements for all 6 substances, including the requirement that lead not exceed 0.1% by weight in homogeneous materials. Where designed to be soldered at high temperatures, TI Pb-Free products are suitable for use in specified lead-free processes.

**Pb-Free (RoHS Exempt):** This component has a RoHS exemption for either 1) lead-based flip-chip solder bumps used between the die and package, or 2) lead-based die adhesive used between the die and leadframe. The component is otherwise considered Pb-Free (RoHS compatible) as defined above.

**Green (RoHS & no Sb/Br):** TI defines "Green" to mean Pb-Free (RoHS compatible), and free of Bromine (Br) and Antimony (Sb) based flame retardants (Br or Sb do not exceed 0.1% by weight in homogeneous material)

(3) MSL, Peak Temp. - The Moisture Sensitivity Level rating according to the JEDEC industry standard classifications, and peak solder temperature.

(4) There may be additional marking, which relates to the logo, the lot trace code information, or the environmental category on the device.

(5) Multiple Device Markings will be inside parentheses. Only one Device Marking contained in parentheses and separated by a "~" will appear on a device. If a line is indented then it is a continuation of the previous line and the two combined represent the entire Device Marking for that device.

(6) Lead/Ball Finish - Orderable Devices may have multiple material finish options. Finish options are separated by a vertical ruled line. Lead/Ball Finish values may wrap to two lines if the finish value exceeds the maximum column width.

**Important Information and Disclaimer:** The information provided on this page represents TI's knowledge and belief as of the date that it is provided. TI bases its knowledge and belief on information provided by third parties, and makes no representation or warranty as to the accuracy of such information. Efforts are underway to better integrate information from third parties. TI has taken and continues to take reasonable steps to provide representative and accurate information but may not have conducted destructive testing or chemical analysis on incoming materials and chemicals. TI and TI suppliers consider certain information to be proprietary, and thus CAS numbers and other limited information may not be available for release.

In no event shall TI's liability arising out of such information exceed the total purchase price of the TI part(s) at issue in this document sold by TI to Customer on an annual basis.

**OTHER QUALIFIED VERSIONS OF TPA3110D2-Q1 :**

- Catalog: [TPA3110D2](#)

## NOTE: Qualified Version Definitions:

- Catalog - TI's standard catalog product

**TAPE AND REEL INFORMATION**

**QUADRANT ASSIGNMENTS FOR PIN 1 ORIENTATION IN TAPE**

\*All dimensions are nominal

Device	Package Type	Package Drawing	Pins	SPQ	Reel Diameter (mm)	Reel Width W1 (mm)	A0 (mm)	B0 (mm)	K0 (mm)	P1 (mm)	W (mm)	Pin1 Quadrant
TPA3110D2QPWPRQ1	HTSSOP	PWP	28	2000	330.0	16.4	6.9	10.2	1.8	12.0	16.0	Q1

TAPE AND REEL BOX DIMENSIONS



\*All dimensions are nominal

Device	Package Type	Package Drawing	Pins	SPQ	Length (mm)	Width (mm)	Height (mm)
TPA3110D2QPWRQ1	HTSSOP	PWP	28	2000	367.0	367.0	38.0



# MECHANICAL DATA

PWP (R-PDSO-G28)

PowerPAD™ PLASTIC SMALL OUTLINE

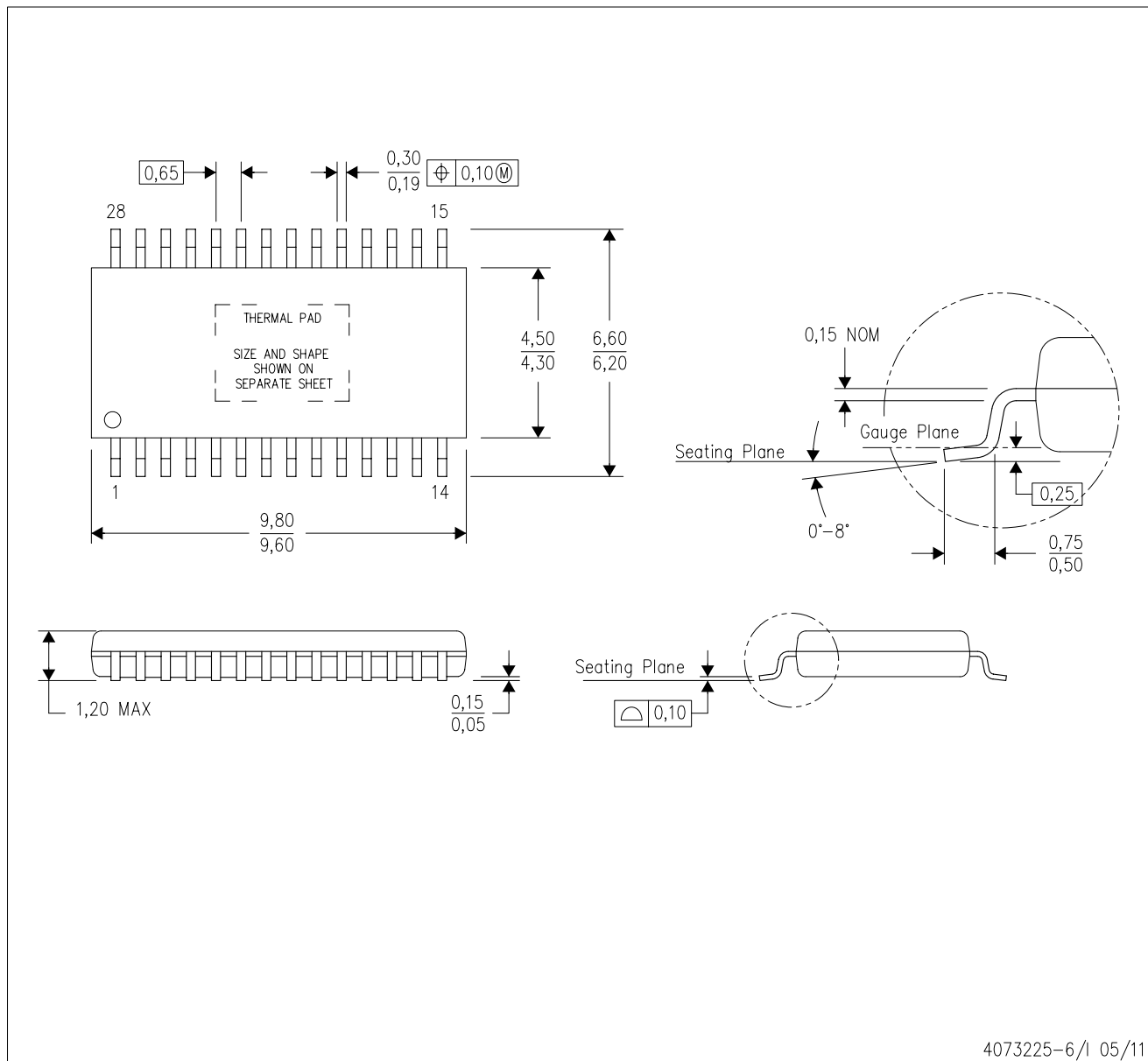

4073225-6/1 05/11

- NOTES:
- All linear dimensions are in millimeters.
  - This drawing is subject to change without notice.
  - Body dimensions do not include mold flash or protrusions. Mold flash and protrusion shall not exceed 0.15 per side.
  - This package is designed to be soldered to a thermal pad on the board. Refer to Technical Brief, PowerPad Thermally Enhanced Package, Texas Instruments Literature No. SLMA002 for information regarding recommended board layout. This document is available at [www.ti.com](http://www.ti.com) <<http://www.ti.com>>.
  - See the additional figure in the Product Data Sheet for details regarding the exposed thermal pad features and dimensions.
  - Falls within JEDEC MO-153

PowerPAD is a trademark of Texas Instruments.

# THERMAL PAD MECHANICAL DATA

## PWP (R-PDSO-G28) PowerPAD™ SMALL PLASTIC OUTLINE

### THERMAL INFORMATION

This PowerPAD™ package incorporates an exposed thermal pad that is designed to be attached to a printed circuit board (PCB). The thermal pad must be soldered directly to the PCB. After soldering, the PCB can be used as a heatsink. In addition, through the use of thermal vias, the thermal pad can be attached directly to the appropriate copper plane shown in the electrical schematic for the device, or alternatively, can be attached to a special heatsink structure designed into the PCB. This design optimizes the heat transfer from the integrated circuit (IC).

For additional information on the PowerPAD package and how to take advantage of its heat dissipating abilities, refer to Technical Brief, PowerPAD Thermally Enhanced Package, Texas Instruments Literature No. SLMA002 and Application Brief, PowerPAD Made Easy, Texas Instruments Literature No. SLMA004. Both documents are available at [www.ti.com](http://www.ti.com).

The exposed thermal pad dimensions for this package are shown in the following illustration.

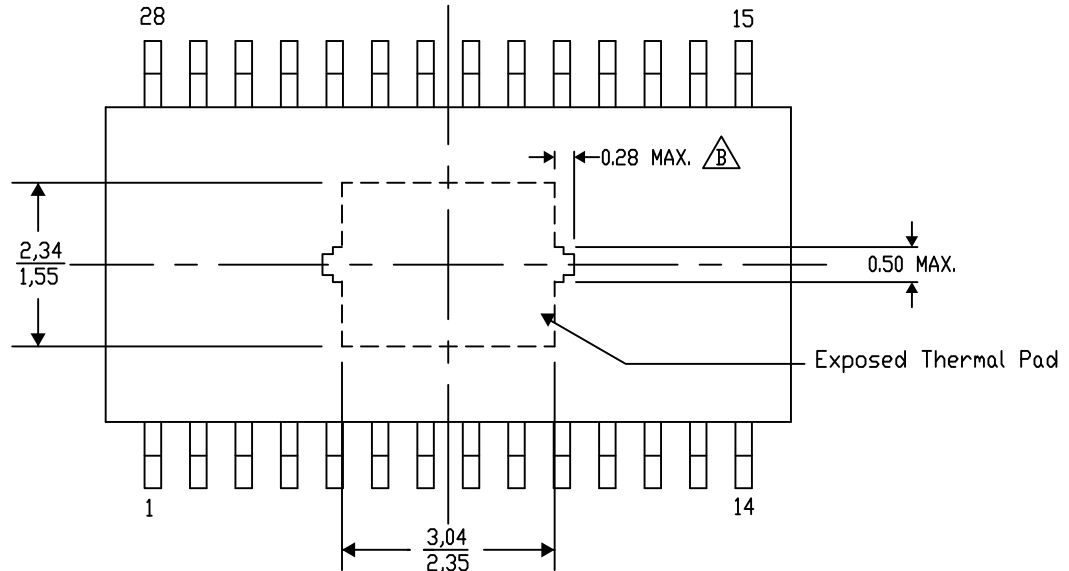

Exposed Thermal Pad Dimensions

4206332-39/AM 09/15

NOTE: A. All linear dimensions are in millimeters  
⚠ Exposed tie strap features may not be present.

PowerPAD is a trademark of Texas Instruments

PWP (R-PDSO-G28)

PowerPAD™ PLASTIC SMALL OUTLINE

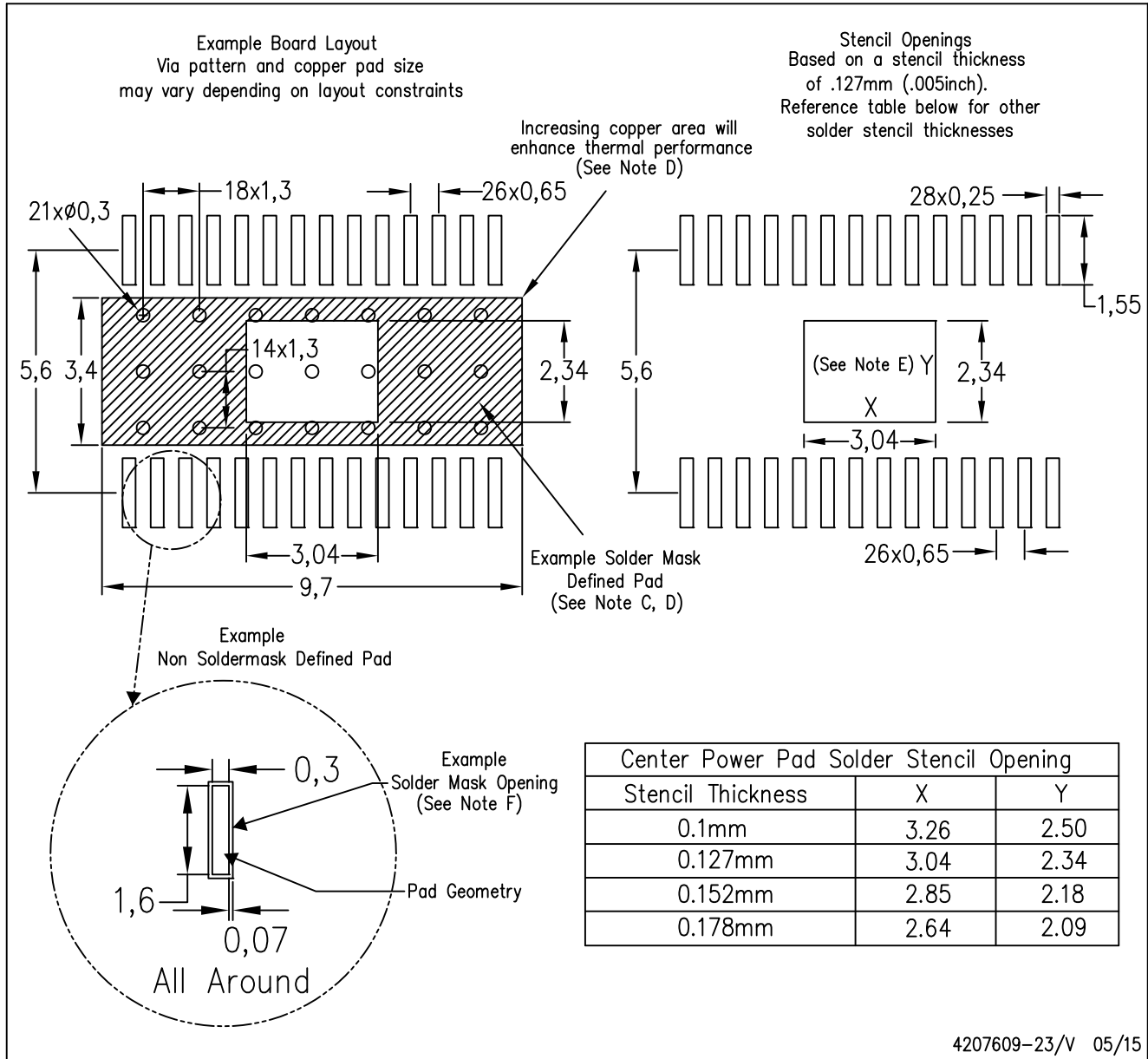

- NOTES:
- All linear dimensions are in millimeters.
  - This drawing is subject to change without notice.
  - Customers should place a note on the circuit board fabrication drawing not to alter the center solder mask defined pad.
  - This package is designed to be soldered to a thermal pad on the board. Refer to Technical Brief, PowerPad Thermally Enhanced Package, Texas Instruments Literature No. SLMA002, SLMA004, and also the Product Data Sheets for specific thermal information, via requirements, and recommended board layout. These documents are available at [www.ti.com](http://www.ti.com) <<http://www.ti.com>>. Publication IPC-7351 is recommended for alternate designs.
  - Laser cutting apertures with trapezoidal walls and also rounding corners will offer better paste release. Customers should contact their board assembly site for stencil design recommendations. Example stencil design based on a 50% volumetric metal load solder paste. Refer to IPC-7525 for other stencil recommendations.
  - Customers should contact their board fabrication site for solder mask tolerances between and around signal pads.

## IMPORTANT NOTICE

Texas Instruments Incorporated and its subsidiaries (TI) reserve the right to make corrections, enhancements, improvements and other changes to its semiconductor products and services per JESD46, latest issue, and to discontinue any product or service per JESD48, latest issue. Buyers should obtain the latest relevant information before placing orders and should verify that such information is current and complete. All semiconductor products (also referred to herein as "components") are sold subject to TI's terms and conditions of sale supplied at the time of order acknowledgment.

TI warrants performance of its components to the specifications applicable at the time of sale, in accordance with the warranty in TI's terms and conditions of sale of semiconductor products. Testing and other quality control techniques are used to the extent TI deems necessary to support this warranty. Except where mandated by applicable law, testing of all parameters of each component is not necessarily performed.

TI assumes no liability for applications assistance or the design of Buyers' products. Buyers are responsible for their products and applications using TI components. To minimize the risks associated with Buyers' products and applications, Buyers should provide adequate design and operating safeguards.

TI does not warrant or represent that any license, either express or implied, is granted under any patent right, copyright, mask work right, or other intellectual property right relating to any combination, machine, or process in which TI components or services are used. Information published by TI regarding third-party products or services does not constitute a license to use such products or services or a warranty or endorsement thereof. Use of such information may require a license from a third party under the patents or other intellectual property of the third party, or a license from TI under the patents or other intellectual property of TI.

Reproduction of significant portions of TI information in TI data books or data sheets is permissible only if reproduction is without alteration and is accompanied by all associated warranties, conditions, limitations, and notices. TI is not responsible or liable for such altered documentation. Information of third parties may be subject to additional restrictions.

Resale of TI components or services with statements different from or beyond the parameters stated by TI for that component or service voids all express and any implied warranties for the associated TI component or service and is an unfair and deceptive business practice. TI is not responsible or liable for any such statements.

Buyer acknowledges and agrees that it is solely responsible for compliance with all legal, regulatory and safety-related requirements concerning its products, and any use of TI components in its applications, notwithstanding any applications-related information or support that may be provided by TI. Buyer represents and agrees that it has all the necessary expertise to create and implement safeguards which anticipate dangerous consequences of failures, monitor failures and their consequences, lessen the likelihood of failures that might cause harm and take appropriate remedial actions. Buyer will fully indemnify TI and its representatives against any damages arising out of the use of any TI components in safety-critical applications.

In some cases, TI components may be promoted specifically to facilitate safety-related applications. With such components, TI's goal is to help enable customers to design and create their own end-product solutions that meet applicable functional safety standards and requirements. Nonetheless, such components are subject to these terms.

No TI components are authorized for use in FDA Class III (or similar life-critical medical equipment) unless authorized officers of the parties have executed a special agreement specifically governing such use.

Only those TI components which TI has specifically designated as military grade or "enhanced plastic" are designed and intended for use in military/aerospace applications or environments. Buyer acknowledges and agrees that any military or aerospace use of TI components which have **not** been so designated is solely at the Buyer's risk, and that Buyer is solely responsible for compliance with all legal and regulatory requirements in connection with such use.

TI has specifically designated certain components as meeting ISO/TS16949 requirements, mainly for automotive use. In any case of use of non-designated products, TI will not be responsible for any failure to meet ISO/TS16949.

### Products

Audio	<a href="http://www.ti.com/audio">www.ti.com/audio</a>
Amplifiers	<a href="http://amplifier.ti.com">amplifier.ti.com</a>
Data Converters	<a href="http://dataconverter.ti.com">dataconverter.ti.com</a>
DLP® Products	<a href="http://www.dlp.com">www.dlp.com</a>
DSP	<a href="http://dsp.ti.com">dsp.ti.com</a>
Clocks and Timers	<a href="http://www.ti.com/clocks">www.ti.com/clocks</a>
Interface	<a href="http://interface.ti.com">interface.ti.com</a>
Logic	<a href="http://logic.ti.com">logic.ti.com</a>
Power Mgmt	<a href="http://power.ti.com">power.ti.com</a>
Microcontrollers	<a href="http://microcontroller.ti.com">microcontroller.ti.com</a>
RFID	<a href="http://www.ti-rfid.com">www.ti-rfid.com</a>
OMAP Applications Processors	<a href="http://www.ti.com/omap">www.ti.com/omap</a>
Wireless Connectivity	<a href="http://www.ti.com/wirelessconnectivity">www.ti.com/wirelessconnectivity</a>

### Applications

Automotive and Transportation	<a href="http://www.ti.com/automotive">www.ti.com/automotive</a>
Communications and Telecom	<a href="http://www.ti.com/communications">www.ti.com/communications</a>
Computers and Peripherals	<a href="http://www.ti.com/computers">www.ti.com/computers</a>
Consumer Electronics	<a href="http://www.ti.com/consumer-apps">www.ti.com/consumer-apps</a>
Energy and Lighting	<a href="http://www.ti.com/energy">www.ti.com/energy</a>
Industrial	<a href="http://www.ti.com/industrial">www.ti.com/industrial</a>
Medical	<a href="http://www.ti.com/medical">www.ti.com/medical</a>
Security	<a href="http://www.ti.com/security">www.ti.com/security</a>
Space, Avionics and Defense	<a href="http://www.ti.com/space-avionics-defense">www.ti.com/space-avionics-defense</a>
Video and Imaging	<a href="http://www.ti.com/video">www.ti.com/video</a>

### TI E2E Community

[e2e.ti.com](http://e2e.ti.com)