

# BL05 - 1211

The BL05 - 1211 is a LED of 650nm wavelength using four elements (AlGaInP). Our original LED processing technology made it possible to increase the electric current density at the emission point. The luminous strength of single light source per unit surface is now more than ten times higher than before.

**FEATURES**

- High brightness
- The Optical axis match is easy because of red luminance.
- Optical design is easy because of the point light of  $\varnothing 50\mu\text{m}$

**APPLICATIONS**

- Source of light for optical switch , optical fiber , and scanner
- Source of light for optical sensor parallel light
- Source of light for various , precise measurements

**DIMENSIONS**

(Unit : mm)

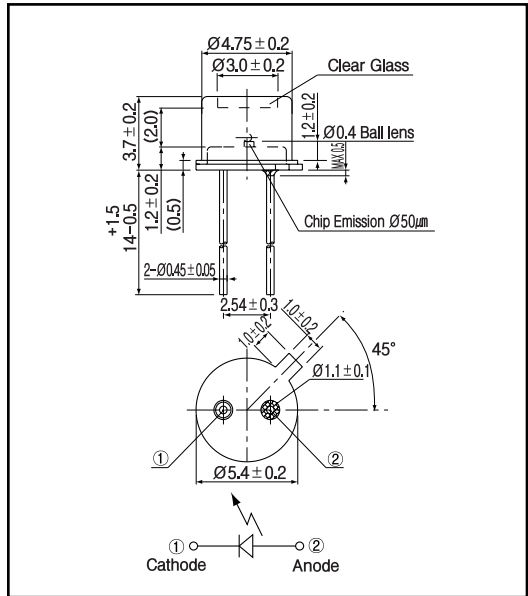

**MAXIMUM RATINGS**

(Ta=25 )

Item	Symbol	Rating	Unit
Reverse voltage	$V_R$	3	V
Forward current	$I_F$	20	mA
Power dissipation	$P_D$	50	mW
Pulse forward current <sup>*1</sup>	$I_{FP}$	150	mA
Operating temp.	$T_{opr.}$	- 30 + 85	
Storage temp.	$T_{stg.}$	- 40 + 100	
Soldering temp. <sup>*2</sup>	$T_{sol.}$	260	

\*1. pulse width :  $t_w \leq 10 \mu\text{sec}$ , period :  $T = 1 \text{ msec}$ .

\*2. For MAX.5 seconds at the position of 2 mm from the package

**ELECTRO-OPTICAL CHARACTERISTICS**

(Ta=25 )

Item	Symbol	Conditions	Min.	Typ.	Max.	Unit.
Forward voltage	$V_F$	$I_F = 20 \text{ mA}$		2.0	3.0	V
Reverse current	$I_R$	$V_R = 3 \text{ V}$			10	$\mu\text{A}$
Radiant intensity	$P_c(\text{W})$	$I_F = 20 \text{ mA}$		0.3		mW
Peak emission wavelength	$\lambda_p$	$I_F = 20 \text{ mA}$		650		nm
Spectral bandwidth 50%		$I_F = 20 \text{ mA}$		30		nm
Half angle		$I_F = 20 \text{ mA}$		$\pm 7$		deg.

**Pin-Point LED(AlGaInP)**

**BL05 - 1211**

**Power dissipation Vs. Ambient temperature**

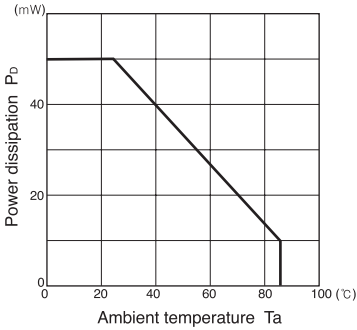

**Radiant intensity Vs. Forward current**

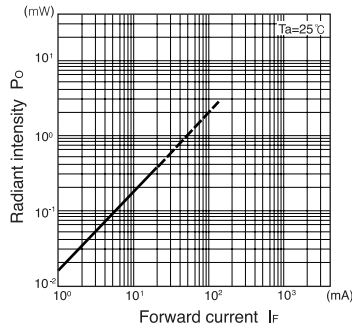

**Relative radiant intensity Vs. Ambient temperature**

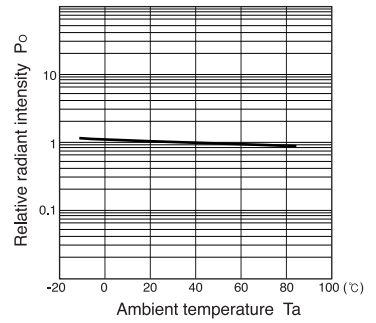

**Relative intensity Vs. Wavelength**

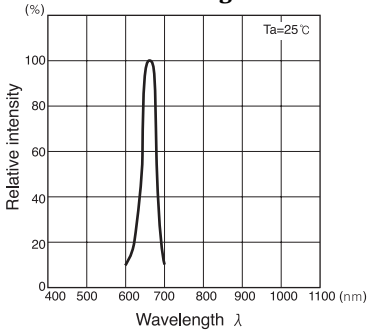

**Forward current Vs. Forward voltage**

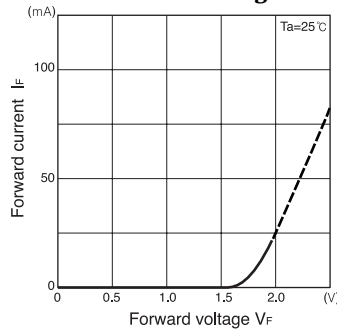

**Radiant Pattern**

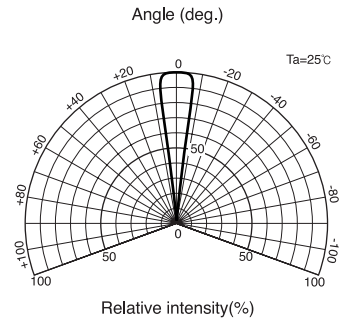

**Relative radiant intensity Vs. Distance**

