

P-Channel Logic Level Enhancement Mode Power MOSFET

MTB25P06FP

BV_{DSS}	-60V
I_D	-52A
R_{DS(ON)}@ V_{GS}=-10V, I_D=-20A	18.8mΩ (typ)
R_{DS(ON)}@ V_{GS}=-4.5V, I_D=-20A	21.8mΩ (typ)

Features

- Low Gate Charge
- Simple Drive Requirement
- Pb-free lead plating package

Equivalent Circuit

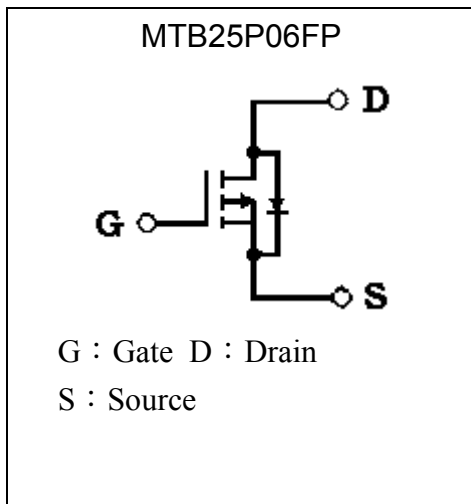

Outline

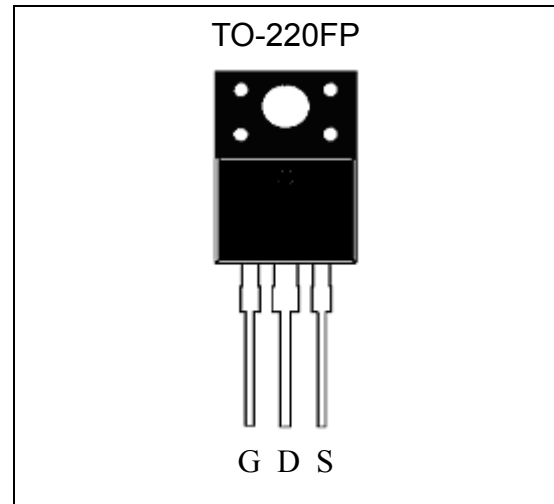

Ordering Information

Device	Package	Shipping
MTB25P06FP-0-UB-S	TO-220FP (RoHS compliant package)	50 pcs/tube, 20 tubes/box, 4 boxes / carton

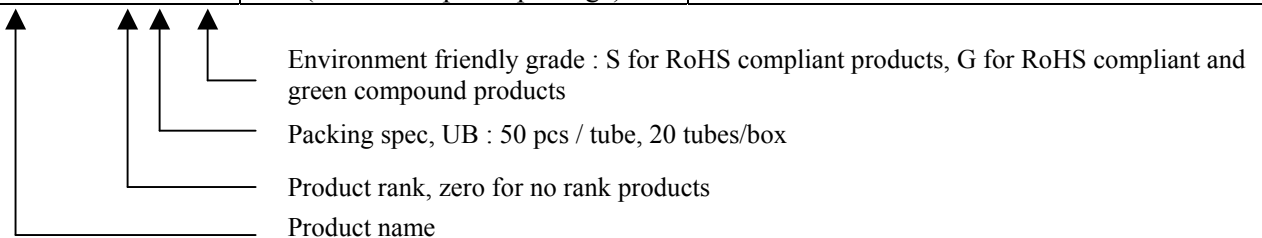

**Absolute Maximum Ratings** ($T_C=25^{\circ}\text{C}$, unless otherwise noted)

Parameter	Symbol	Limits	Unit	
Drain-Source Voltage	V_{DS}	-60	V	
Gate-Source Voltage	V_{GS}	± 20		
Continuous Drain Current @ $T_C=25^{\circ}\text{C}$, $V_{GS}=10\text{V}$ (Note 1)	I_D	-52	A	
Continuous Drain Current @ $T_C=100^{\circ}\text{C}$, $V_{GS}=10\text{V}$ (Note 1)		-37		
Continuous Drain Current @ $T_A=25^{\circ}\text{C}$, $V_{GS}=10\text{V}$	I_{DSM}	-7.5		
Continuous Drain Current @ $T_A=70^{\circ}\text{C}$, $V_{GS}=10\text{V}$		-6.0		
Pulsed Drain Current (Note 3)	I_{DM}	-130		
Avalanche Current (Note 3)	I_{AS}	-66		
Avalanche Energy @ $L=0.1\text{mH}$, $I_D=-66\text{A}$, $R_G=25\ \Omega$ (Note 2)	E_{AS}	218	mJ	
Repetitive Avalanche Energy @ $L=0.05\text{mH}$ (Note 3)	E_{AR}	10		
Total Power Dissipation	P_D	$T_C=25^{\circ}\text{C}$ (Note 1)	100	W
		$T_C=100^{\circ}\text{C}$ (Note 1)	50	
	P_{DSM}	$T_A=25^{\circ}\text{C}$	2	
		$T_A=70^{\circ}\text{C}$	1.3	
Operating Junction and Storage Temperature Range	T_J, T_{stg}	-55~+175	$^{\circ}\text{C}$	

Thermal Data

Parameter	Symbol	Value	Unit
Thermal Resistance, Junction-to-case, max	$R_{th,j-c}$	1.5	$^{\circ}\text{C}/\text{W}$
Thermal Resistance, Junction-to-ambient, max	$R_{th,j-a}$	62.5	$^{\circ}\text{C}/\text{W}$

- Note : 1. The power dissipation P_D is based on $T_{J(MAX)}=175^{\circ}\text{C}$, using junction-to-case thermal resistance, and is more useful in setting the upper dissipation limit for cases where additional heatsinking is used.
2. The power dissipation P_{DSM} is based on $R_{\theta JA}$ and the maximum allowed junction temperature of 150°C . The value in any given application depends on the user's specific board design.
3. Repetitive rating, pulse width limited by junction temperature $T_{J(MAX)}=175^{\circ}\text{C}$. Ratings are based on low frequency and low duty cycles to keep initial $T_J=25^{\circ}\text{C}$.



Characteristics (Tc=25°C, unless otherwise specified)

Symbol	Min.	Typ.	Max.	Unit	Test Conditions
Static					
BV _{DSS}	-60	-	-	V	V _{GS} =0V, I _D =-250μA
V _{GS(th)}	-0.8	-1.1	-2.5		V _{DS} =V _{GS} , I _D =-250μA
I _{GSS}	-	-	±100	nA	V _{GS} =±20V, V _{DS} =0V
I _{DSS}	-	-	-1	μA	V _{DS} =-48V, V _{GS} =0V
	-	-	-25		V _{DS} =-48V, V _{GS} =0V, T _J =125°C
R _{DS(ON)} *1	-	18.8	25	mΩ	V _{GS} =-10V, I _D =-20A
	-	21.8	30		V _{GS} =-4.5V, I _D =-20A
G _{FS} *1	-	38	-	S	V _{DS} =-5V, I _D =-20A
Dynamic					
Q _g *1, 2	-	62	-	nC	I _D =-20A, V _{DS} =-30V, V _{GS} =-10V
Q _{gs} *1, 2	-	8	-		
Q _{gd} *1, 2	-	12.4	-		
t _{d(ON)} *1, 2	-	12	-	ns	V _{DS} =-30V, I _D =-20A, V _{GS} =-10V, R _G =3Ω
t _r *1, 2	-	18	-		
t _{d(OFF)} *1, 2	-	91	-		
t _f *1, 2	-	20	-		
C _{iss}	-	4015	-	pF	V _{GS} =0V, V _{DS} =-30V, f=1MHz
C _{oss}	-	164	-		
C _{rss}	-	110	-		
Source-Drain Diode Ratings and Characteristics					
V _{SD} *1	-	-0.86	-1.2	V	I _S =-20A, V _{GS} =0V
t _{rr}	-	16	-	ns	I _F =-8.3A, dI _F /dt=100A/μs
Q _{rr}	-	9.4	-	nC	

Note : *1.Pulse Test : Pulse Width ≤300μs, Duty Cycle≤2%
 *2.Independent of operating temperature
 *3.Pulse width limited by maximum junction temperature.



Typical Characteristics

Typical Output Characteristics

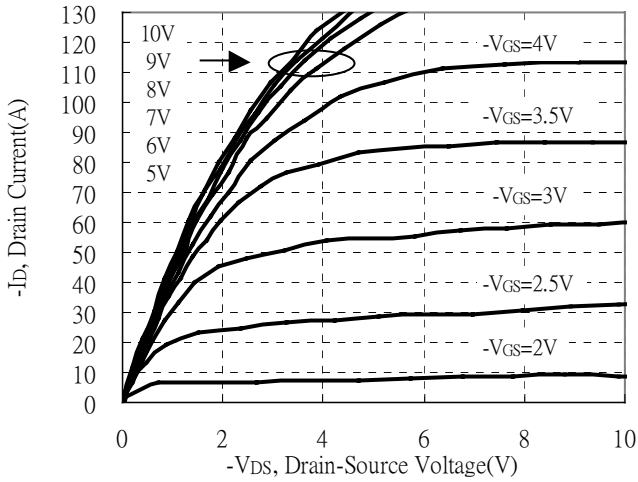

Brekdown Voltage vs Ambient Temperature

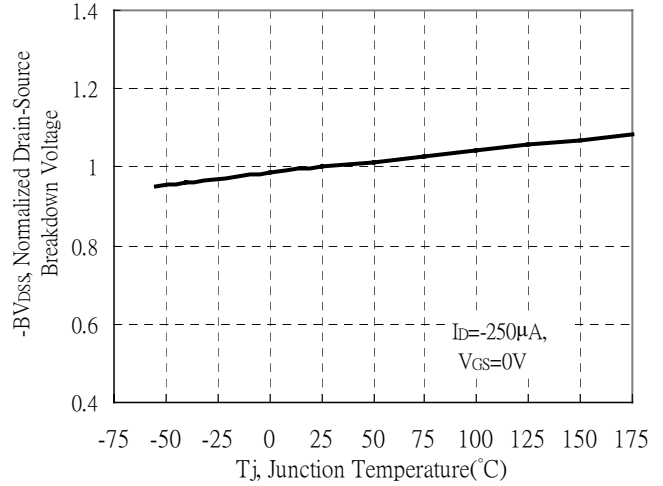

Static Drain-Source On-State resistance vs Drain Current

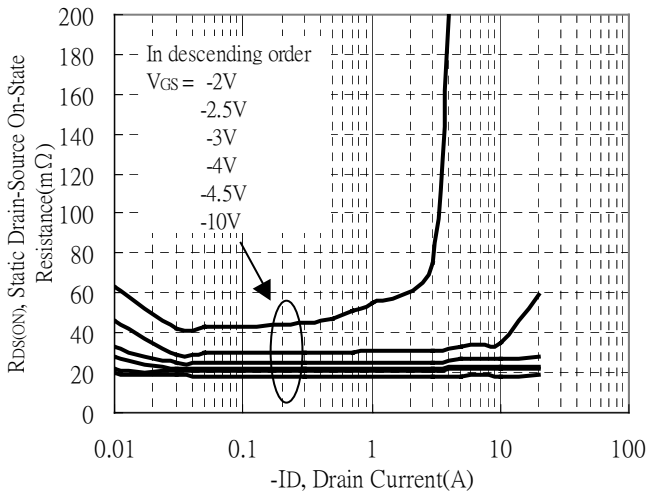

Reverse Drain Current vs Source-Drain Voltage

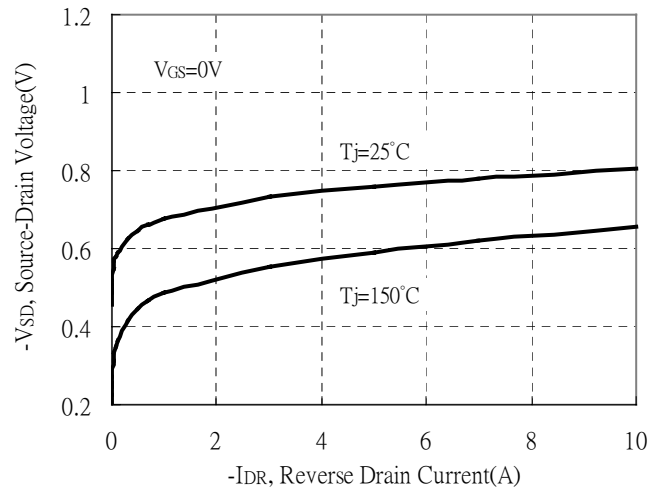

Static Drain-Source On-State Resistance vs Gate-Source Voltage

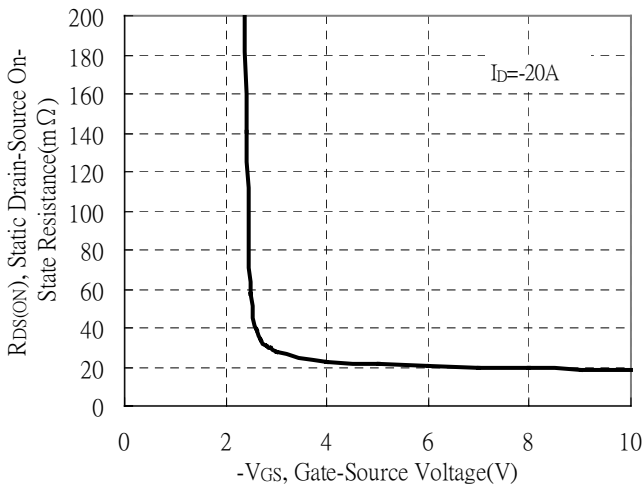

Drain-Source On-State Resistance vs Junction Temperature

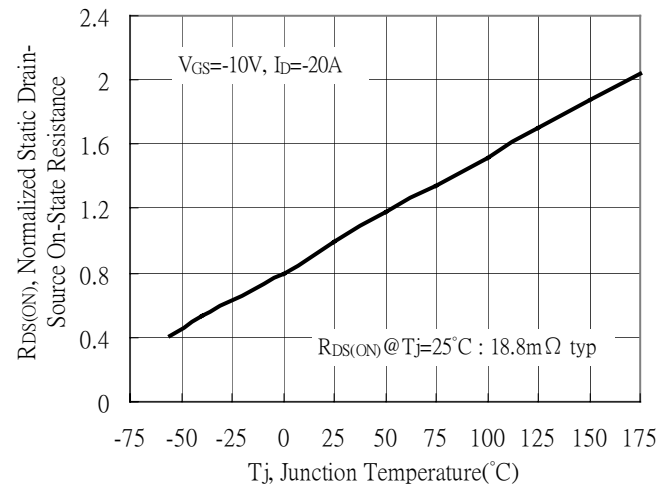



Typical Characteristics (Cont.)

Capacitance vs Drain-to-Source Voltage

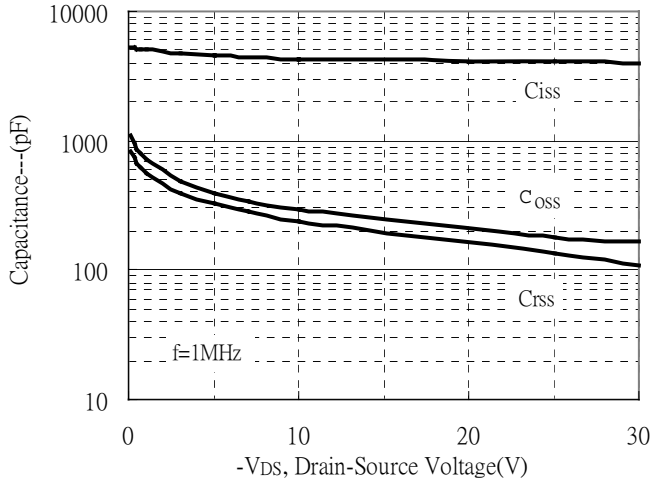

Threshold Voltage vs Junction Temperature

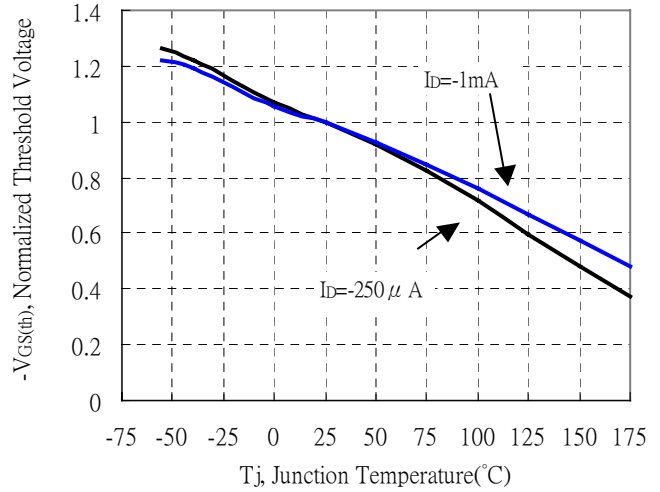

Maximum Safe Operating Area

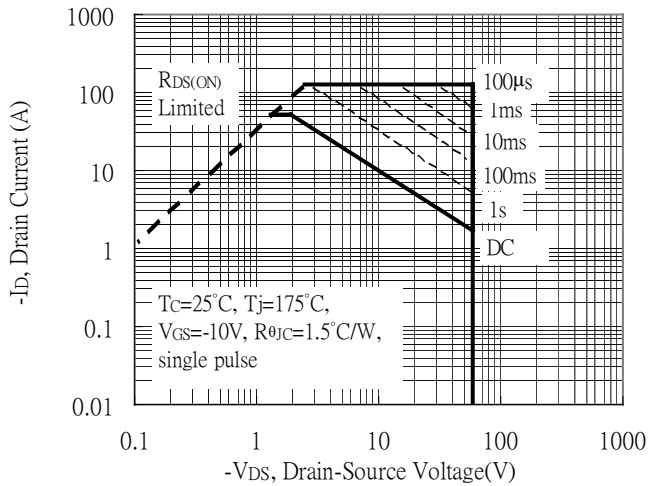

Gate Charge Characteristics

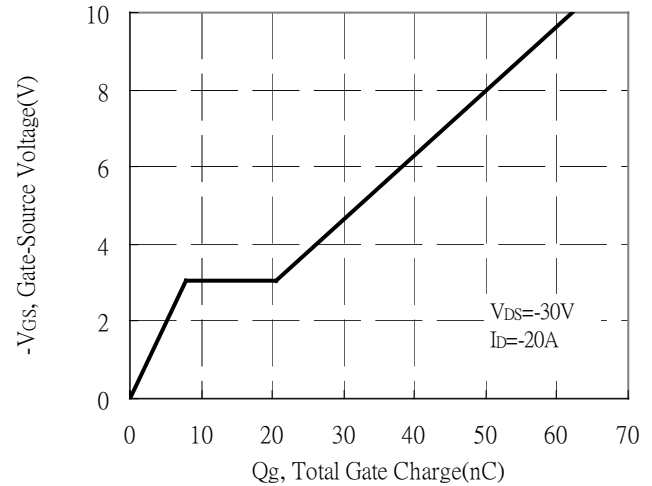

Forward Transfer Admittance vs Drain Current

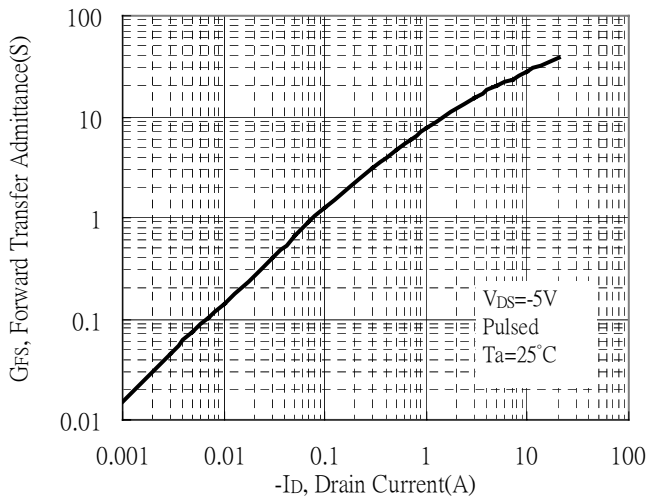

Maximum Drain Current vs Case Temperature

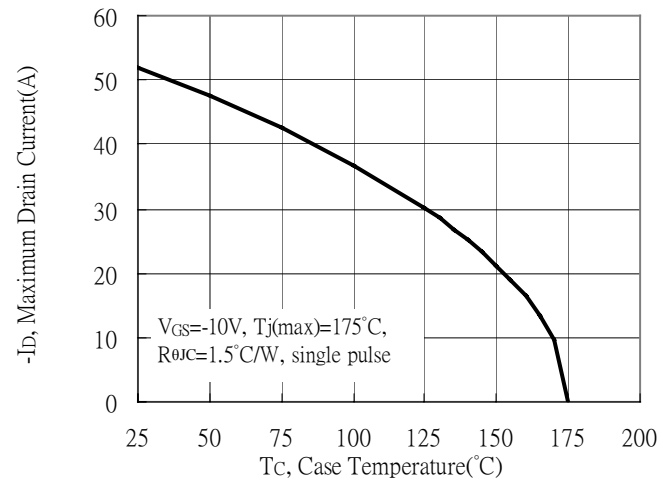



Typical Characteristics (Cont.)

Typical Transfer Characteristics

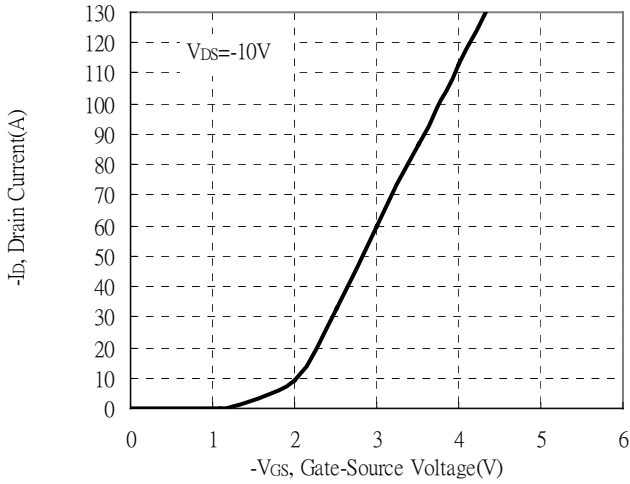

Power Derating Curve

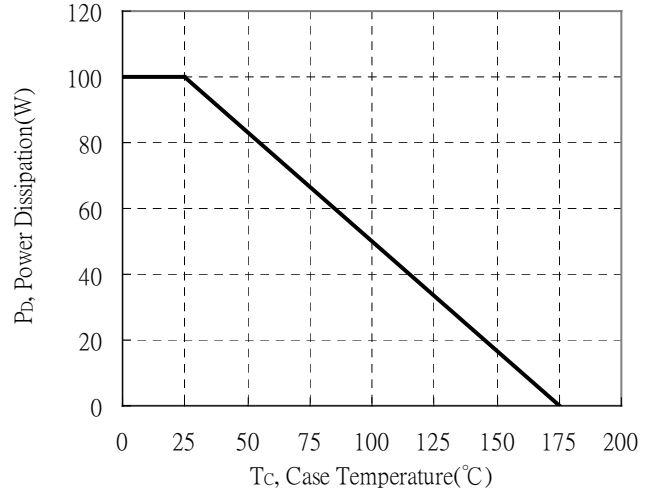

Transient Thermal Response Curves

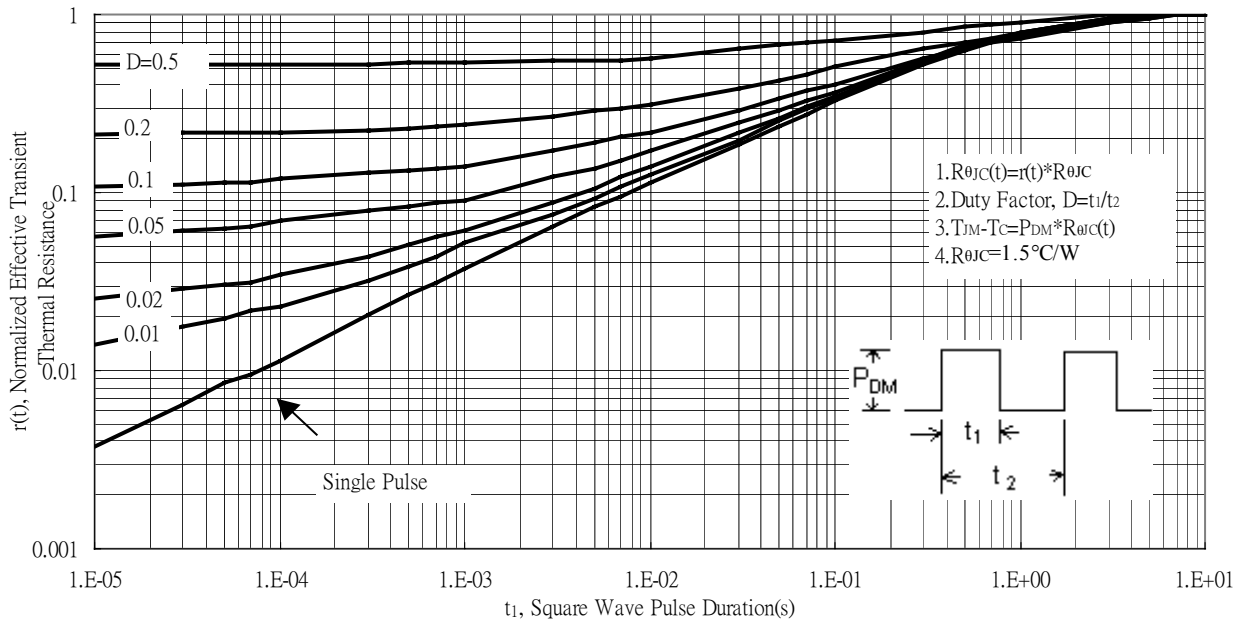

Recommended wave soldering condition

Product	Peak Temperature	Soldering Time
Pb-free devices	260 +0/-5 °C	5 +1/-1 seconds

Recommended temperature profile for IR reflow

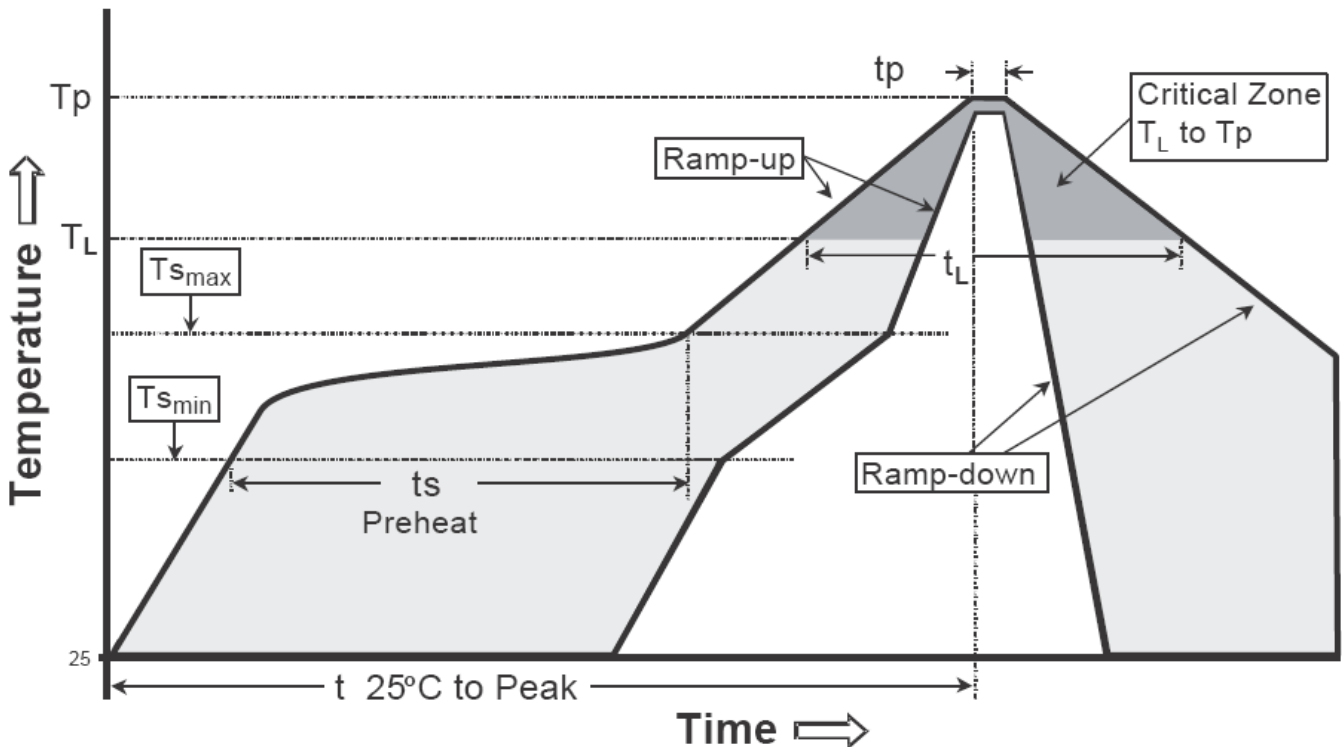

Profile feature	Sn-Pb eutectic Assembly	Pb-free Assembly
Average ramp-up rate (T _{smax} to T _p)	3°C/second max.	3°C/second max.
Preheat		
-Temperature Min(T _{s min})	100°C	150°C
-Temperature Max(T _{s max})	150°C	200°C
-Time(t _{s min} to t _{s max})	60-120 seconds	60-180 seconds
Time maintained above:		
-Temperature (T _L)	183°C	217°C
- Time (t _L)	60-150 seconds	60-150 seconds
Peak Temperature(T _P)	240 +0/-5 °C	260 +0/-5 °C
Time within 5°C of actual peak temperature(tp)	10-30 seconds	20-40 seconds
Ramp down rate	6°C/second max.	6°C/second max.
Time 25 °C to peak temperature	6 minutes max.	8 minutes max.

Note : All temperatures refer to topside of the package, measured on the package body surface.

TO-220FP Dimension

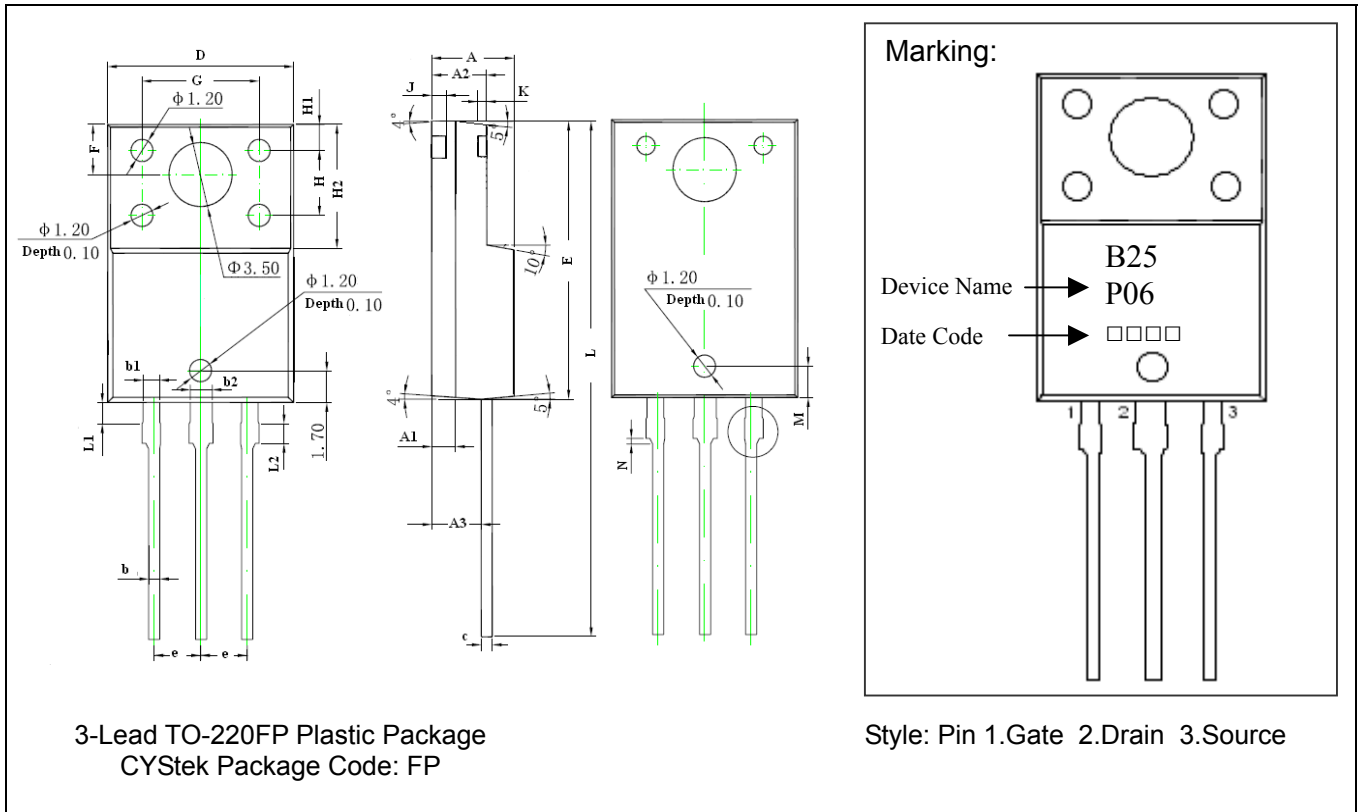

*Typical

DIM	Inches		Millimeters		DIM	Inches		Millimeters	
	Min.	Max.	Min.	Max.		Min.	Max.	Min.	Max.
A	0.171	0.183	4.35	4.65	G	0.246	0.258	6.25	6.55
A1	0.051 REF		1.300 REF		H	0.138 REF		3.50 REF	
A2	0.112	0.124	2.85	3.15	H1	0.055 REF		1.40 REF	
A3	0.102	0.110	2.60	2.80	H2	0.256	0.272	6.50	6.90
b	0.020	0.030	0.50	0.75	J	0.031 REF		0.80 REF	
b1	0.031	0.041	0.80	1.05	K	0.020		0.50 REF	
b2	0.047 REF		1.20 REF		L	1.102	1.118	28.00	28.40
c	0.020	0.030	0.500	0.750	L1	0.043	0.051	1.10	1.30
D	0.396	0.404	10.06	10.26	L2	0.036	0.043	0.92	1.08
E	0.583	0.598	14.80	15.20	M	0.067 REF		1.70 REF	
e	0.100 *		2.54*		N	0.012 REF		0.30 REF	
F	0.106 REF		2.70 REF						

- Notes:**
- Controlling dimension: millimeters.
 - Maximum lead thickness includes lead finish thickness, and minimum lead thickness is the minimum thickness of base material.
 - If there is any question with packing specification or packing method, please contact your local CYStek sales office.

Material:

- Lead: Pure tin plated.
- Mold Compound: Epoxy resin family, flammability solid burning class: UL94V-0.

Important Notice:

- All rights are reserved. Reproduction in whole or in part is prohibited without the prior written approval of CYStek.
- CYStek reserves the right to make changes to its products without notice.
- CYStek **semiconductor products are not warranted to be suitable for use in Life-Support Applications, or systems.**
- CYStek assumes no liability for any consequence of customer product design, infringement of patents, or application assistance.