

1 Device Overview

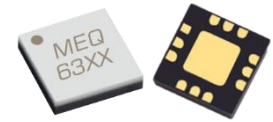

QFN

1.1 General Description

The MEQX-20ASM family of passive MMIC equalizer QFN are an ideal solution for compensating for low pass filtering effects in RF/microwave and high speed digital systems. They provide positive slope from DC to 20GHz with DC attenuation options between 3 and 11dB. The unique design offers superior return loss to competitors. GaAs MMIC technology provides consistent unit-to-unit performance in a small, low cost form factor.

1.2 Features

- DC attenuation options from 3 to 11dB
- Typical Insertion Loss 1.2 dB at 20GHz
- VSWR < 1.5:1 Over Entire Band
- S2P data: [MEQX-XASM.zip](#)

1.3 Applications

- RF Transceivers
- High-Speed Data
- Telecom
- Cable Loss Compensation
- Amplifier Compensation

1.4 Functional Block Diagram



1.5 Part Ordering Options¹

Part Number	Loss at DC (dB)	Description	Package	Green Status	Product Lifecycle	Export Classification
MEQ3-20ASM	3	3x3 mm QFN	SM	RoHS	Active	EAR99
MEQ5-20ASM	5					
MEQ6-20ASM	6					
MEQ7-20ASM	7.4					
MEQ10-20ASM	10					
MEQ11-20ASM	11					
EVAL-MEQ3-20A	3	Connectorized Eval Module	Module			
EVAL-MEQ5-20A	5					
EVAL-MEQ6-20A	6					
EVAL-MEQ7-20A	7.4					
EVAL-MEQ10-20A	10					
EVAL-MEQ11-20A	11					

¹ Refer to our [website](#) for a list of definitions for terminology presented in this table.

Table of Contents

1	Device Overview	1	3	Specifications	4
1.1	General Description	1	3.1	Absolute Maximum Ratings	4
1.2	Features	1	3.2	Package Information.....	4
1.3	Applications	1	3.3	Electrical Specifications	4
1.4	Functional Block Diagram	1	3.4	Typical Performance Plots	5
1.5	Part Ordering Options.....	1	3.4.1	Insertion Loss	5
2	Port Configurations and Functions	3	3.4.2	Return Loss & Group Delay ..	6
2.1	Port Diagram.....	3	4	Mechanical Data.....	8
2.2	Port Functions	3	4.1	SM Package Outline Drawing	8
			4.2	Eval Package Outline Drawing	8

Revision History

Revision Code	Revision Date	Comment
-	June 27, 2018	Datasheet Initial Release
A	August 2018	Added §4.2, EVAL Outline
B	November 2018	Updated §4.2, EVAL Outline
C	March 2019	Added ESD Rating
D	May 2019	Corrected Table in 4.1, Added Package Dimension Tolerance Spec
E	August 2019	Added §4.2, SM Footprint

2 Port Configurations and Functions

2.1 Port Diagram

A top-down view of the MEQX-20ASM package outline drawing is shown below. The MEQ equalizers are symmetrical allowing Port 1 or Port 2 to be used as the input.

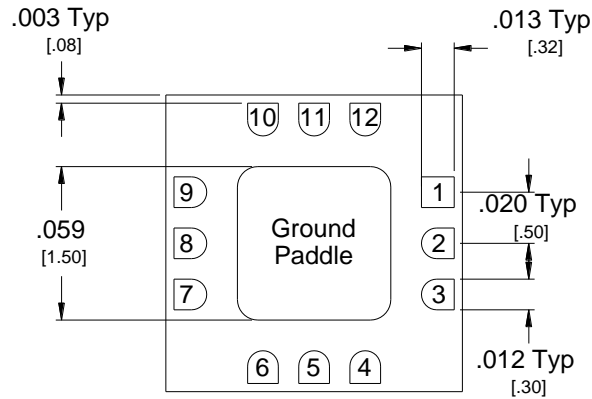

2.2 Port Functions

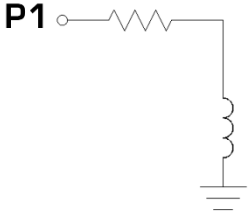
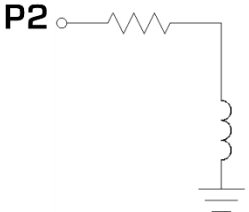
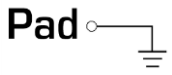
Port	Function	Description	Equivalent Circuit
Pin 1	Input/Output	Port 1 is DC connected to ground through a resistor. DC block is required if voltage present.	
Pin 9	Input/Output	Port 2 is DC connected to ground through a resistor. DC block is required if voltage present.	
GND	Ground	SM package ground path is provided through the ground paddle.	

3 Specifications

3.1 Absolute Maximum Ratings

The Absolute Maximum Ratings indicate limits beyond which damage may occur to the device. If these limits are exceeded, the device may be inoperable or have a reduced lifetime.

Parameter	Maximum Rating	Units
Port 1 DC Current	40	mA
Port 2 DC Current	40	mA
Power Handling, at any Port	+30	dBm
Operating Temperature	-55 to +100	°C
Storage Temperature	-65 to +125	°C

3.2 Package Information

Parameter	Details	Rating
ESD	Human Body Model (HBM), per MIL-STD-750, Method 1020	1A

3.3 Electrical Specifications²

The electrical specifications apply at $T_A=+25^\circ\text{C}$ in a 50Ω system. Typical data shown is for the equalizer in a SM package with a sine wave input applied to port 1.

Min and Max limits are guaranteed at $T_A=+25^\circ\text{C}$. All bare die are 100% DC tested and visually inspected.

Part Number	Typical Insertion Loss		Typical Return Loss	Units
	DC	20 GHz	DC-14 GHz	
MEQ3-20ASM	3	1	19	dB
MEQ5-20ASM	5	1.1	22	dB
MEQ6-20ASM	6	1	23	dB
MEQ7-20ASM	7.5	1.1	26	dB
MEQ10-20ASM	10	0.9	20	dB
MEQ11-20ASM	11	1.2	27	dB

² Equalizer is symmetrical. Reverse measurement is equivalent to forward measurement. All measurements taken in eval board without de-embedding.

3.4 Typical Performance Plots

3.4.1 Insertion Loss

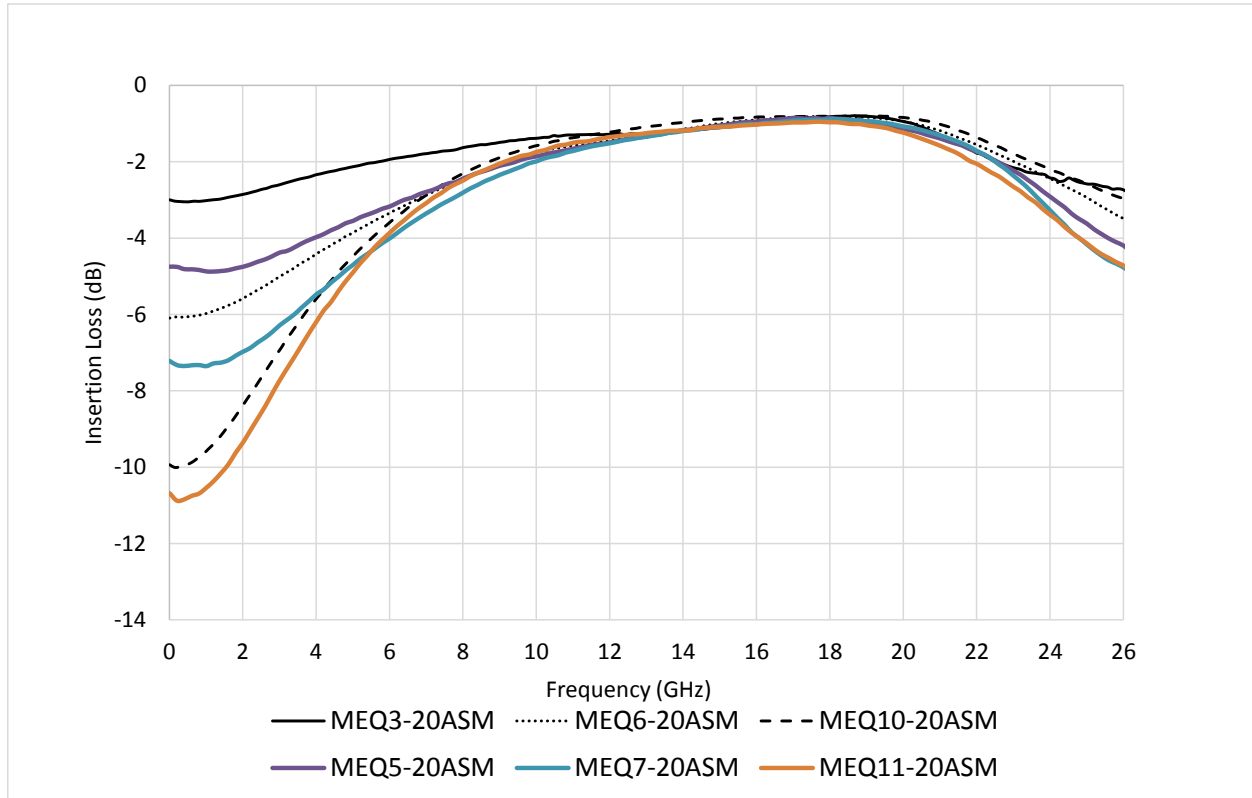

3.4.2 Return Loss & Group Delay³

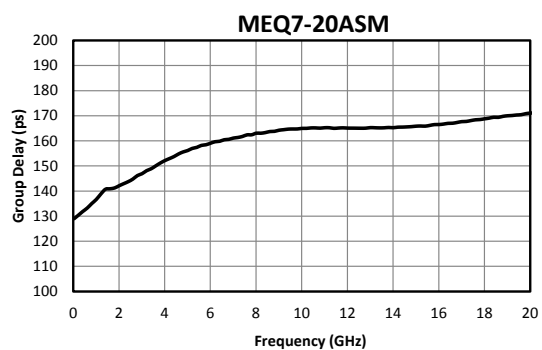
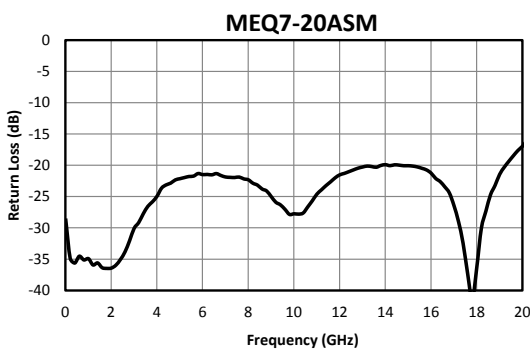
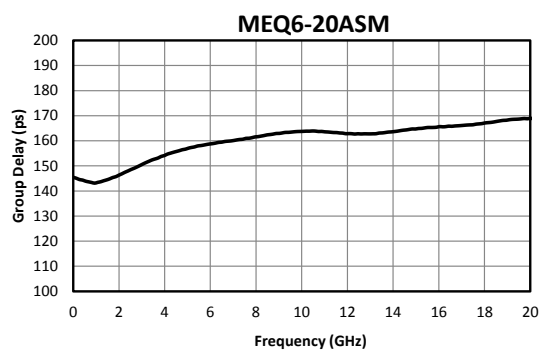
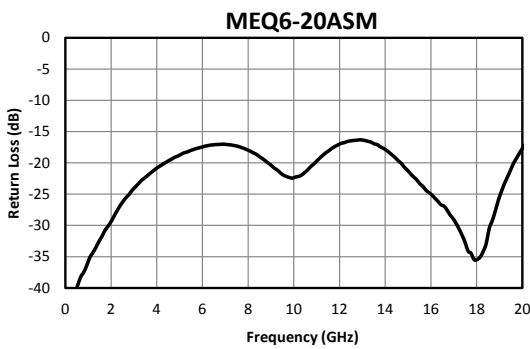
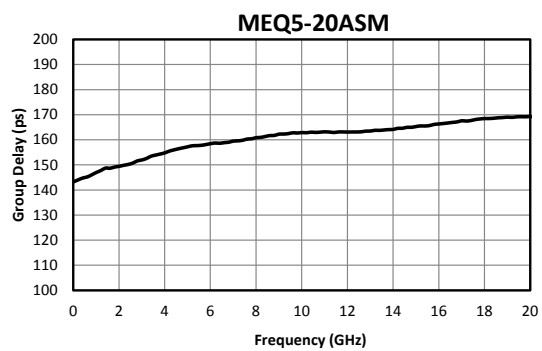
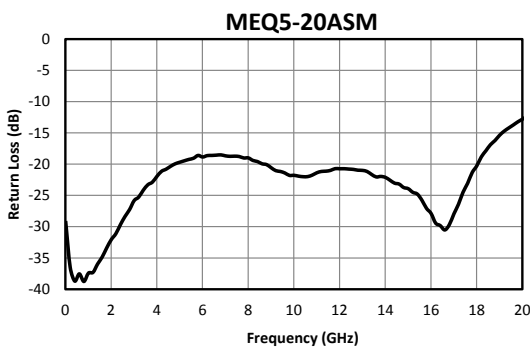
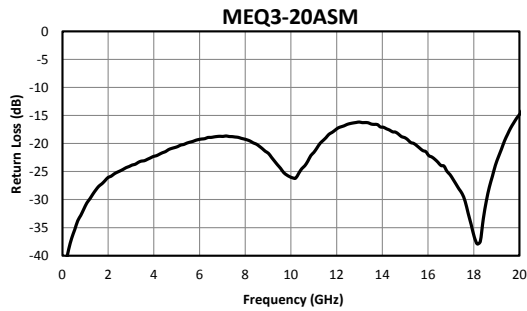

³ Group delay measured in eval board without de-embedding.

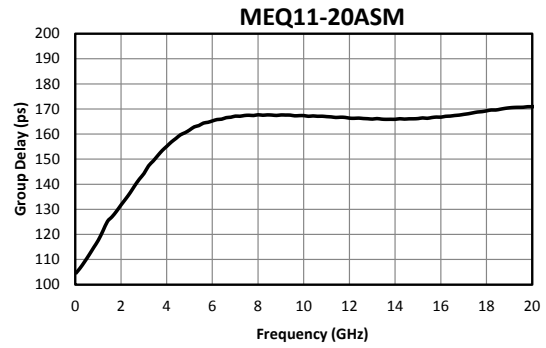
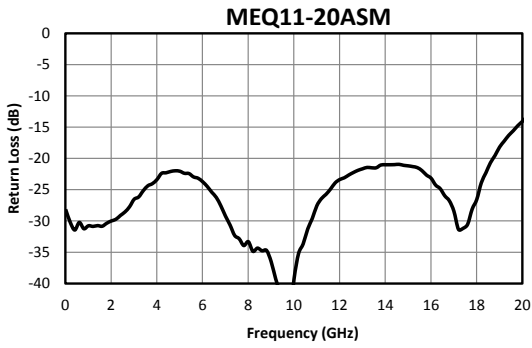
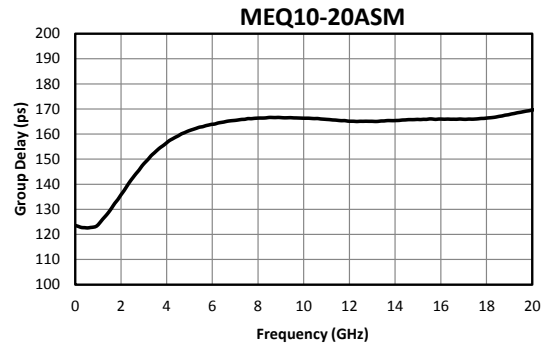
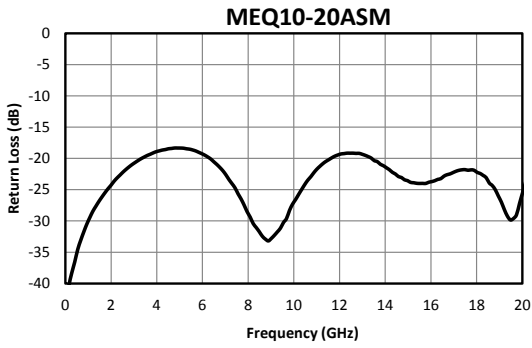

4 Mechanical Data

4.1 SM Package Outline Drawing

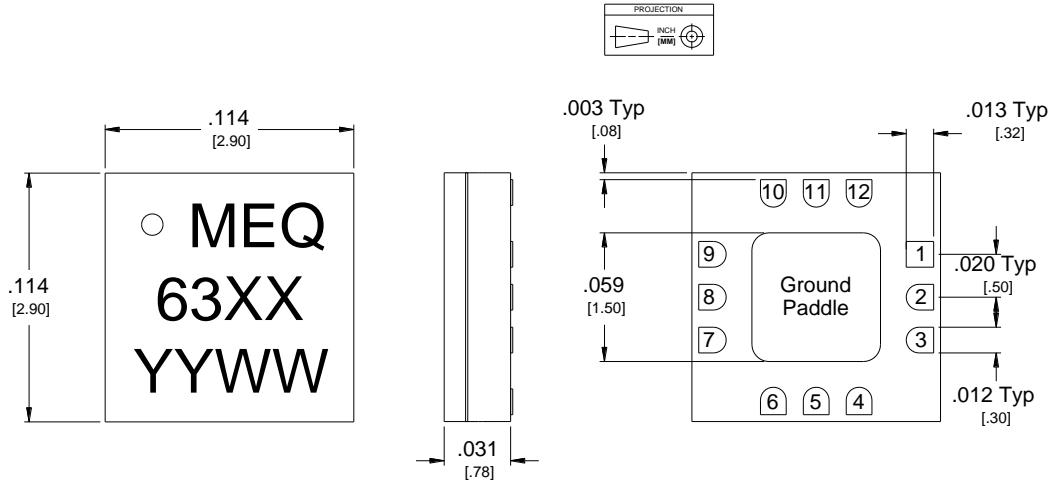

Unless otherwise specified, dimensions are in inches. Tolerances are:

.XX ±.02
.XXX ±.005

- Substrate material is ceramic.
- I/O Leads and Ground Paddle plating is (from base to finish):
Ni: 8.89um MAX 1.27um MIN
Pd: 0.17um MAX 0.07um MIN
Au 0.254um MAX 0.03um MIN
- All unconnected pads should be connected to PCB RF ground.

Part Number	Circuit Number
MEQ3-20ASM	6339
MEQ6-20ASM	6340
MEQ10-20ASM	6341
MEQ5-20ASM	6342
MEQ7-20ASM	6343
MEQ11-20ASM	6345

4.2 SM Package Footprint

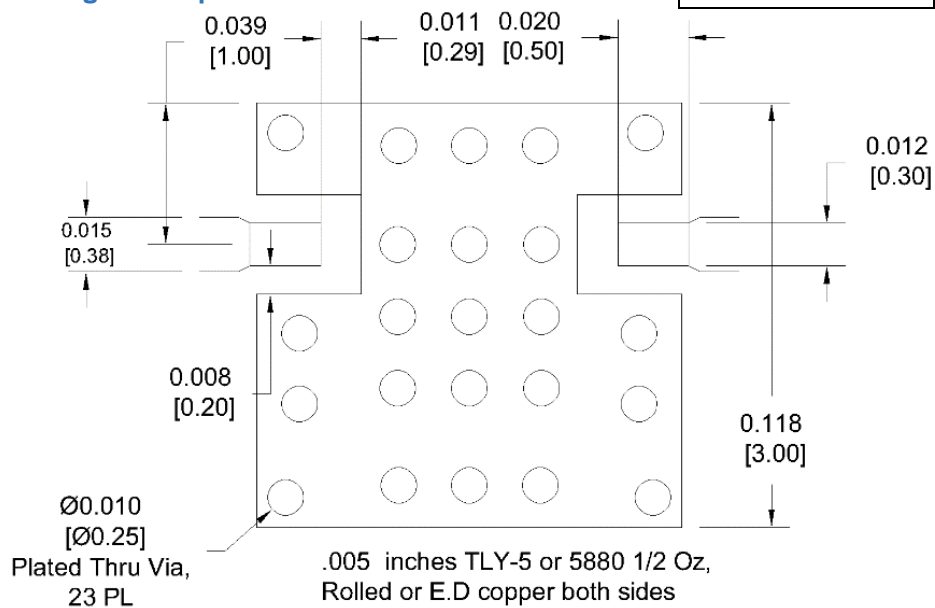

SM-Package Surface-Mount Landing Pattern

[Click here for a DXF of the above layout.](#)

[Click here for leaded solder reflow.](#) [Click here for lead-free solder reflow](#)

4.3 Eval Package Outline Drawing

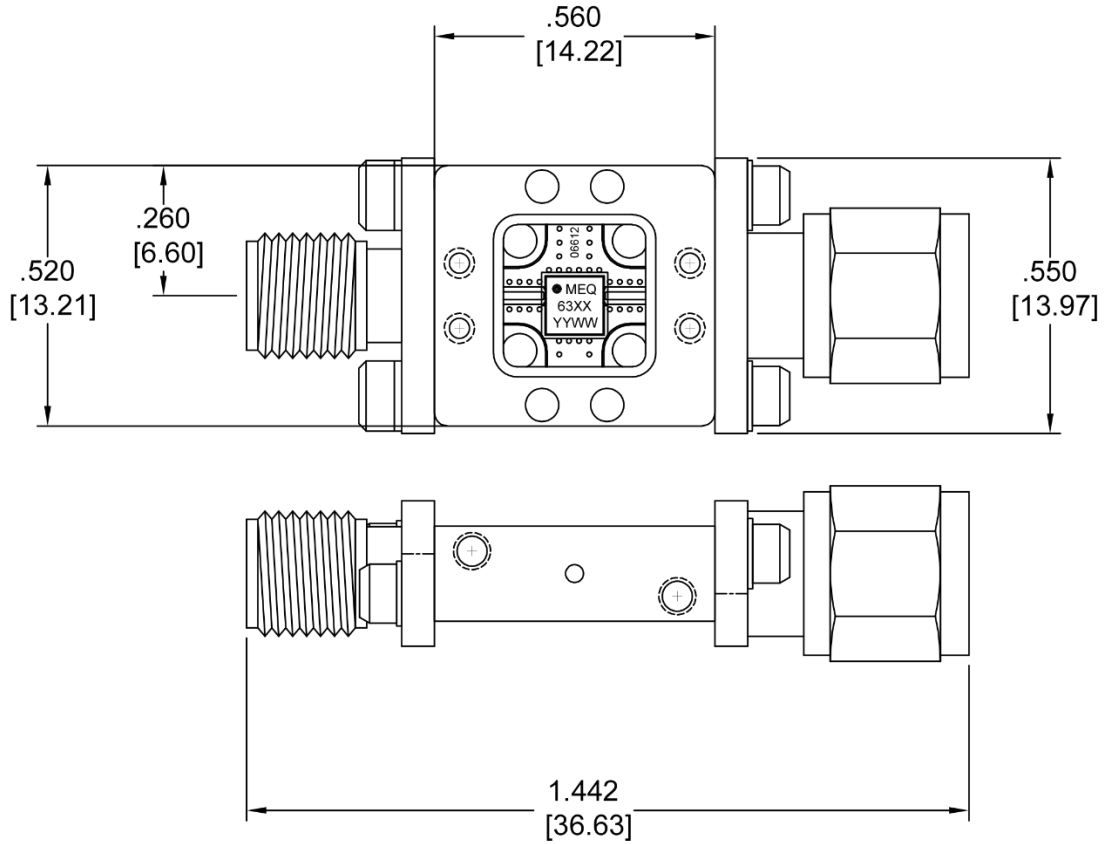

XX	Part Number
39	Eval-MEQ3-20A
40	Eval-MEQ6-20A
41	Eval-MEQ10-20A
42	Eval-MEQ5-20A
43	Eval-MEQ7-20A
45	Eval-MEQ11-20A

Port	Connector Type
I	SMA Female
O	SMA Male

Note: Eval-Package Connectors are not removeable.

Unless otherwise specified, dimensions are in inches. Tolerances are:

.XX ±.02
.XXX ±.005

Marki Microwave reserves the right to make changes to the product(s) or information contained herein without notice.
Marki Microwave makes no warranty, representation, or guarantee regarding the suitability of its products for any particular purpose, nor does Marki Microwave assume any liability whatsoever arising out of the use or application of any product.