

DATA SHEET

SKY65135: WLAN Power Amplifier

Applications

- IEEE802.11 b/g WLAN
- ISM band
- WCS fixed wireless
- Wireless access nodes

Features

- Linear output power of +31 dBm for IEEE802.11b mask
- Linear output power of +30 dBm for IEEE802.11g mask
- Three percent EVM at $P_{OUT} > +27$ dBm
- High gain of 33 dB
- Output power detector: 20 dB dynamic range
- Superior gain flatness
- Internal RF match and bias circuits
- Small footprint, MCM (20-pin, 6 x 6 mm) Pb-free (MSL3, 250 °C per JEDEC J-STD-020) SMT package

NEW Skyworks offers lead (Pb)-free RoHS (Restriction of Hazardous Substances) compliant packaging.



Description

Skyworks SKY65135 is a Microwave Monolithic Integrated Circuit (MMIC) Power Amplifier (PA) with superior output power, linearity, and efficiency. These features make the SKY65135 ideal for Wireless Local Area Network (WLAN) applications.

The device is fabricated using Skyworks high reliability Indium Gallium Phosphide (InGaP) Heterojunction Bipolar Transistor (HBT) technology. The device is internally matched and mounted in a 20-pin, 6 x 6 mm Multi-Chip Module (MCM) Surface-Mounted Technology (SMT) package, which allows for a highly manufacturable low cost solution.

The device package and pinout for the 20-pin MCM are shown in Figure 1. A block diagram of the SKY65135 is shown in Figure 2.

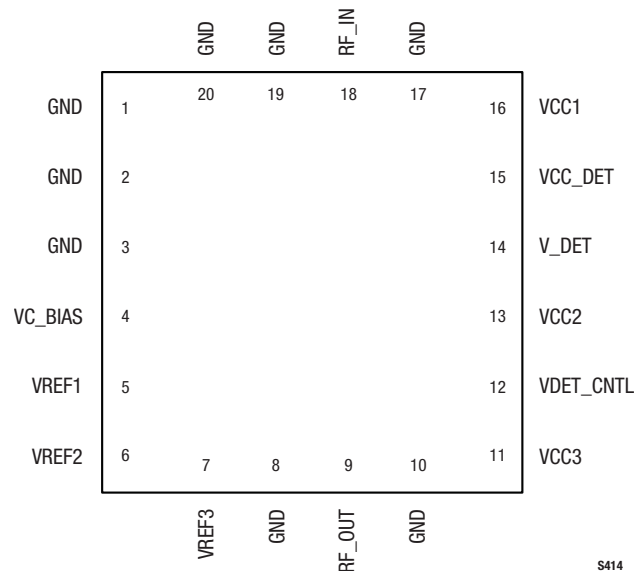

Figure 1. SKY65135 Pinout – 20-Pin MCM (Top View)

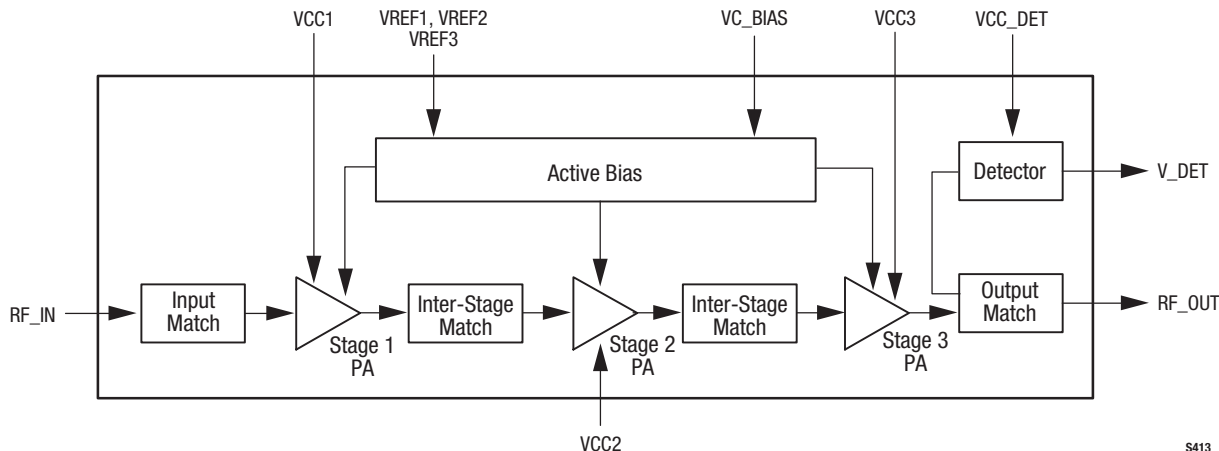

Figure 2. SKY65135 Block Diagram

Technical Description

The SKY65135 PA contains all of the needed RF matching and DC biasing circuits. The device also provides an output power detector voltage.

The SKY65135 is a three-stage, HBT InGaP device optimized for high linearity and power efficiency. These features make the device suitable for wideband digital applications, where PA linearity and power consumption are of critical importance (e.g., WLANs).

The device has been characterized with the highest specified data rates for 802.11b (11 Mbps) and 802.11g (54 Mbps). Under these stringent test conditions, the device exhibits excellent spectral purity and power efficiency.

Package and Handling Information

Since the device package is sensitive to moisture absorption, it is baked and vacuum packed before shipping. Instructions on the shipping container label regarding exposure to moisture after the container seal is broken must be followed. Otherwise, problems related to moisture absorption may occur when the part is subjected to high temperature during solder assembly.

The SKY65135 is rated to Moisture Sensitivity Level 3 (MSL3) at 250 °C. It can be used for lead or lead-free soldering. For additional information, refer to Skyworks Application Note, *PCB Design and SMT Assembly/Rework Guidelines for MCM-L Packages*, document number 101752.

Care must be taken when attaching this product, whether it is done manually or in a production solder reflow environment. Production quantities of this product are shipped in a standard tape and reel format. For packaging details, refer to the Skyworks Application Note, *Tape and Reel*, document number 101568.

Electrical and Mechanical Specifications

Signal pin assignments and functional pin descriptions are described in Table 1. The absolute maximum ratings of the SKY65135 are provided in Table 2. Electrical specifications are provided in Table 3.

Typical performance characteristics are shown in Figures 3 through 11. Figure 12 provides a typical evaluation board schematic. An assembly drawing for the Evaluation Board is shown in Figure 13 and the layer detail is provided in Figure 14. The layer detail physical characteristics are noted in Figure 15. The phone board layout footprint for the SKY65135 is shown in Figure 16. Package dimensions for the 20-pin MCM are shown in Figure 17, and tape and reel dimensions are provided in Figure 18.

Electrostatic Discharge (ESD) Sensitivity

The SKY65135 is a static-sensitive electronic device. Do not operate or store near strong electrostatic fields. Take proper ESD precautions.

Table 1. SKY65135 Signal Descriptions

Pin #	Name	Description	Pin #	Name	Description
1	GND	Ground	11	VCC3	Stage 3 collector voltage
2	GND	Ground	12	VDET_CNTL	Detector voltage control
3	GND	Ground	13	VCC2	Stage 2 collector voltage
4	VC_BIAS	Bias voltage	14	V_DET	Detector output signal
5	VREF1	Bias reference voltage 1	15	VCC_DET	Detector supply voltage
6	VREF2	Bias reference voltage 2	16	VCC1	Stage 1 collector voltage
7	VREF3	Bias reference voltage 3	17	GND	Ground
8	GND	Ground	18	RF_IN	RF input
9	RF_OUT	RF output	19	GND	Ground
10	GND	Ground	20	GND	Ground

Table 2. SKY65135 Absolute Maximum Ratings (Note 1)

Parameter	Symbol	Minimum	Maximum	Units
RF output power	P _{OUT}		30	dBm
Supply voltage, measured at pin of package (Note 2)	VREF1, VREF2, VREF3, VCC1, VCC2, and VCC_DET		4	V
3 rd stage supply voltage	VCC3, VC_BIAS		6	V
Total supply current (I _{CC} + I _{BIAS} + I _{REF})	I _{CC_TOTAL}		1200	mA
Power dissipation			4.0	W
Case operating temperature	T _C	-40	+85	°C
Storage temperature	T _{ST}	-55	+125	°C
Junction temperature	T _J		+150	°C

Note 1: Exposure to maximum rating conditions for extended periods may reduce device reliability. There is no damage to device with only one parameter set at the limit and all other parameters set at or below their nominal value.

Note 2: Evaluation Board supply voltage levels can be different. Refer to the Evaluation Board schematic diagram in Figure 12.

Table 3. SKY65135 Recommended Operating Conditions

Parameter	Symbol	Minimum	Typical	Maximum	Units
RF input power	P _{IN}			-6	dBm
Supply voltage, measured at pin of package (Note 1)	VREF1, VREF2, and VREF3	2.3	2.5	2.7	V
	VCC1 and VCC2	3.0	3.3	3.6	V
	VCC_DET	3.3	3.6	3.9	V
	VCC3 and VC_BIAS	4.5	5.0	5.5	V
Case operating temperature	T _C	-40		+85	°C
Storage temperature	T _{ST}	-55		+125	°C

Note 1: Evaluation Board supply voltage levels can be different. Refer to the Evaluation Board schematic diagram in Figure 12.

Table 4. SKY65135 Electrical Specifications
(VCC1 = VCC2 = 3.3 V, VCC3 = 5 V, Tc = +25 °C, Test Frequency = 2.442 GHz unless otherwise noted)

Parameter	Symbol	Test Condition	Min	Typical	Max	Units
Using IEEE802.11b Complimentary Code Keying Input Signal, Data Rate = 11 Mbps						
Total supply current	I _{CC_TOTAL}			1150		mA
Output power (Note 1)	P _{OUT}			31		dBm
Power added efficiency (Note 2)	PAE			25		%
Ramp-up/ramp-down (Note 3)	T _s			<0.5		μs
Using IEEE802.11g Orthogonal Frequency Division Multiplexing Input Signal, Data Rate = 54 Mbps						
Total supply current	I _{CC_TOTAL}			1050		mA
Output power (Note 4)	P _{OUT}			30		dBm
Output power @ EVM = 3%	P _{OUT_EVM}			27		dBm
Power added efficiency (Note 2)	PAE			22		%
Using Continuous Wave Input Signals						
Small signal gain	G	P _{IN} = -25 dBm	31.5	33	34.5	dB
Gain flatness over band		From 2.4 GHz to 2.5 GHz		±0.5		dB
Gain flatness over channel (16.25 MHz)		Over any 16.25 MHz within band		±0.1		dB
Output power @ 1 dB compression	P1dB	P _{IN} = 0 dBm	32	33		dBm
Output IP3	OIP3	P _{TONE} = +27 dBm, Delta_freq = 5 MHz		42		dBm
Quiescent Current	I _Q	No RF input		400	450	mA
Noise Figure	NF			5	6	dB
Power added efficiency @ P1dB	PAE		25	34		%

Note 1: Defined as the maximum power level for which the IEEE802.11b transmit mask requirements are met.

Note 2: Measured at the specified average output RF power and modulation type.

Note 3: Ramp-up and ramp-down times are defined from the 10% to 90% power points.

Note 4: Defined as the maximum power level for which the IEEE802.11g transmit mask requirements are met.

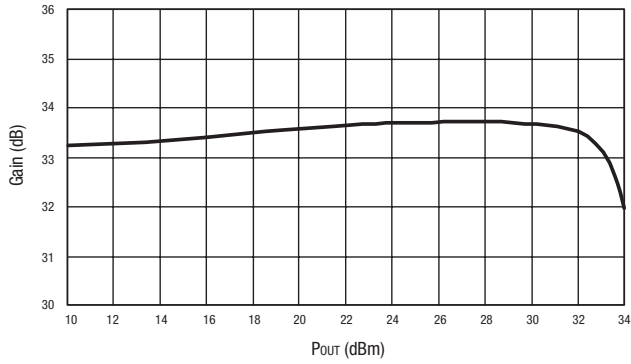

Figure 3. Typical Gain vs P_{OUT} @ 2.442 GHz

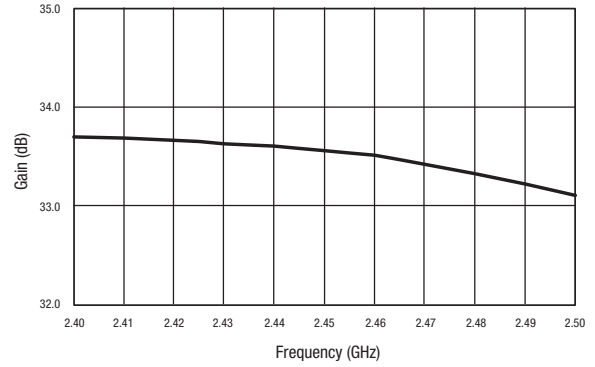

Figure 4. Typical Gain vs Frequency Response

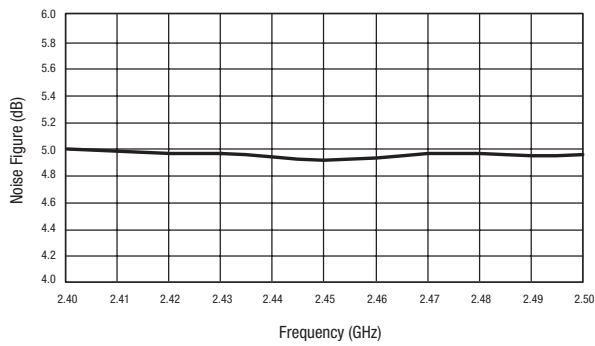

Figure 5. Typical Noise Figure Performance vs Frequency

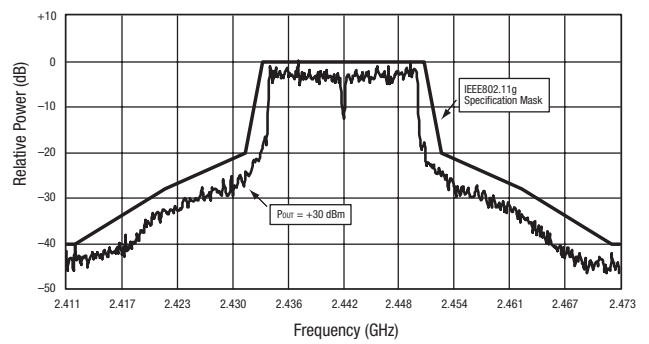

Figure 6. Output Spectrum Response for 802.11g @ 2.442 GHz and P_{OUT} = 30 dBm

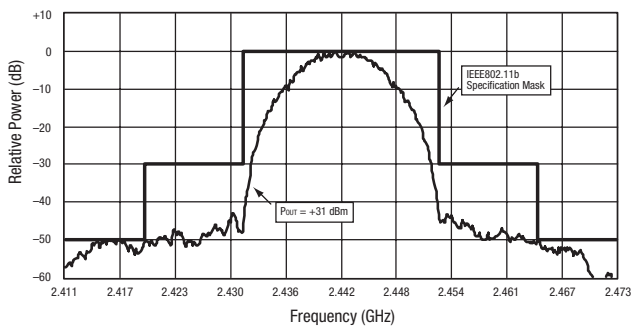

Figure 7. Output Spectrum Response for 802.11b CCK-Coded @ 2.442 GHz and P_{OUT} = 31 dBm

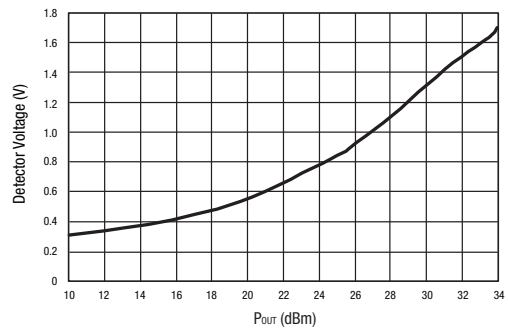

Figure 8. Detector Output Voltage vs RF Output Power @ 2.442 GHz

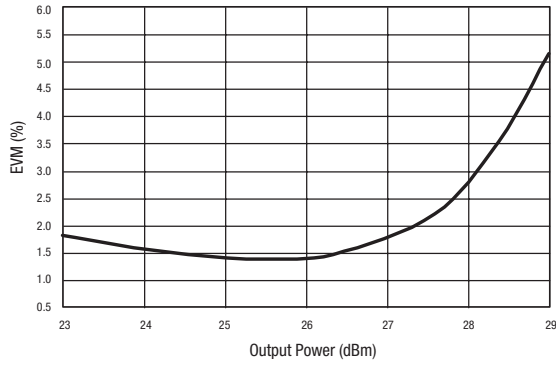

Figure 9. EVM vs P_{out} for 802.11g

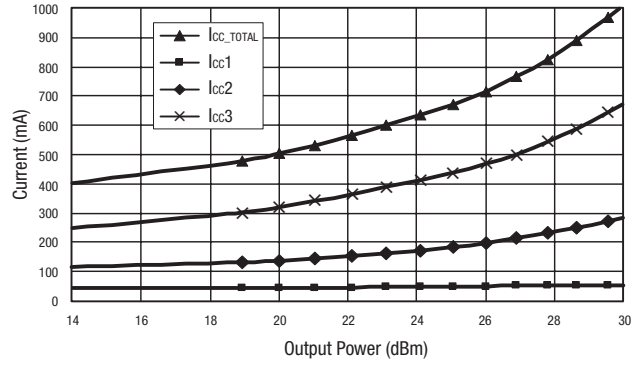

Figure 10. Individual Stage Currents and Total Current vs RF Output Power

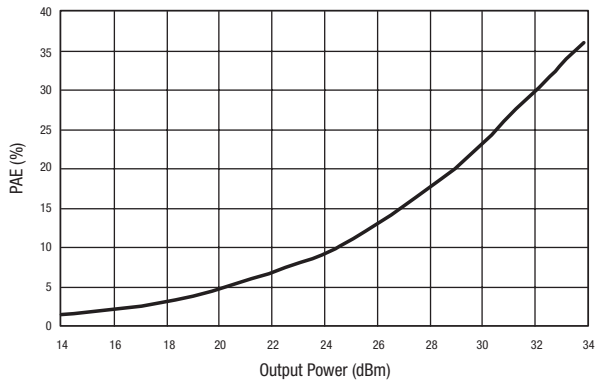
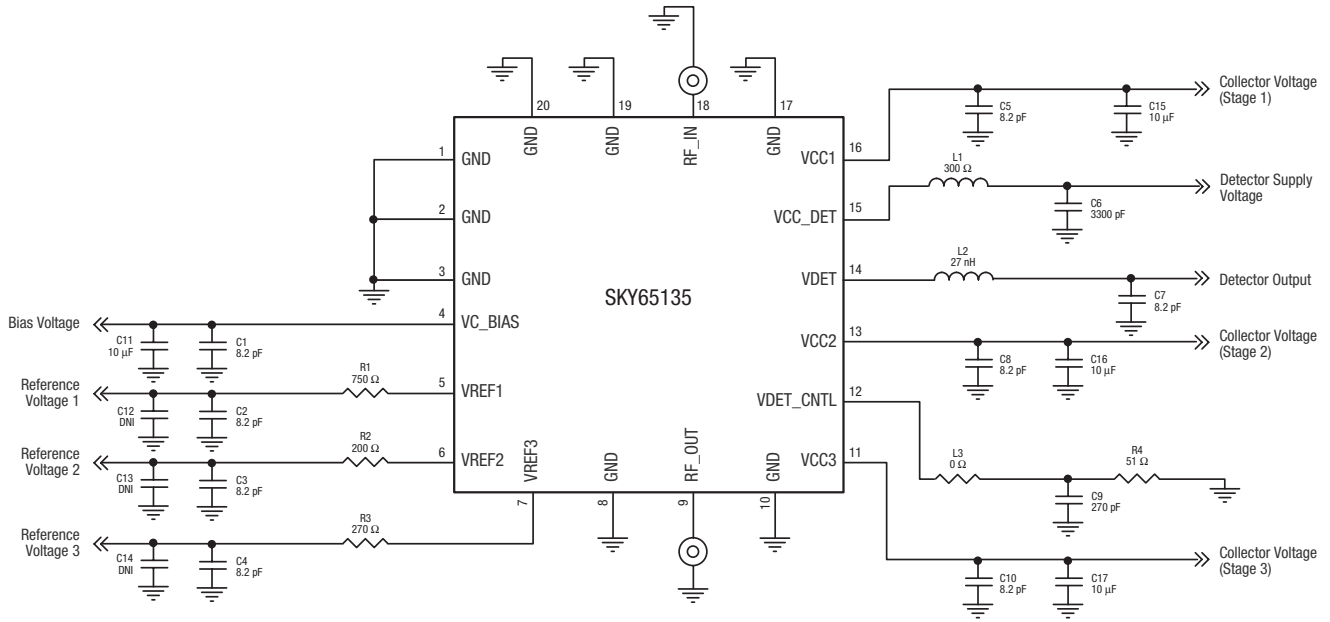

Figure 11. PAE vs Output Power



Note: Evaluation Board material: four-layer Rogers 4003-12, $\epsilon_r = 3.38$.

Some component labels may be different than the corresponding component symbol shown here. Component values, however, are accurate as of the date of this Data Sheet.

S702

Figure 12. SKY65135 Evaluation Board Schematic

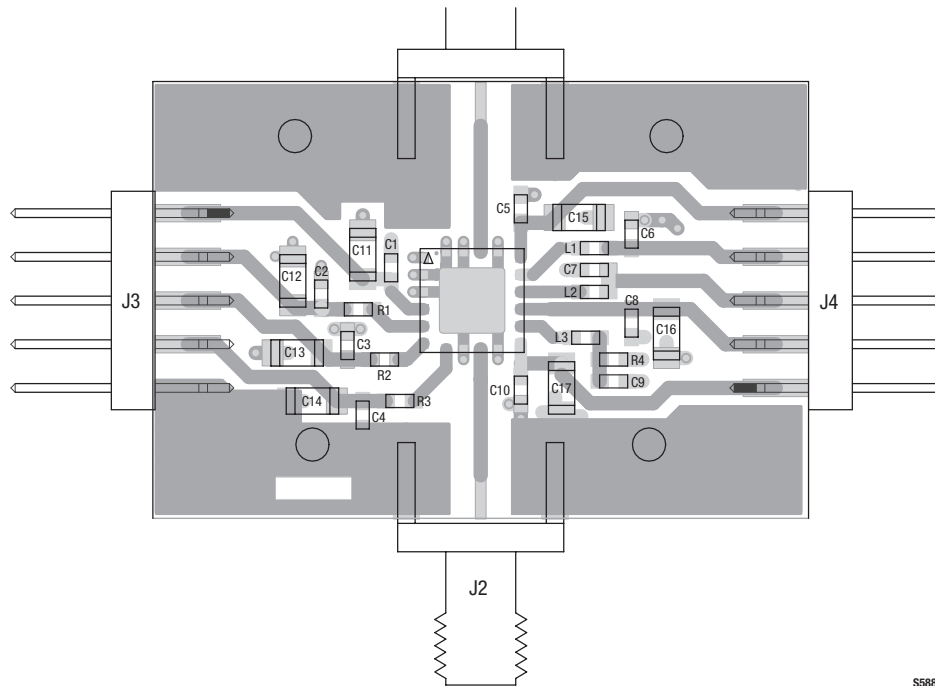

S588

Figure 13. Evaluation Board Assembly Drawing

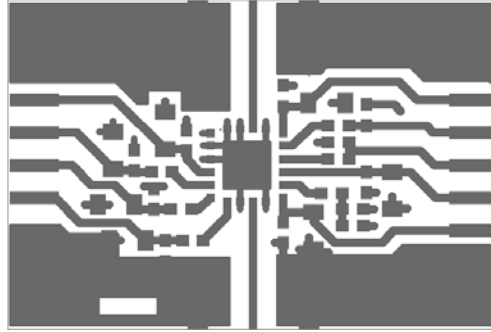

Layer 1: Top Metal

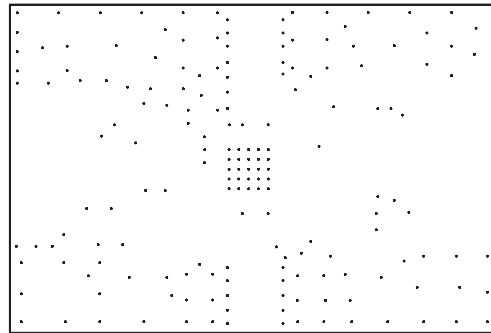

Layer 2: Ground

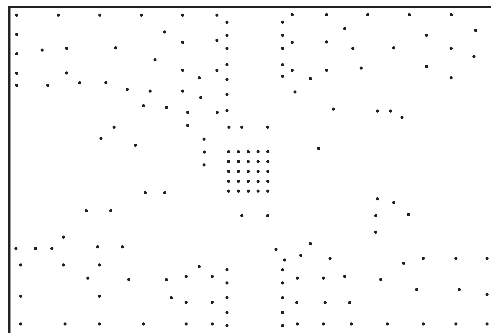

Layer 3: Inner Traces

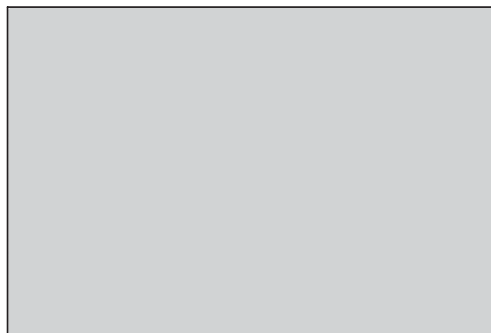

Layer 4: Ground

S590

Figure 14. Evaluation Board Layer Detail

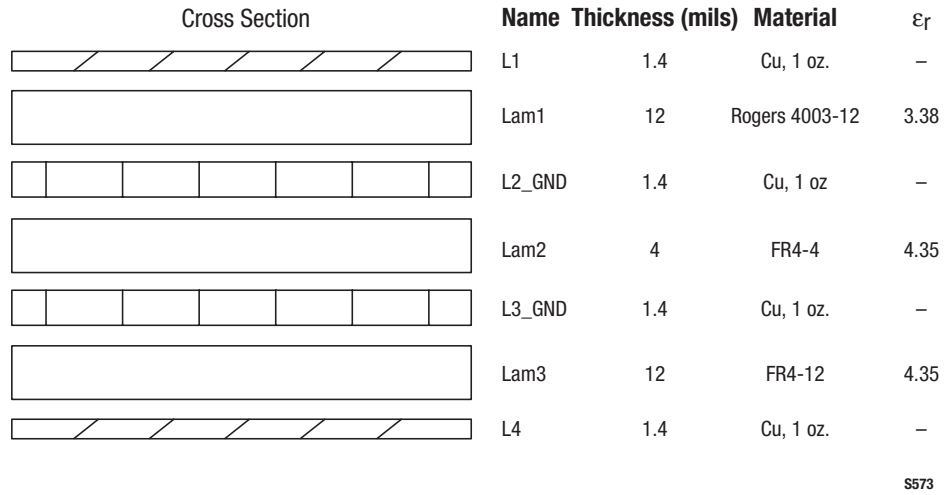
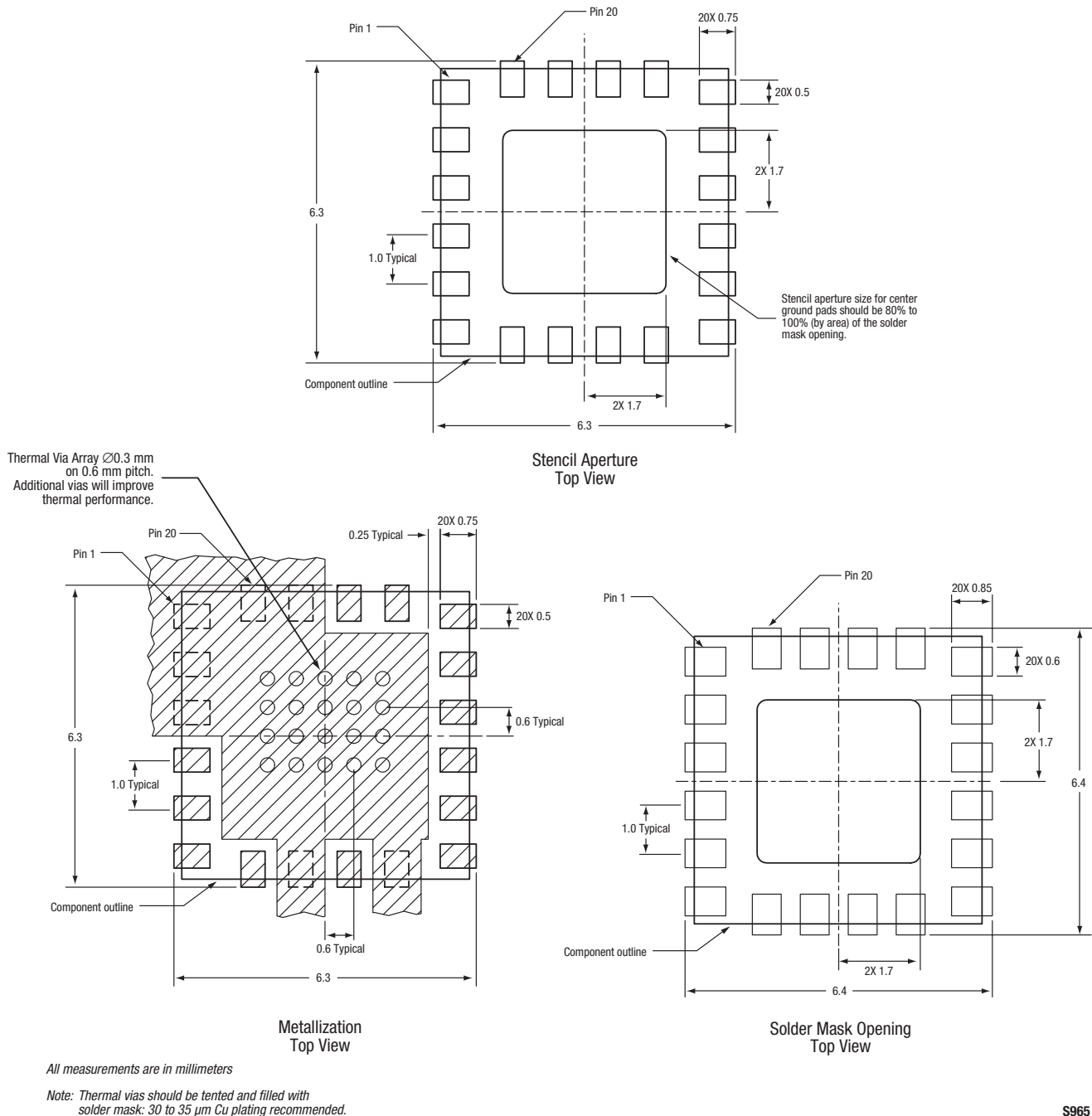
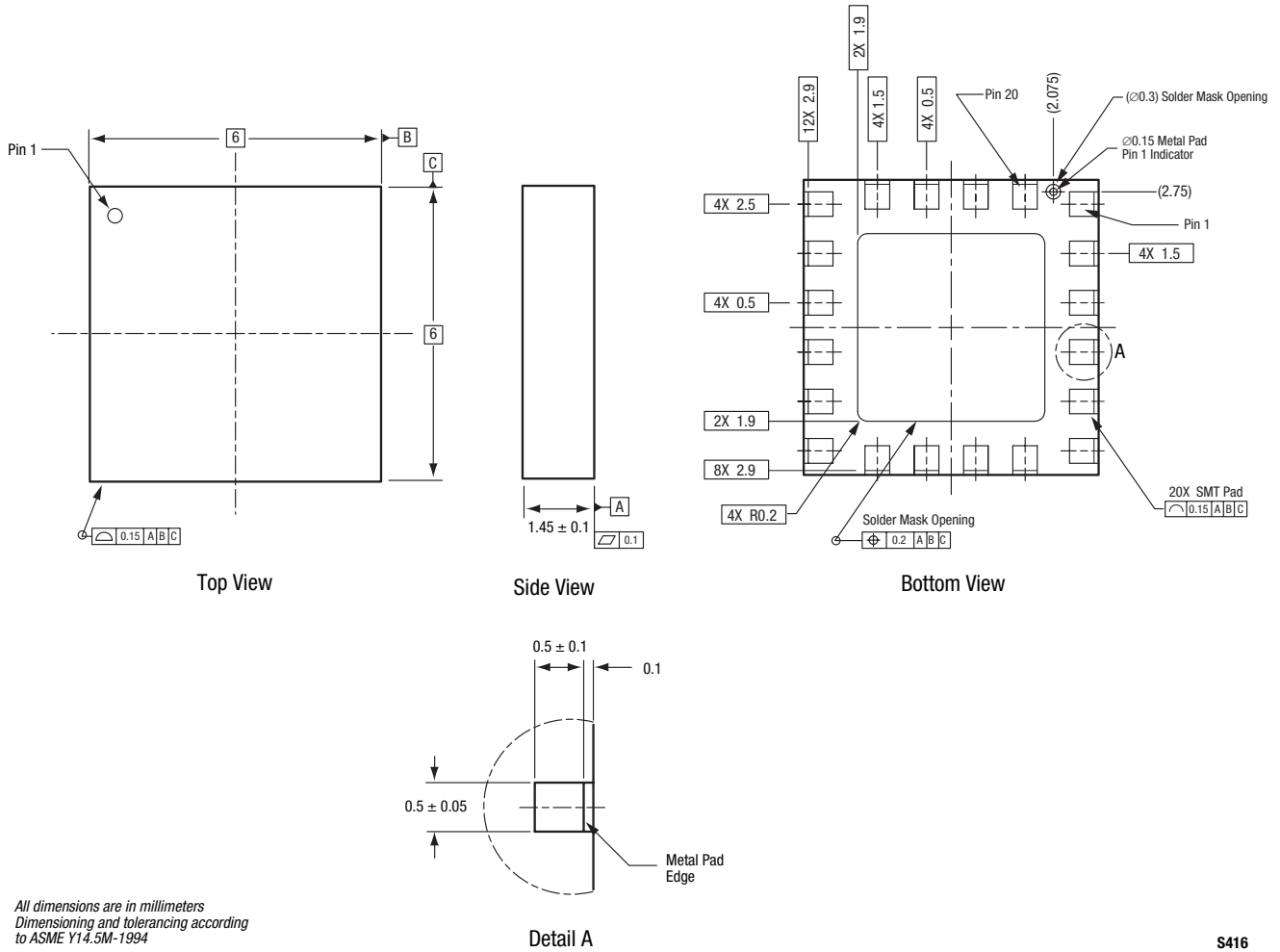

Figure 15. Layer Detail Physical Characteristics



S965

Figure 16. SKY65135 Phone Board Layout Footprint



S416

Figure 17. SKY65135 20-Pin MCM Package Dimensions

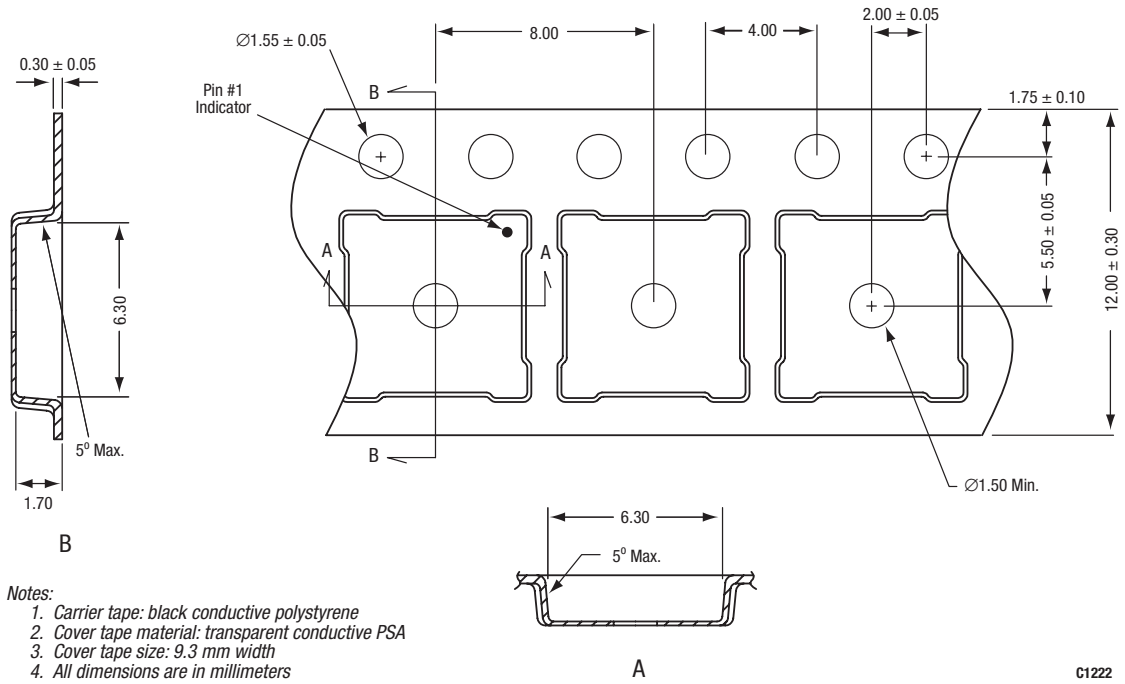

Figure 18. SKY65135 20-Pin MCM Tape and Reel Dimensions

Ordering Information

Model Name	Manufacturing Part Number	Evaluation Kit Part Number
SKY65135 WLAN Power Amplifier	SKY65135-21 (Pb-free package)	TW13-D122

Copyright © 2005, 2006, 2007 Skyworks Solutions, Inc. All Rights Reserved.

Information in this document is provided in connection with Skyworks Solutions, Inc. (“Skyworks”) products or services. These materials, including the information contained herein, are provided by Skyworks as a service to its customers and may be used for informational purposes only by the customer. Skyworks assumes no responsibility for errors or omissions in these materials or the information contained herein. Skyworks may change its documentation, products, services, specifications or product descriptions at any time, without notice. Skyworks makes no commitment to update the materials or information and shall have no responsibility whatsoever for conflicts, incompatibilities, or other difficulties arising from any future changes.

No license, whether express, implied, by estoppel or otherwise, is granted to any intellectual property rights by this document. Skyworks assumes no liability for any materials, products or information provided hereunder, including the sale, distribution, reproduction or use of Skyworks products, information or materials, except as may be provided in Skyworks Terms and Conditions of Sale.

THE MATERIALS, PRODUCTS AND INFORMATION ARE PROVIDED “AS IS” WITHOUT WARRANTY OF ANY KIND, WHETHER EXPRESS, IMPLIED, STATUTORY, OR OTHERWISE, INCLUDING FITNESS FOR A PARTICULAR PURPOSE OR USE, MERCHANTABILITY, PERFORMANCE, QUALITY OR NON-INFRINGEMENT OF ANY INTELLECTUAL PROPERTY RIGHT; ALL SUCH WARRANTIES ARE HEREBY EXPRESSLY DISCLAIMED. SKYWORKS DOES NOT WARRANT THE ACCURACY OR COMPLETENESS OF THE INFORMATION, TEXT, GRAPHICS OR OTHER ITEMS CONTAINED WITHIN THESE MATERIALS. SKYWORKS SHALL NOT BE LIABLE FOR ANY DAMAGES, INCLUDING BUT NOT LIMITED TO ANY SPECIAL, INDIRECT, INCIDENTAL, STATUTORY, OR CONSEQUENTIAL DAMAGES, INCLUDING WITHOUT LIMITATION, LOST REVENUES OR LOST PROFITS THAT MAY RESULT FROM THE USE OF THE MATERIALS OR INFORMATION, WHETHER OR NOT THE RECIPIENT OF MATERIALS HAS BEEN ADVISED OF THE POSSIBILITY OF SUCH DAMAGE.

Skyworks products are not intended for use in medical, lifesaving or life-sustaining applications, or other equipment in which the failure of the Skyworks products could lead to personal injury, death, physical or environmental damage. Skyworks customers using or selling Skyworks products for use in such applications do so at their own risk and agree to fully indemnify Skyworks for any damages resulting from such improper use or sale.

Customers are responsible for their products and applications using Skyworks products, which may deviate from published specifications as a result of design defects, errors, or operation of products outside of published parameters or design specifications. Customers should include design and operating safeguards to minimize these and other risks. Skyworks assumes no liability for applications assistance, customer product design, or damage to any equipment resulting from the use of Skyworks products outside of stated published specifications or parameters.

Skyworks, the Skyworks symbol, and “Breakthrough Simplicity” are trademarks or registered trademarks of Skyworks Solutions, Inc., in the United States and other countries. Third-party brands and names are for identification purposes only, and are the property of their respective owners. Additional information, including relevant terms and conditions, posted at www.skyworksinc.com, are incorporated by reference.