

RoHS  **HF 466 Series Fuse**

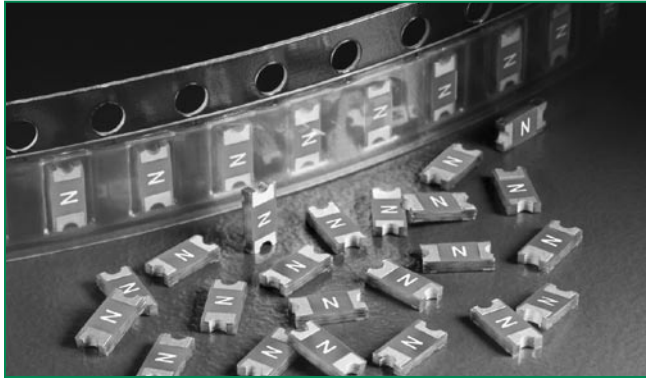

Description



The 466 Series Fast-Acting Surface Mount Fuse (SMF) is a small (1206 size) thin-film device designed for secondary protection of circuits used in space constrained applications such as hand-held portable electronic devices.

This series is 100% lead-free and meets the requirements of the RoHS directive. New Halogen-Free 466 Series fuses are available to order using the "HF" suffix. See Part Numbering section for additional information.

Features

- Product is compatible with lead-free solders and higher temperature profiles
- Product is marked on top surface with code to allow amperage rating identification without testing
- Low profile for height sensitive applications
- Flat top surface for pick-and-place operations
- Element-covering material is resistant to industry standard cleaning operations
- Mounting pad and electrical performance are identical to Littelfuse 429 and 433 Series products
- Alloy-based element construction provides superior inrush withstand characteristics (I^2t) over ceramic or glass-based 1206 chip fuse products

Agency Approvals

AGENCY	AGENCY FILE NUMBER	AMPERE RANGE
	E10480	125mA - 5A
	LR29862	125mA - 5A

Electrical Characteristics for Series



% of Ampere Rating	Opening Time at 25°C
100%	4 hours, Minimum
200%	5 sec., Maximum
300%	0.2 sec., Maximum

Applications

Secondary protection for space constrained applications:

- Cell phones
- Battery packs
- Digital cameras
- DVD players
- Hard disk drives

Electrical Specifications by Item

Ampere Rating (A)	Amp Code	Max Voltage Rating (V)	Interrupting Rating	Nominal Cold Resistance (Ohms)	Nominal Melting I^2t (A ² sec)	Nom Voltage Drop (mV)	Nom Power Dissipation (W)	Agency Approvals	
									
0.125	.125	125	50A @125 V AC/DC	4.000	0.00040	552.66	0.0691	x	x
0.200	.200	125		1.160	0.00055	254.28	0.0509	x	x
0.250	.250	125		0.710	0.0010	207.01	0.0518	x	x
0.375	.375	125	50A @63 V AC/DC	0.350	0.0028	169.18	0.0634	x	x
0.500	.500	63		0.248	0.0060	158.47	0.0792	x	x
0.750	.750	63		0.111	0.0276	98.65	0.0740	x	x
1.00	001.	63		0.076	0.0423	89.94	0.0899	x	x
1.25	1.25	63		0.059	0.0640	85.71	0.1071	x	x
1.50	01.5	63		0.048	0.1103	82.97	0.1244	x	x
1.75	1.75	63	50A @32 V AC/DC	0.039	0.1323	80.73	0.1413	x	x
2.00	002.	63		0.031	0.2326	78.73	0.1575	x	x
2.50	02.5	32		0.024	0.3516	76.99	0.1925	x	x
3.00	003.	32		0.020	0.5760	75.99	0.2280	x	x
4.00	004.	32		0.014	1.024	74.50	0.2980	x	x
5.00	005.	32	0.011	1.600	73.75	0.3688	x	x	

1. Measured at 10% of rated current, 25°C.
 2. Measured at rated voltage.

Temperature Derating Curve

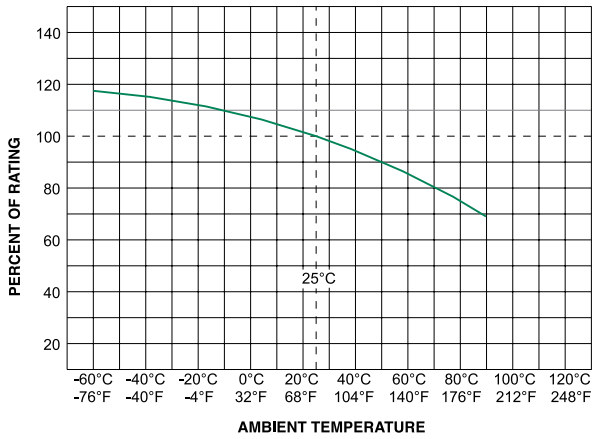

Note:

1. Derating depicted in this curve is in addition to the standard rating of 25% for continuous operation.

Example:

For continuous operation at 70 degrees celsius, the fuse should be rated as follows:

$$I = (0.75)(0.80)I_{RAT} = (0.60)I_{RAT}$$

2. The temperature derating curve represents the nominal conditions. For questions about temperature derating curve, please consult Littelfuse technical support for assistance.

Average Time Current Curves

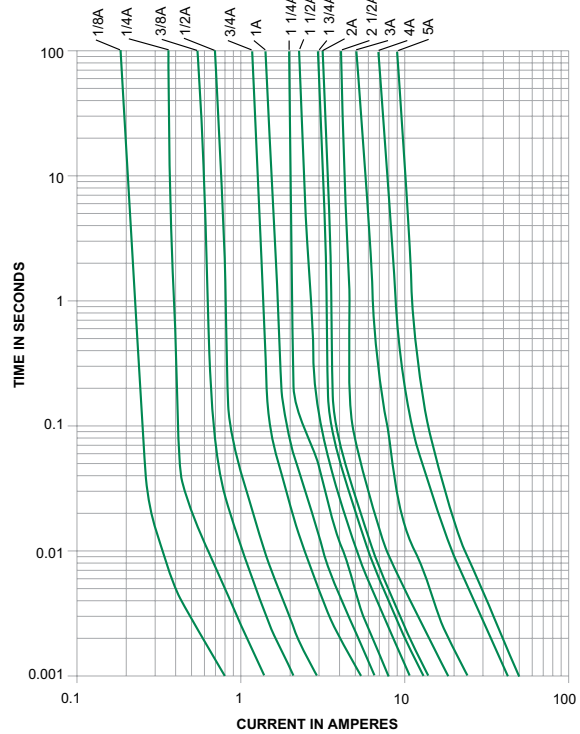

Soldering Parameters

Reflow Condition		Pb – free assembly
Pre Heat	- Temperature Min ($T_{s(min)}$)	150°C
	- Temperature Max ($T_{s(max)}$)	200°C
	- Time (Min to Max) (t_s)	60 – 180 seconds
Average Ramp-up Rate (Liquidus Temp (T_L) to peak)		5°C/second max.
$T_{s(max)}$ to T_L - Ramp-up Rate		5°C/second max.
Reflow	- Temperature (T_L) (Liquidus)	217°C
	- Temperature (t_L)	60 – 150 seconds
Peak Temperature (T_p)		250 ^{+0/-5} °C
Time within 5°C of actual peak Temperature (t_p)		20 – 40 seconds
Ramp-down Rate		5°C/second max.
Time 25°C to peak Temperature (T_p)		8 minutes max.
Do not exceed		260°C

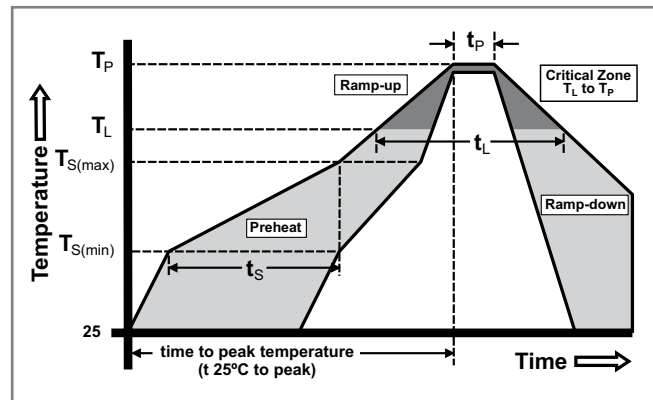

Wave Soldering

260°C, 10 seconds max.

Product Characteristics

Materials	Body: Advanced High Temperature Substrate Terminations: 100% Tin over Nickel over Copper Element Cover Coat: Conformal Coating
Operating Temperature	- 55°C to 90°C. Consult temperature derating curve chart.
Thermal Shock	Withstands 5 cycles of -55°C to 125°C
Humidity	MIL-STD-202F, Method 103B, Condition D

Vibration	Per MIL-STD-202F, Method 201A
Insulation Resistance (After Opening)	Greater than 10,000 ohms
Resistance to Soldering Heat	MIL-STD-202G, Method 210F, Condition D

Dimensions

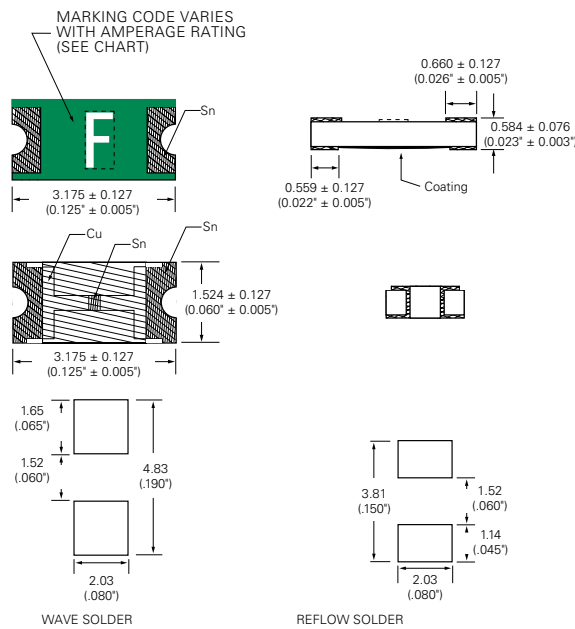

Part Marking System

Amp Code	Marking Code
.125	B
.200	C
.250	D
.375	E
.500	F
.750	G
001.	H
1.25	J
01.5	K
1.75	L
002.	N
02.5	O
003.	P
004.	S
005.	T

Part Numbering System

0466002.NRHF

SERIES

AMP Code

Refer to Amp Code column in the Electrical Specifications table. The dot is positioned before the Packaging Suffix with whole ratings and within the numbering sequence for fractional ratings.

QUANTITY Code

N = 5000 pcs

PACKAGING Code

R = Tape and Reel

'HF' SUFFIX

HALOGEN FREE ITEM

Example:

.125 amp product is 0466.**125** NR HF (2 amp product shown above).

Packaging

Packaging Option	Packaging Specification	Quantity	Quantity & Packaging Code
8mm Tape and Reel	EIA-481 Rev. D (IEC 60286, part 3)	5000	NR