

ML483

0.7 – 1.0 GHz High IP3 Mixer with Integrated LO Amp

Applications

- 2G/3G/4G Wireless Infrastructure
- Base station Transceivers / Repeaters
- GSM / CDMA / WCDMA / LTE
- HPA Feedback Paths
- ISM (industrial, scientific and medical)

Product Features

- High dynamic range mixer with integrated LO driver
- +36 dBm Input IP3
- 9 dB Conversion Loss
- RF: 700 – 1000 MHz
- LO: 540 – 1300 MHz
- IF: 70 – 300 MHz
- +5V Supply @ 50 mA
- 0 dBm Drive Level
- RoHS-compliant MSOP-8 (14mm²)

General Description

The ML483 high linearity converter combines a passive GaAs FET mixer with an integrated LO driver in an ultra-small lead-free/green/RoHS-compliant MSOP-8 package. The double-balanced integrated IC is able to operate across a 0.7-1.0 GHz frequency range to achieve +36 dBm Input IP3 while drawing a very low 50mA current. The ML483 can be used as an upconverter or downconverter in a low-side or high-side LO configuration.

A LO buffer amplifier is integrated on the chip to allow for operation directly from a synthesizer requiring only 0 dBm of drive level. The dual-stage LO driver provides a stable input power level into the mixer to allow for consistent performance over a wide range of LO power levels. The converter requires no external baluns and supports a wide range of IF frequencies.

Typical applications include frequency up/down conversion, modulation and demodulation for receivers and transmitters used in 2.5G and 3G mobile infrastructure. Due to the wide frequency range of operation, the converter can also be used for ISM and fixed wireless applications.

The ML483 is footprint and pin compatible with TriQuint's 1.6-3.2 GHz ML485 mixer for high band applications.



8-pin MSOP-8 package

Functional Block Diagram

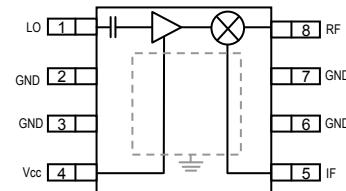

Pin Configuration

Pin #	Symbol
1	LO
4	Vcc
5	IF
8	RF
2, 3, 6, 7	GND
Backside Paddle	GND

Ordering Information

Part No.	Description
ML483-G	0.7-1.0 GHz Mixer
ML483-PCB	Fully Assembled Evaluation PCB

Standard T/R size = 1000 pieces on a 7" reel.

Specifications

Absolute Maximum Ratings

Parameter	Rating
Storage Temperature	-65 to 150 °C
Thermal Resistance (jnc. to case) θ_{jc}	81 °C/W
V_{cc}	+7 V
LO Power	+10 dBm
RF Input Power, CW, 50 Ω , T = 25°C	+27 dBm

Operation of this device outside the parameter ranges given above may cause permanent damage.

Recommended Operating Conditions

Parameter	Min	Typ	Max	Units
V_{cc}	4.75	5	5.25	V
I_{cc}		50		mA
Case Temperature	-40		85	°C
Max T_J (for 10 ⁶ hours MTTF)		150		°C
RF Input Power			+10	dBm

Electrical specifications are measured at specified test conditions. Specifications are not guaranteed over all recommended operating conditions.

Electrical Specifications

Test conditions unless otherwise noted: 25 °C, 0 dBm LO drive, IF = 140 MHz, V_{cc} = +5V in a downconverting configuration with a high-side LO

Parameter	Units	Min	Typ	Max	Min	Typ	Max
RF Frequency Range	MHz		700-800			800-1000	
LO Frequency Range	MHz		770-1040			870-1240	
IF Frequency Range	MHz		70-240			70-240	
SSB Conversion Loss [2]	dB		9.2			8.6	10.5
Input IP3 [1] [2]	dBm		+37		+30	+36	
LO leakage at RF port	dBm		-17			-18	
LO leakage at IF port	dBm		-11			-15	
RF – IF Isolation	dB		12.5			16	
Return Loss: RF Port	dB		13			16	
Return Loss: IF Port	dB		11			12	
Return Loss: LO Port	dB		11			14	
Input P1dB	dBm		+24			+23.5	
LO Drive Level	dBm	-4	0	+4	-4	0	+4
Operating Supply Voltage	V		+5			+5	
Operating Current	mA		50			50	

Notes:

1. IIP3 is measured with $\Delta f = 1$ MHz with $RF_{in} = 0$ dBm / tone.
2. Min/Max conditions tested with LO=1041 MHz, RF=901 MHz, IF=140 MHz

ML483

0.7 – 1.0 GHz High IP3 Mixer with Integrated LO Amp



Device Characterization Data

Spur Table

All spur tables are $N \times f_{RF} - M \times f_{LO}$ mixer spurious products for 0 dBm input power, unless otherwise noted.

RF Freq = 900 MHz

LO Freq = 1041 MHz

All values relative to the IF power level.

		M					
		0	1	2	3	4	5
N	0	--	8 dBc	13 dBc	15 dBc	10 dBc	9 dBc
	1	8 dBc	0 dBc	43 dBc	19 dBc	34 dBc	22 dBc
	2	54 dBc	59 dBc	44 dBc	65 dBc	53 dBc	64 dBc
	3	85 dBc	91 dBc	87 dBc	79 dBc	91 dBc	84 dBc
	4	99 dBc	100 dBc	100 dBc	99 dBc	100 dBc	98 dBc
	5	101 dBc	100 dBc	97 dBc	99 dBc	99 dBc	100 dBc

Application Circuit

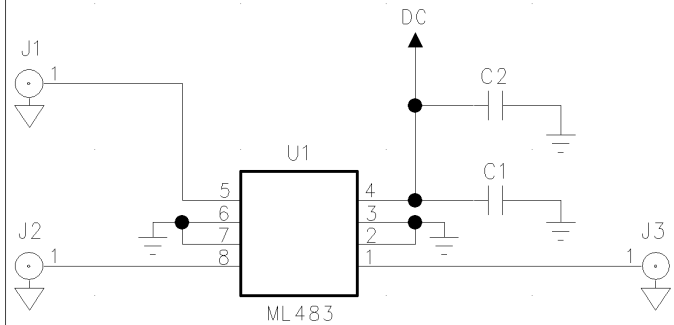
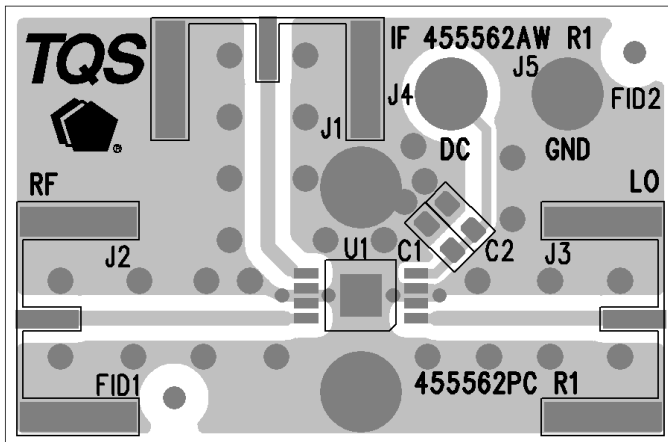

Notes:

- See PC Board Layout, page 6 for more information.

Bill of Material

Reference Desg.	Value	Description	Manufacturer	Part Number
U1		High IP3 Mixer with LO Amp	TriQuint	ML483-G
C1	0.01 uF	Chip, 0603, 50V, 5%, NPO	various	
C2		Do Not Place		

ML483

0.7 – 1.0 GHz High IP3 Mixer with Integrated LO Amp



Typical Performance 0.7-1.0 GHz

Performance using the circuitry on the ML483-PCB evaluation board.

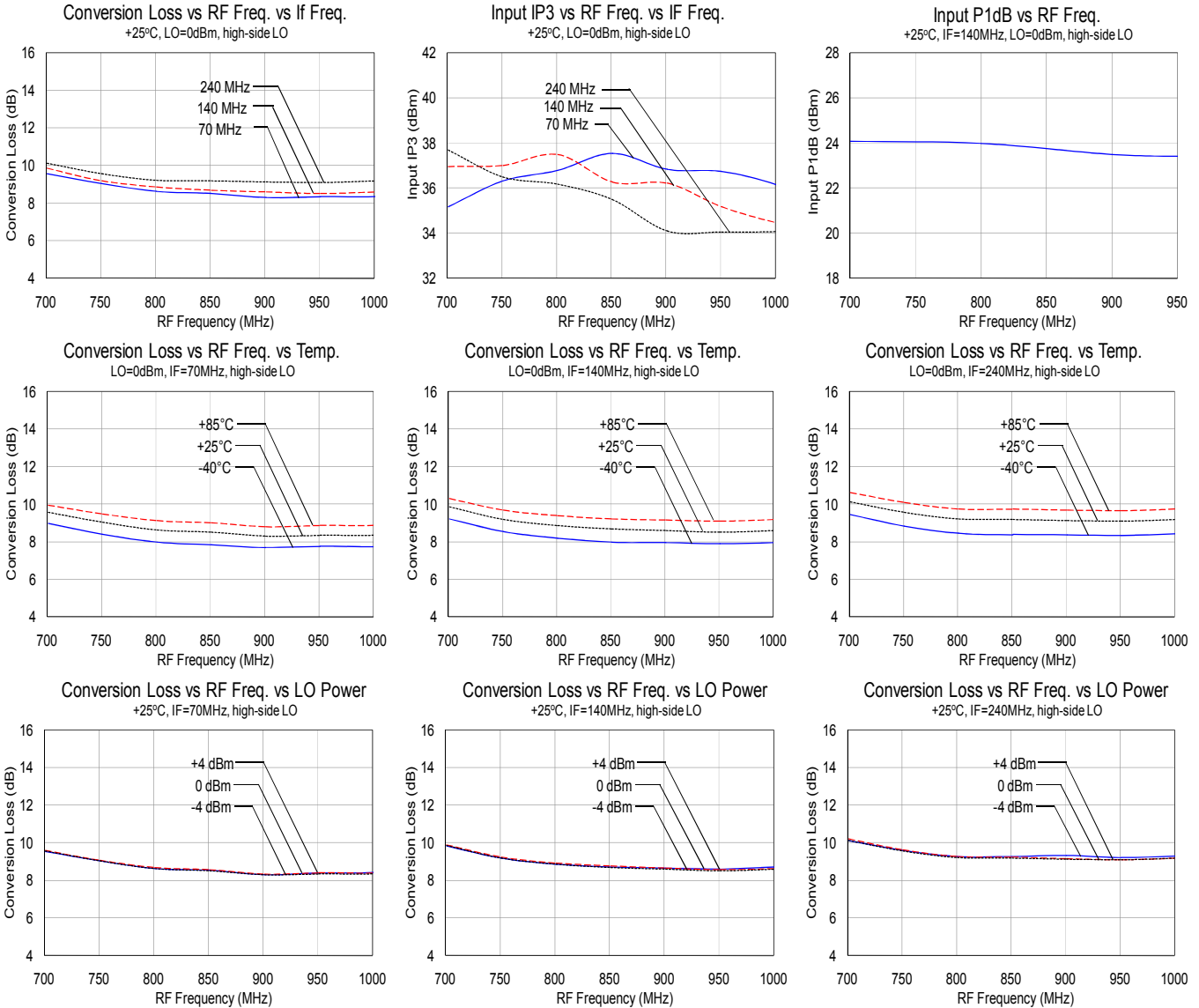

ML483

0.7 – 1.0 GHz High IP3 Mixer with Integrated LO Amp



Typical Performance 0.7-1.0 GHz

Performance using the circuitry on the ML483-PCB evaluation board.

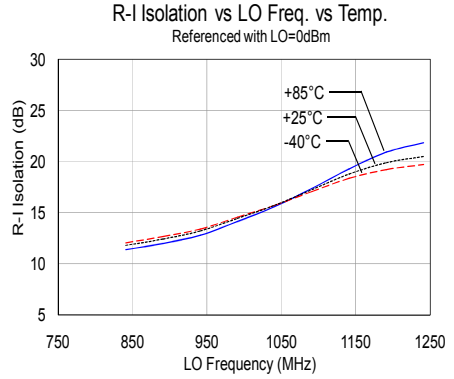
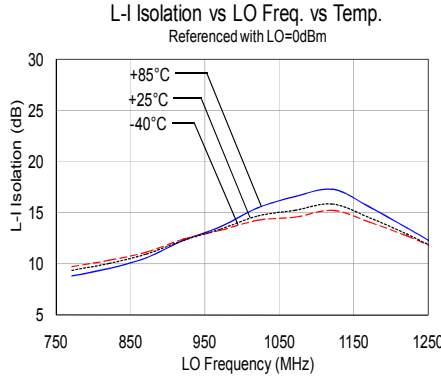
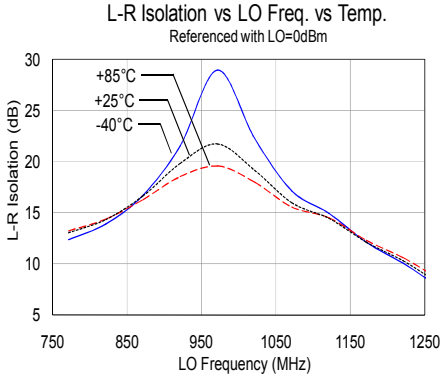
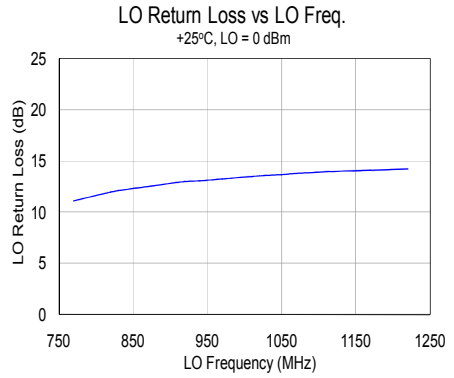
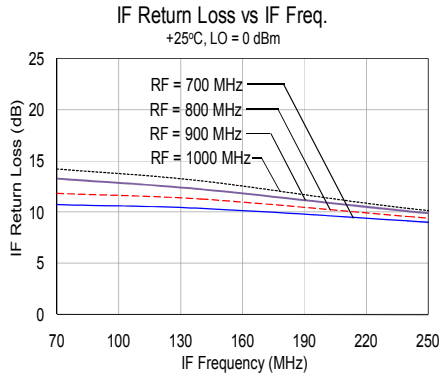
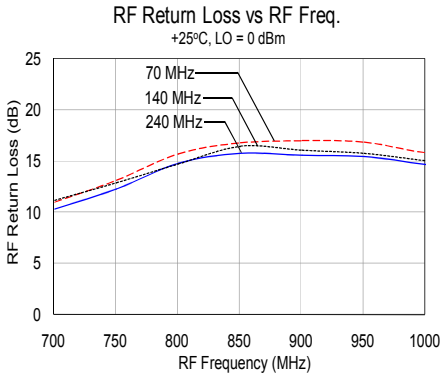
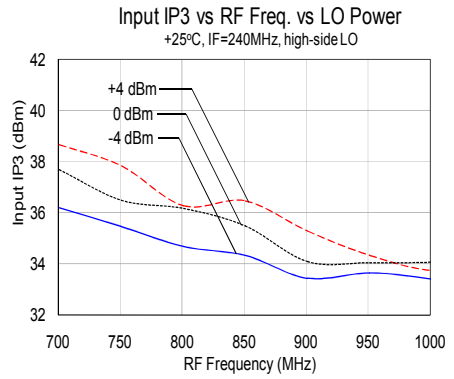
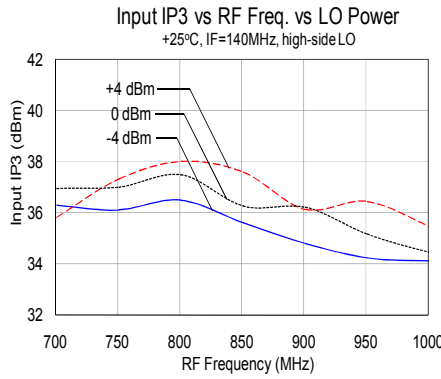
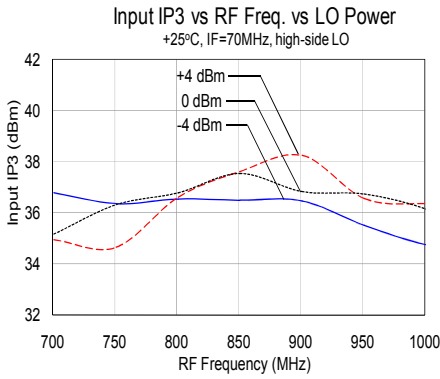
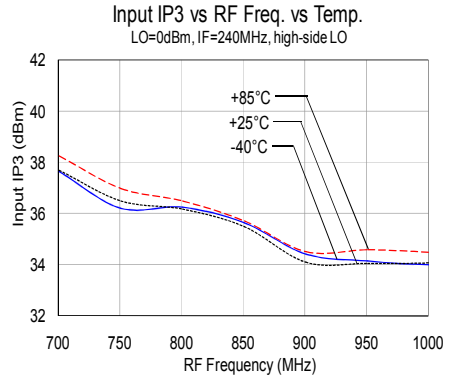
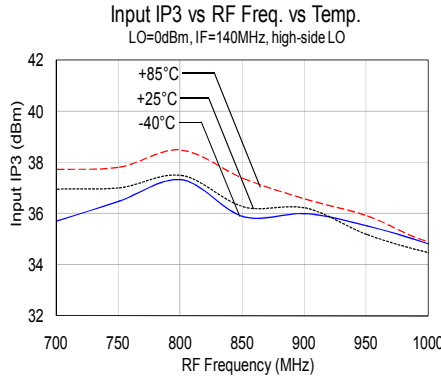
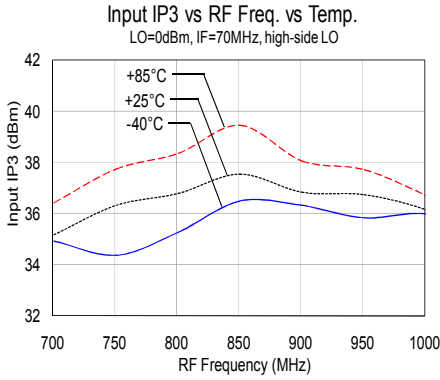

ML483

0.7 – 1.0 GHz High IP3 Mixer with Integrated LO Amp

Pin Description

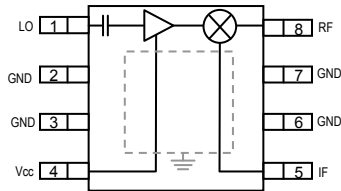

Pin	Symbol	Description
1	LO	Local Oscillator (LO) Input. Internally matched to 50 Ω. Internally DC blocked. External blocking not required.
2	GND	Ground
3	GND	Ground
4	Vcc	Positive Supply Voltage. Requires capacitive decoupling at pin.
5	IF	Intermediate Frequency (IF) Output. Internally matched to 50 Ω. No Internal DC blocking. External blocking cap required if DC present.
6	GND	Ground
7	GND	Ground
8	RF	RF Input. Internally matched to 50 Ω. No Internal DC blocking. External blocking cap required if DC present.
	Backside Paddle	Ground

Applications Information

PC Board Layout

Top RF layer is .014” FR4, $\epsilon_r = 4.3$, 4 total layers (0.062” thick) for mechanical rigidity. Metal layers are 1-oz copper. Microstrip line details: width = .026”, spacing = .026”.

The ML483 application board is easy to use requiring only 1 external decoupling cap. This cap should be placed as close as possible to Vcc pin 4. All three ports use 50 Ω microstrip. There are 5 grounding vias that are not shown. The backside paddle requires these 5 vias for good RF grounding. The mechanical configuration diagram on the next page illustrates proper placement of these vias.

The pad pattern shown has been developed and tested for optimized assembly at TriQuint Semiconductor. The PCB land pattern has been developed to accommodate lead and package tolerances. Since surface mount processes vary from company to company, careful process development is recommended.

For further technical information, Refer to www.TriQuint.com

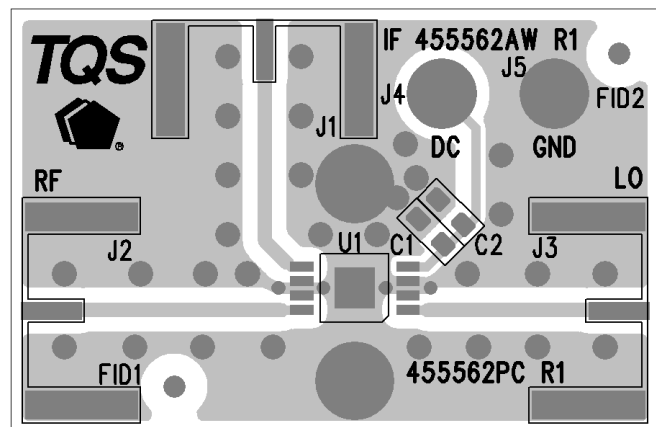

ML483

0.7 – 1.0 GHz High IP3 Mixer with Integrated LO Amp



Mechanical Information

Package Information and Dimensions

This package is lead-free/green/RoHS-compliant. The plating material on the leads is matte tin. It is compatible with both lead-free (maximum 260 °C reflow temperature) and lead (maximum 245 °C reflow temperature) soldering processes.

The component will be laser marked with a “M43” product label with an alphanumeric lot code on the top surface of the package.

Notes:

1. All dimensions are in millimeters (inches).
2. Package length does not include mold flash, protrusions or gate burr.
3. Package width does not include interlead flash or protrusions.

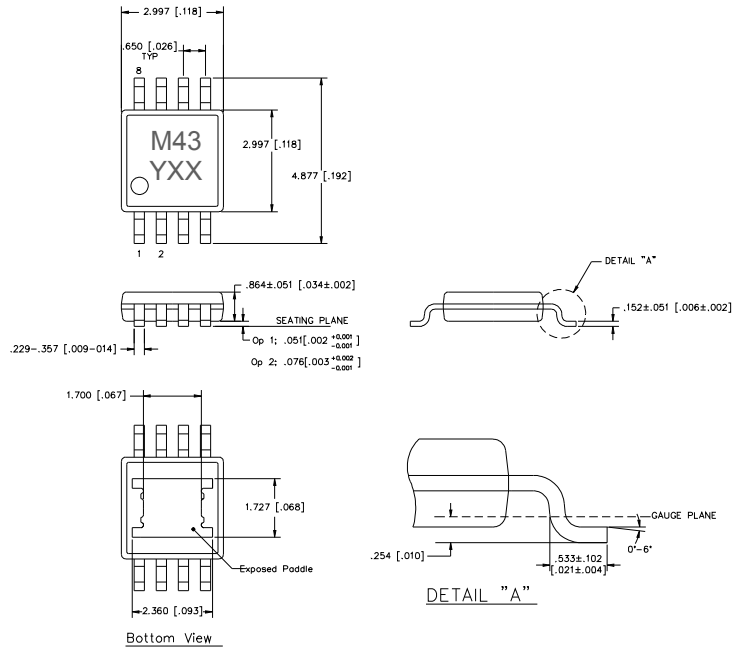

Mounting Configuration

All dimensions are in millimeters (inches). Angles are in degrees.

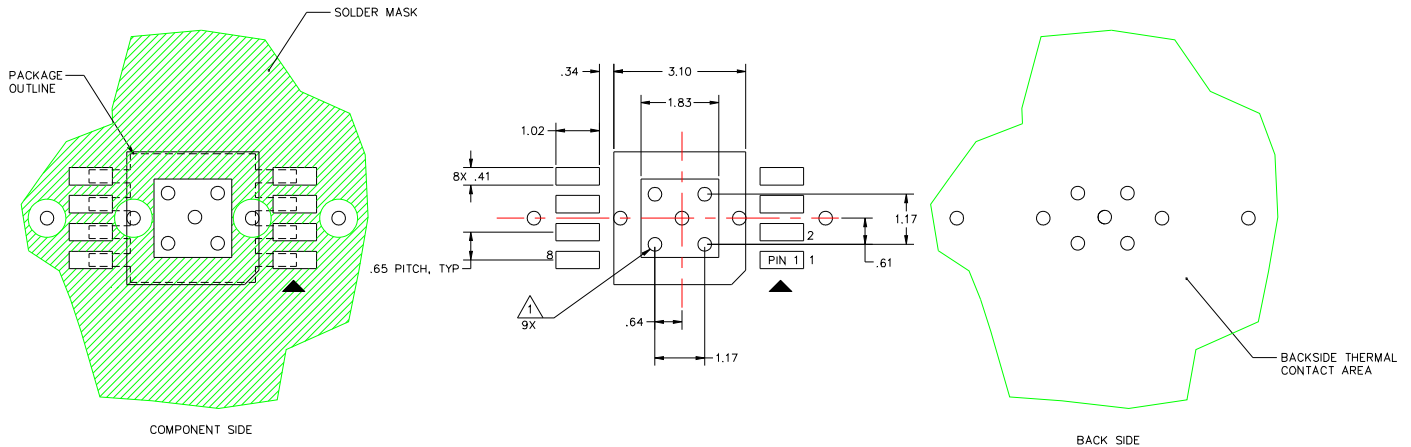

Notes:

1. Vias shown use a .35mm (#80 / .0135") diameter drill and have a final plated thru diameter of .25 mm (.010"). Other via sizes are possible.
2. To ensure reliable operation, device ground paddle-to-ground pad solder joint is critical.
3. RF trace width for 50 Ω depends upon the PC board material and construction.

Product Compliance Information

ESD Information



Caution! ESD-Sensitive Device

ESD Rating: Class 1A
Value: Passes/ 250 V to < 500 V
Test: Human Body Model (HBM)
Standard: JEDEC Standard JESD22-A114

ESD Rating: Class 3
Value: Passes \geq 500 V to < 1000 V
Test: Charged Device Model (CDM)
Standard: JEDEC Standard JESD22-C101

MSL Rating

Level 2 at +260 °C convection reflow.

The part is rated Moisture Sensitivity Level 2 at 260°C per JEDEC standard IPC/JEDEC J-STD-020.

Solderability

Compatible with the latest version of J-STD-020, Lead free solder, 260°

This part is compliant with EU 2002/95/EC RoHS directive (Restrictions on the Use of Certain Hazardous Substances in Electrical and Electronic Equipment).

This product also has the following attributes:

- Lead Free
- Halogen Free (Chlorine, Bromine)

Contact Information

For the latest specifications, additional product information, worldwide sales and distribution locations, and information about TriQuint:

Web: www.triquint.com
Email: info-sales@tqs.com

Tel: +1.503.615.9000
Fax: +1.503.615.8902

For technical questions and application information:

Email: sjapplication.engineering@tqs.com

Important Notice

The information contained herein is believed to be reliable. TriQuint makes no warranties regarding the information contained herein. TriQuint assumes no responsibility or liability whatsoever for any of the information contained herein. TriQuint assumes no responsibility or liability whatsoever for the use of the information contained herein. The information contained herein is provided "AS IS, WHERE IS" and with all faults, and the entire risk associated with such information is entirely with the user. All information contained herein is subject to change without notice. Customers should obtain and verify the latest relevant information before placing orders for TriQuint products. The information contained herein or any use of such information does not grant, explicitly or implicitly, to any party any patent rights, licenses, or any other intellectual property rights, whether with regard to such information itself or anything described by such information.

TriQuint products are not warranted or authorized for use as critical components in medical, life-saving, or life-sustaining applications, or other applications where a failure would reasonably be expected to cause severe personal injury or death.