



APPLICATIONS

Wireless Network
Telecom/Datacom
Industry Control System
Distributed Power Architectures
Semiconductor Equipment
Microprocessor Power Applications

FEATURES

- OUTPUT CURRENT UP TO 6A
- SMALL SIZE AND LOW PROFILE :
0.80" X 0.45" X 0.22" (SMD) ; 0.9" X 0.40" X 0.20" (SIP)
- HIGH EFFICIENCY - 94% @ 3.3V FULL LOAD
- INPUT RANGE FROM 2.4VDC TO 5.5VDC
- FIXED SWITCHING FREQUENCY (300KHZ)
- SMD & SIP PACKAGES
- OUTPUT VOLTAGE PROGRAMMABLE FROM 0.75VDC TO 3.3VDC VIA EXTERNAL RESISTOR
- INPUT UNDER-VOLTAGE LOCKOUT
- UL60950-1, EN60950-1 AND IEC60950-1 LICENSED
- ISO9001 CERTIFIED MANUFACTURING FACILITIES
- COMPLIANT TO RoHS EU DIRECTIVE 2002/95/EC

OPTIONS

Positive Logic Remote on/off

DESCRIPTION

DOS06-05T (SMD type), DOH06-05T (for Vertical Mounting SIP type) and DOH06-05TA (for Horizontal Mounting SIP type) are non-isolated DC/DC converters that can deliver up to 6A of output current with full load efficiency of 94% at 3.3V output.

TECHNICAL SPECIFICATION All specifications are typical at nominal input, full load and 25°C otherwise noted

OUTPUT SPECIFICATIONS	
Output current	6A max
Voltage accuracy	Full load and Vin(nom) ± 2%Vo(set)
Minimum load	0%
Line regulation	$V_{in}=V_{o(set)}+0.5V$ to $V_{in(max)}$ at Full Load ± 0.3%Vo(set),typ
Load regulation	No Load to Full Load ± 0.4%Vo(set),typ
Ripple and noise (Note2)	20MHz bandwidth 20mVrms,max 50mVp-p,max
Temperature coefficient	±0.4%, typ
Dynamic load response (Note2)	$\Delta I_o / \Delta t = 2.5A/\mu S$, Vin(nom) Peak deviation 130mV,typ Load change step (50% to 100% or 100% to 50% of Io(max)) Setting time (Vo<10%peak deviation) 25μS,typ
	$\Delta I_o / \Delta t = 2.5A/\mu S$, Vin(nom) Peak deviation 50mV,typ Load change step (50% to 100% or 100% to 50% of Io(max)) Setting time (Vo<10%peak deviation) 50μS,typ
Dynamic load response (Note3)	$\Delta I_o / \Delta t = 2.5A/\mu S$, Vin(nom) Peak deviation 50mV,typ Load change step (50% to 100% or 100% to 50% of Io(max)) Setting time (Vo<10%peak deviation) 50μS,typ
Output current limit	220%,typ
Output short-circuit current	Hiccup, automatics recovery
External load capacitance	ESR ≥ 1mΩ 1000μF,max
	ESR ≥ 10mΩ 3000μF,max
Output voltage overshoot-startup	Vin=2.4~5.5V, F.L. 1%Vo(set)
Voltage adjustability (see fig.1)	(Note 4) 0.7525V ~ 3.63V
GENERAL SPECIFICATIONS	
Efficiency	See table
Isolation voltage	None
Switching frequency	300KHz, typ
Approvals and standard	IEC60950-1, UL60950-1, EN60950-1
Dimensions	SMD 0.80 X 0.45 X 0.22 Inch (20.3 X 11.4 X 5.5 mm)
	SIP 0.90 X 0.40 X 0.20 Inch (22.9 X 10.2 X 5.0 mm)
Weight	2.8g(0.1oz)
MTBF (Note 1)	BELLCORE TR-NWT-000332 2.133 x 10 ⁷ hrs
	MIL-HDBK-217F 3.247 x 10 ⁶ hrs

INPUT SPECIFICATIONS	
Input voltage range	Vo(set) < Vin - 0.5V 2.4 - 5.5VDC
Maximum input current	Vin=Vin(min); Vo(set)=3.3V; Io=Io(max) 6A
Input filter (Note 5)	C filter
Input no load current (Vin=5V, Io=0, module enabled)	Vo(set) =0.75Vdc 20mA,typ
	Vo(set) =3.3Vdc 45mA,typ
Input under voltage lockout	Start-up voltage 2.2V,typ Shutdown voltage 2.0V,typ
Input reflected ripple current	5~20MHz, 1μH source impedance 35mA _{p-p}
ENVIRONMENTAL SPECIFICATIONS	
Operating ambient temperature	-40°C ~ +85°C(with derating)
Storage temperature range	-55°C ~ +125°C
Thermal shock	MIL-STD-810F
Over temperature protection	135 °C, typ
FEATURE SPECIFICATIONS	
Remote ON/OFF(Note 6) (Negative logic)(standard)	ON = 0V < Vr < 0.3V I _{IN} =10μA, max
	OFF = 1.5V < Vr < Vin(max) I _{IN} =1mA, max
(Positive logic)(option)	ON = Vin(max) I _{IN} =10μA, max
	OFF=0V < Vr < 0.3V I _{IN} =1mA, max
Input current of Remote control pin	10μA~1.0mA
Remote off state input current	Nominal Vin 0.6mA,typ
Rise time	Time for Vo to rise from 10% to 90%of Vo(set) 6ms,max.
Turn-on delay time	Case 1 (Note 7) 1ms, typ
	Case 2 (Note 8) 1ms, typ

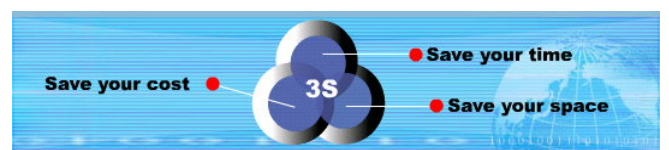



Model Name	ON/OFF Logic	Package	Input Voltage	Output Voltage	Output Current		Efficiency (%) 5.0Vin, 3.3Vdc@6A
					Min. Load	Max. Load	
DOS06-05T	Negative	SMD	2.4 ~ 5.5Vdc Vin(min)=Vo(set)+0.5V	0.75 ~ 3.3Vdc	0A	6A	94%
DOS06-05T-P	Positive						
DOH06-05T	Negative	Vertical Mounting					
DOH06-05T-P	Positive	SIP					
DOH06-05TA	Negative	Horizontal Mounting					
DOH06-05TA-P	Positive	SIP					

Note

- BELLCORE TR-NWT-000332. Case 1: 50% Stress, Temperature at 40°C.
MIL-HDBK-217F Notice2 @Ta=25 °C, Full load(Ground, Benign, controlled environment).
- External with C_{out} = 1μF ceramic//10μF tantalum capacitors.
- External with C_{out} = 2x150uF polymer capacitors.
- Output voltage programmable from 0.75V to 3.3V by connecting a single resistor (shown as R_{trim} in Table 1) between the TRIM and GND pins of the module. To calculate the value of the resistor **R_{trim}** for a particular output voltage **V_o**, use the following equation:

$$R_{trim} = \left[\frac{21070}{V_o - 0.7525} - 5110 \right] \Omega$$

- It's necessary to equip the external input capacitors at the input of the module. The capacitors should connect as close as possible to the input terminals that ensuring module stability. The external C_{in} is 2x150μF low-ESR polymer capacitors // 2x47μF ceramic capacitors at least.
- Device code with suffix "-P" – Positive logic(On/Off is open collector/drain logic input; Signal referenced to GND)
Device code with no suffix – Negative logic (On/Off pin is open collector/drain logic input with external pull –up resistor; signal referenced to GND)
- Case 1 :On/Off input is set to logic low (module on) and then input power is applied (delay from instant at which Vin=Vin(min) until Vo=10% of Vo(set))
- Case 2 :Input power is applied for at least one second and then the On/Off input is set to logic low (delay form instant at which Von/off=0.3V until Vo=10% of Vo(set))

CAUTION: This power module is not internally fused. An input line fuse must always be used.

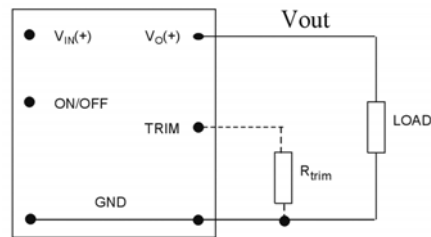
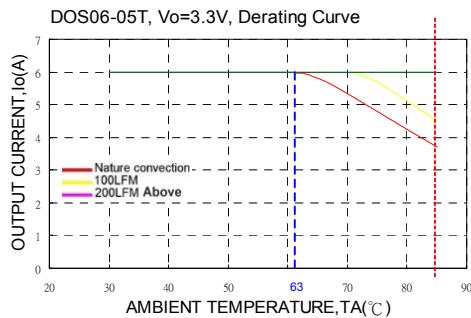
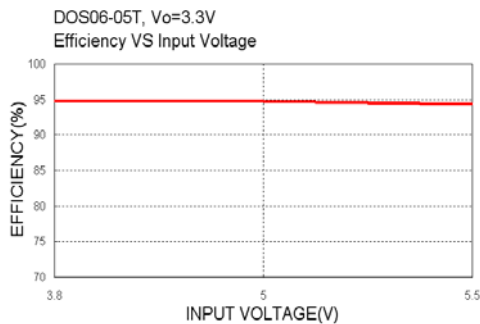
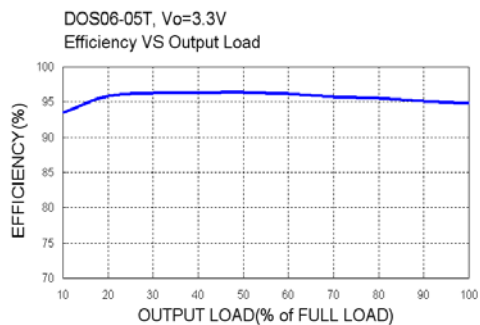

Fig. 1



Vo(set) (V)	Rtrim (KΩ)
0.7525	Open
1.2	41.973
1.5	23.077
1.8	15.004
2.5	6.974
3.3	3.160





DOH06-05T

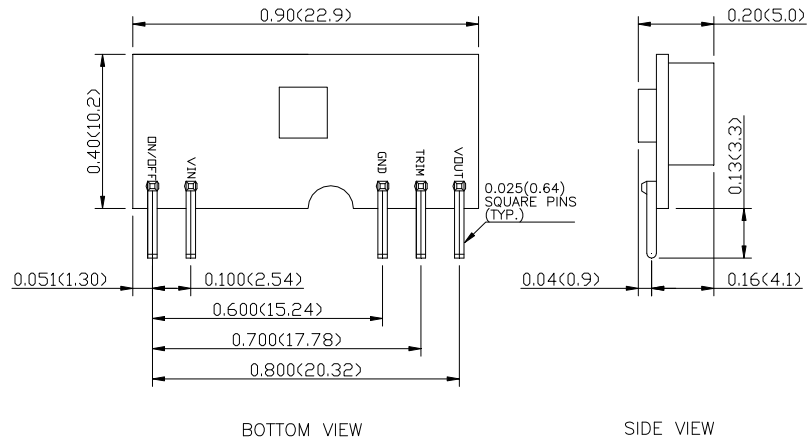

DOH06-05TA

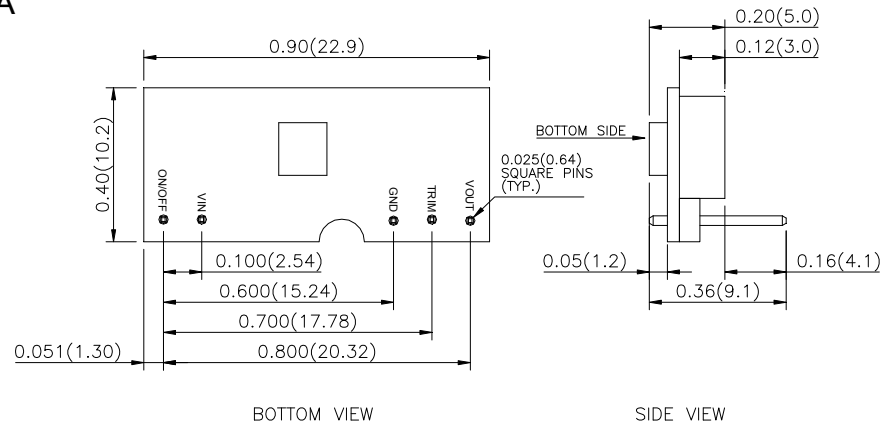

DOS06-05T

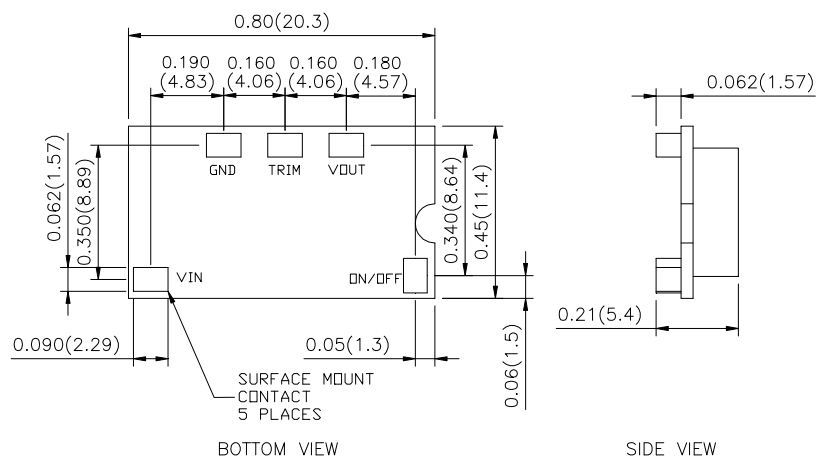

1. All dimensions in Inches (mm)
Tolerance: X.XX±0.02 (X.X±0.5)
X.XXX±0.01 (X.XX±0.25)
2. Pin pitch tolerance ±0.01(0.25)
3. Pin dimension tolerance ±0.004 (0.1)

