

SA65-0003

## Features

- LNA Mixer integration.
- Typical conversion gain of 7 dB.
- Typical Two-Tone IM Ratio of  $\geq 50$  dBm.
- LO Drive-Level: +13 dBm.
- Surface Mount QSOP16 Package.
- Low Cost/High Performance.
- 50 ohm Nominal Impedance.

## Description

M/A-COM's SA65-0003 is an integrated assembly containing a GaAs FET MMIC LNA and GaAs FET mixer. This device is packaged in a 16-leaded QSOP plastic surface mount package. The amplifier can be biased with either +3V or +5V, the mixer requires no DC bias. The conversion gain of the integrated combination is typically 6 dB at +3V bias and 8 dB at +5V bias. The SA65-0003 is ideally suited for RF/IF communications applications requiring down conversion with some gain.

This MCM contains a mixer that is fabricated using a mature 1-micron GaAs process, it also contains an LNA that is fabricated using a low cost mature 0.5-micron gate length GaAs MESFET process. Both die feature full passivation for increased performance and reliability.

## Functional Block Diagram

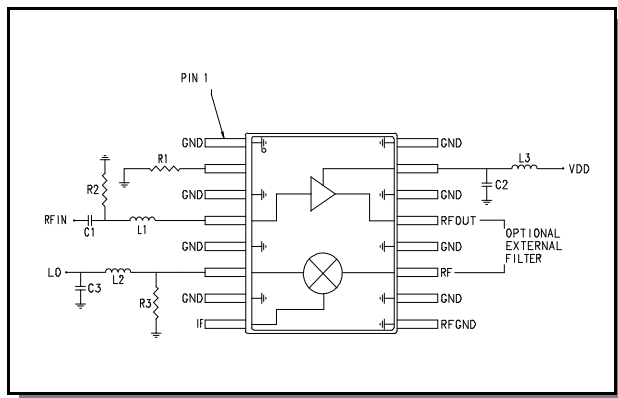

## QSOP-16

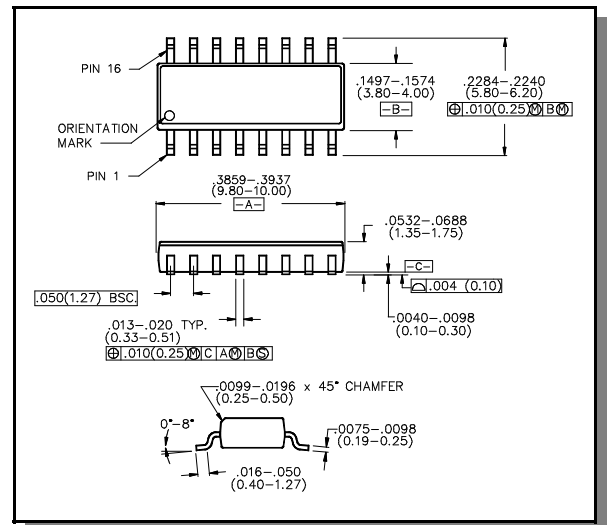

## Recommended PCB Layout

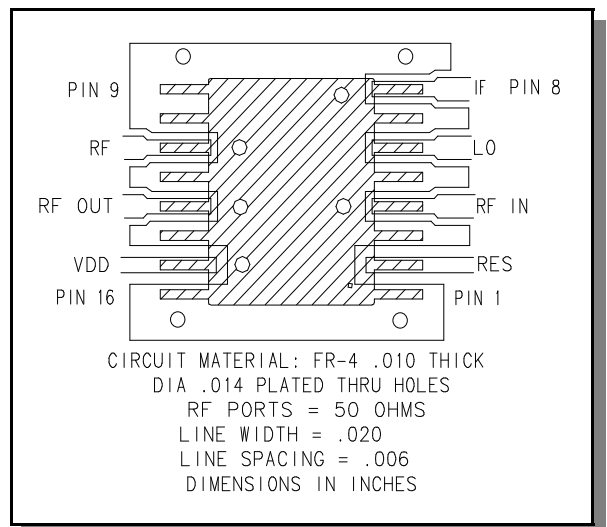

## Electrical Specifications $T_A = +25^\circ\text{C}$ , $Z_0=50\ \Omega$ , $RF = -10\ \text{dBm}^1$ , $LO = +13\ \text{dBm}$ , $I_{DD} \gg 45\ \text{mA}$

| Parameter                              | Test Conditions <sup>1</sup> | Units | Min | Typical | Max   |
|--|------------------------------|-------|-----|---------|-------|
| Conversion Gain <sup>6,7</sup>         | LNA +3V                      | dB    | 3.1 | 6.0     | 6.6   |
|  | LNA +5V                      | dB    | 4.6 | 8.0     | 8.8   |
| Isolation <sup>4</sup>                 | LO to RF IN                  | dB    | 29  | 32      | —     |
|  | LO to IF                     | dB    | 19  | 23      | —     |
| Reverse Isolation <sup>5</sup>         | LNA +3V                      | dB    | 30  | 40      | —     |
| VSWR                                   | LO                           | Ratio | —   | 1.4:1   | —     |
|  | RF IN                        | Ratio | —   | 1.9:1   | 2.5:1 |
|  | IF                           | Ratio | —   | 1.9:1   | 2.1:1 |
| Input IP <sub>3</sub> <sup>1,2,3</sup> | LNA +3V                      | dB    | 13  | 17.5    | —     |
|  | LNA +5V                      | dB    | 21  | 25      | —     |

- For IP<sub>3</sub> measurements, RFIN = -24 dBm, this low RF IN level gets amplified through the LNA.
- For IP<sub>3</sub> measurements, RFIN2 = RFIN1 + 10 MHz, LO = RFIN1—140 MHz.
- For IP<sub>3</sub> measurements, IP<sub>3</sub> = IMR/2 + PIN.
- RF IN to IF Isolation is typically 0 dB.
- Reverse Isolation is measured from IF to RFIN with the IF at -10 dBm, LO at +13 dBm.
- The amplifier has a normal gain of 12.5 dB, 3V bias and 14.0 dB, 5V bias. Amplifier typical Noise Figure = 1.5 dB.
- $NF_T = NF_1 + (NF_2 - 1)/G_1$

## Absolute Maximum Ratings<sup>8</sup>

| Parameter                         | Absolute Maximum |
|-----------------------------------|------------------|
| RF Input Power <sup>9</sup>       | +17 dBm          |
| LO Drive Power <sup>9</sup>       | +23 dBm          |
| V <sub>DD</sub>                   | +10 VDC          |
| Current <sup>10</sup>             | 80 mA            |
| Channel Temperature <sup>11</sup> | +150°C           |
| Operating Temperature             | -40°C to +85°C   |
| Storage Temperature               | -65°C to +150°C  |

- Operation of this device above any one of these parameters may cause permanent damage.
- Total power for RF and LO ports should not exceed +23 dBm.
- When pin #2 is used to increase current—see note 6 above.
- Thermal resistance ( $\theta_{jc}$ ) = +95°C/W.

## Pin Configuration

| Pin # | Function             | Description                         |
|-------|----------------------|-------------------------------------|
| 1     | GND                  | RF and DC Ground                    |
| 2     | RES                  | External current control (optional) |
| 3     | GND                  | RF and DC Ground                    |
| 4     | RF IN                | RF Input of the amplifier           |
| 5     | GND                  | RF and DC Ground                    |
| 6     | LO                   | LO port of the mixer                |
| 7     | GND                  | RF and DC Ground                    |
| 8     | IF                   | IF port of the mixer                |
| 9     | RF GND               | RF and DC Ground                    |
| 10    | GND                  | RF and DC Ground                    |
| 11    | RF <sup>12</sup>     | RF port of the mixer                |
| 12    | GND                  | RF and DC Ground                    |
| 13    | RF OUT <sup>12</sup> | RF output of the amplifier          |
| 14    | GND                  | RF and DC Ground                    |
| 15    | V <sub>DD</sub>      | Positive supply voltage             |
| 16    | GND                  | RF and DC Ground                    |

- The output port of the amplifier, RFOUT, and the input port of the mixer, RF, are adjacently placed so that an external filter can be used.

Specifications subject to change without notice.

- North America: Tel. (800) 366-2266
- Asia/Pacific: Tel.+81-44-844-8296, Fax +81-44-844-8298
- Europe: Tel. +44 (1344) 869 595, Fax+44 (1344) 300 020

Visit [www.macom.com](http://www.macom.com) for additional data sheets and product information.

External Circuitry Parts <sup>13</sup>

| Part | Value       | Purpose                  |
|------|-------------|--------------------------|
| C1   | 47 pF       | DC Block                 |
| C2   | 47 pF       | By-pass                  |
| C3   | 3.3 pF      | LO Port Matching Network |
| L1   | 3.9 nH      | Tuning                   |
| L2   | 3.0 nH      | LO Port Matching Network |
| L3   | 12 nH       | RF Choke                 |
| R1   | See Note 14 | Optional Current Control |
| R2   | 5.1 k Ohms  | DC Return                |
| R3   | 330 Ohms    | LO Port Matching Network |

- 13. All external circuitry parts are readily available, low cost surface mount components (.060 in. x .030 in. or .080 in. x .050 in.).
- 14. Pin 2 allows use of an external resistor to ground for optional higher current. For 20 mA operation, no resistor is used.
  - For  $I_{DD} \gg 30$  mA,  $R2 = 43$  Ohms
  - For  $I_{DD} \gg 45$  mA,  $R2 = 15$  Ohms
  - For  $I_{DD} \gg 60$  mA,  $R2 = 10$  Ohms

Spurious Table

|                    |    |      |     |     |     |     |
|--------------------|----|------|-----|-----|-----|-----|
| Harmonic of LO (n) |    | -12  | -37 | -65 | -75 | -75 |
|                    | 4X | -1.9 | -39 | -72 | -77 | -77 |
|                    |    | -2.8 | -29 | -68 | -66 | -74 |
|                    | 3X | 7.1  | -30 | -70 | -77 | -75 |
|                    |    | 7.0  | -27 | -37 | -68 | -74 |
|                    | 2X | 11.8 | -27 | -47 | -75 | -75 |
|                    |    | 4.5  | 0   | -48 | -69 | -74 |
|                    | 1X | 11.8 | 0   | -58 | -76 | -76 |
|                    |    | N/A  | -5  | -34 | -69 | -70 |
|                    | 0X | N/A  | -5  | -46 | -75 | -70 |

Harmonic of RFIN (m)

The spurious table shows the spurious signals resulting from the mixing of the RFIN and LO input signals, assuming down conversion. The number of dB below the conversion loss level indicates the mixing products. The lower frequency mixing term is shown for two different input levels. The top number is for an RFIN power level of -19 dB; the lower number is for -29 dB. Assuming the LNA gain is approximately 14 dB, the mixer input will see approximately -5 dB and -15 dB.

$$|mF_{RF} - nF_{LO}|, RF = -19 \text{ dB} \quad RF = 1850 \text{ MHz}$$

$$|mF_{RF} - nF_{LO}|, RF = -29 \text{ dB} \quad LO = 1710 \text{ MHz}$$

Typical Performance Curves

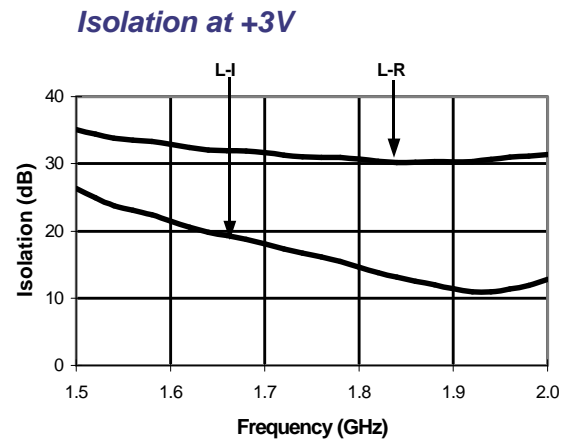
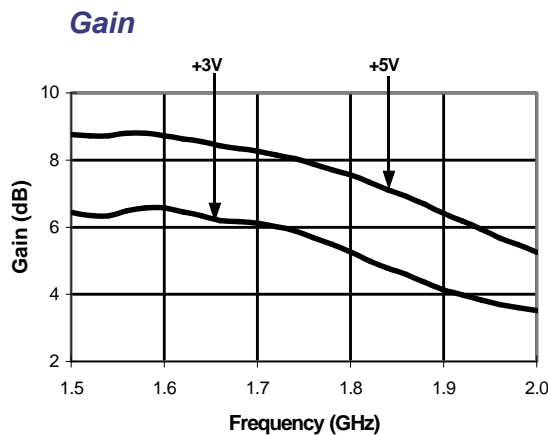

Specifications subject to change without notice.

- North America: Tel. (800) 366-2266
- Asia/Pacific: Tel.+81-44-844-8296, Fax +81-44-844-8298
- Europe: Tel. +44 (1344) 869 595, Fax+44 (1344) 300 020

Visit [www.macom.com](http://www.macom.com) for additional data sheets and product information.



### Typical Performance Curves

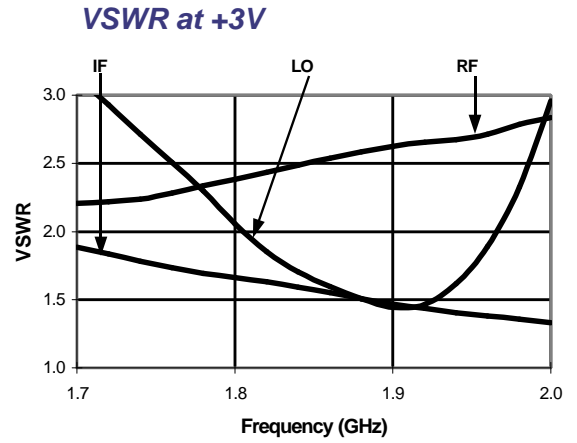
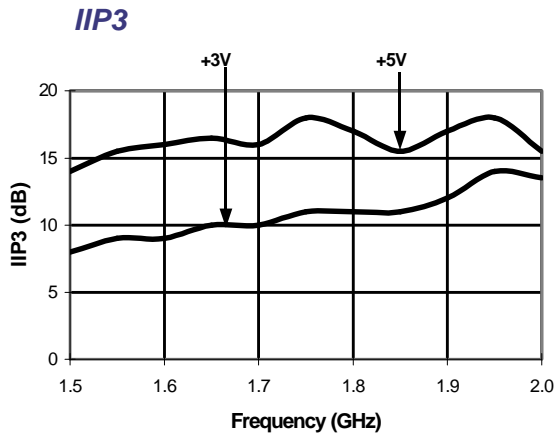

### Ordering Information

| Part Number  | Package                     |
|--------------|-----------------------------|
| SA65-0003    | Bulk Packaging              |
| SA65-0003TR  | Tape and Reel (1K Reel)     |
| SA65-0003-TB | Units Mounted on Test Board |

Specifications subject to change without notice.

- North America: Tel. (800) 366-2266
- Asia/Pacific: Tel.+81-44-844-8296, Fax +81-44-844-8298
- Europe: Tel. +44 (1344) 869 595, Fax+44 (1344) 300 020

Visit [www.macom.com](http://www.macom.com) for additional data sheets and product information.