

TEMPORARY

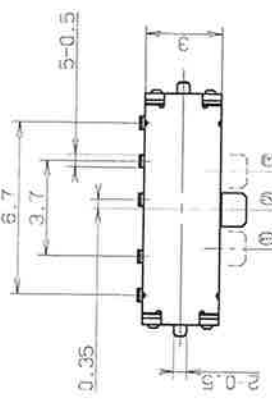

1.5 (Travel) (momentary)
1.5 (Travel) (momentary)

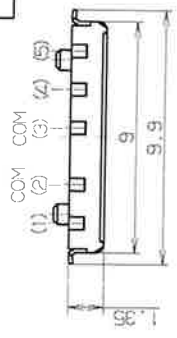
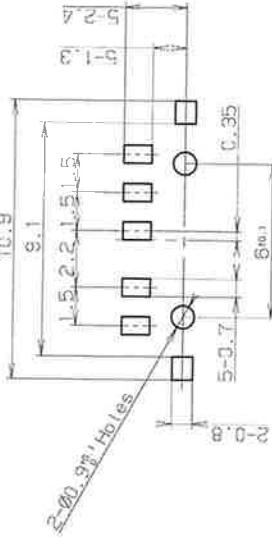
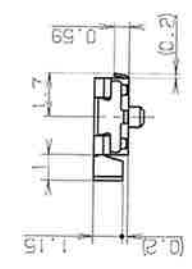
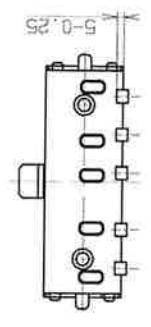
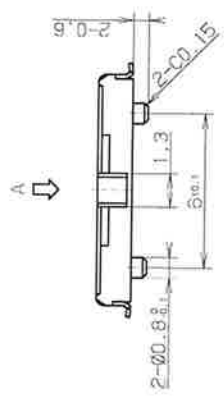

View of A direction
Substrate installation
note reference chart (S=5/1)

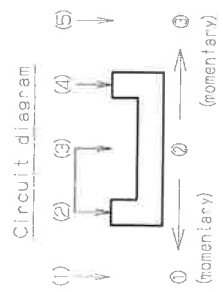

Tolerance

IN	±0.10
IN	±0.03

Axis: Styrene foam
Corrugated cardboard

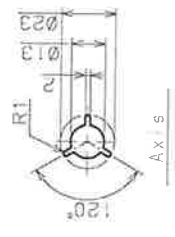
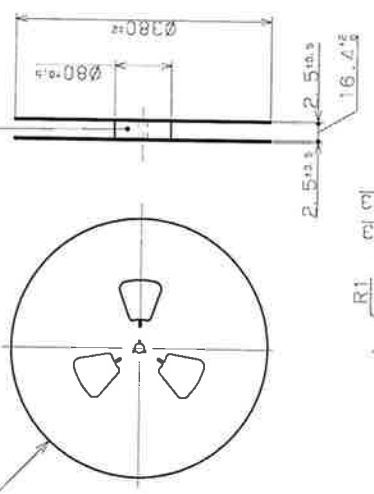

1. See Spec for SLM-755
2. Operating force at root of knob
1.176±0.98N (120±100gf)

NO.	PART NAME	QTY.	REMARKS
8	Cover tape		
7	Carrier tape		
6	Spring	2	S/P or SUS
5	Contact	1	Copper alloy
4	Cover	1	SUS
3	Knob	1	PA
2	Terminal	4	Copper alloy
1	Case	1	PC

CHECKED BY 3RD ANGLE PROJECTION MOR!	CHECKED BY OGAWA
DATE 09.12.29	DATE 09.12.20
DESIGNED BY YANO	DRAWN BY YANO
DATE 09.12.25	DATE 09.12.25
UNITS mm	COMPANY SHIMIZU ELECTRIC CO., LTD.

SLIDE SWITCH

MODEL NO. SLM-13-755-T50
DRAWING NO.
DATE
SCALE

参考図面



図 1 (1) (2) (3) (4) (5)
 操作性 (ツマミ移動部)
 ○開モーターリ、●閉モーターリ



テープ引出し方向

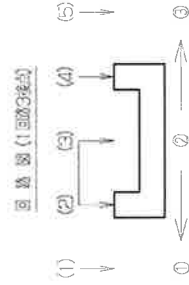
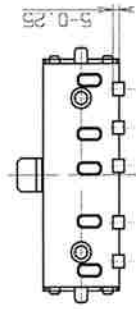
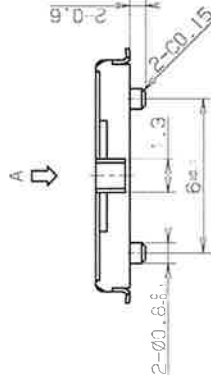
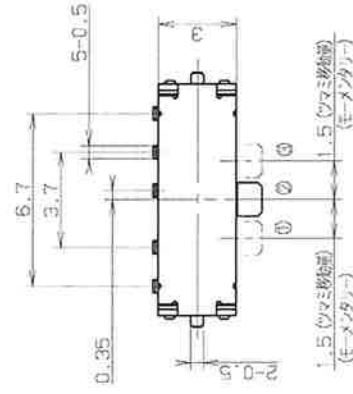
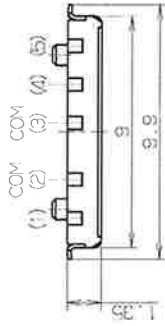
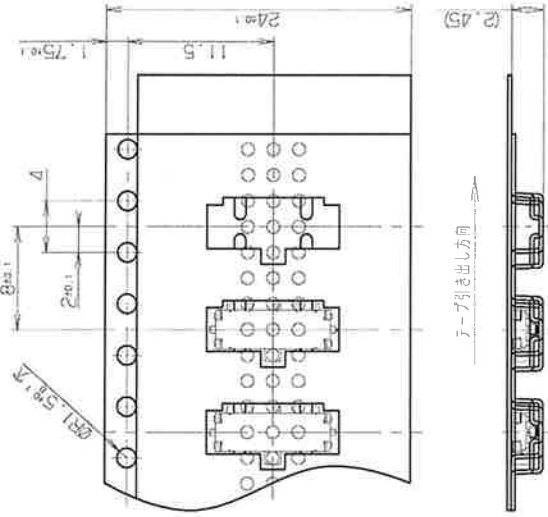
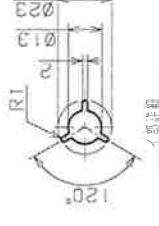

三角図法 単位mm

公差	S10 I10 P2
TOK	S10 I10 P2

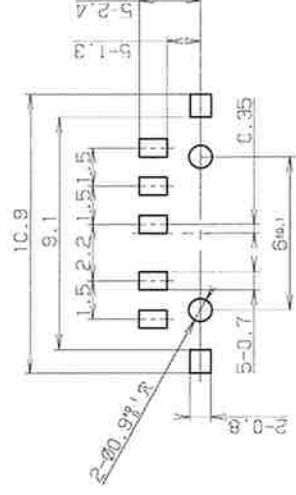
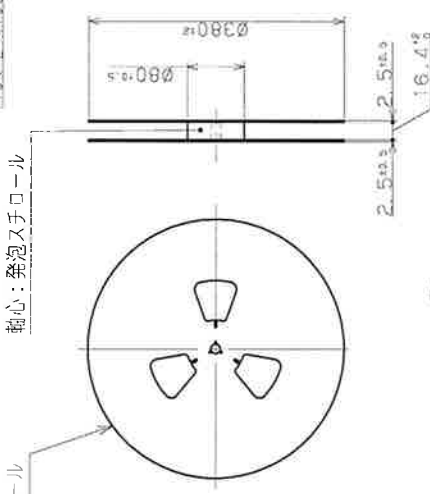

注1. 仕様はSLM-755製品仕様書による。
 注2. 作動力はツマミ型元にて測定し
 1.176±0.06N (120±100gf) のこと

NO.	PART NAME	VOL.	REMARKS
8	カバー		
7	キャリッジ		
6	コイル	2	SWP or SUS
5	弾子	1	鋼鉄
4	カバー	1	SUS
3	調整	1	PA
2	異子	4	鋼鉄
1	ケース	1	LCP

製法	MODEL NO.	スライド スイッチ
図番	DRAWING NO.	SLM-13-755-T50 (X)

製法	CHECKED BY	小川
3RD ANGLE PROJECTION	DESIGNED BY	大井
製法	DRAWN BY	大井
SCALE	DATE	09.09.01
5/1		
UNIT		
m		
SHINWEI ELECTRIC CO., LTD.		



<div style="text-align: center;"> <h1>SLIDE SWITCH SPECIFICATIONS</h1> </div>			APPROVED BY	CHECKED BY	DESIGNED BY
					
SPEC No.	SLM-755	DATE: DECEMBER 25, 2009 ENGINEERING DEPARTMENT MAKING	Page1/2		

Table 1. Rating and initial performance

Item	Standard
The maximum rating	0.3A 4VDC (Resistance load)
The number of circuits	1C-3P
Change timing	Non-specified
Operating temperature range	-10~+60°C
Preservation temperature range	-25~+70°C

TEMPORARY

Mechanical performance

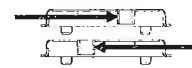
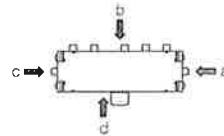
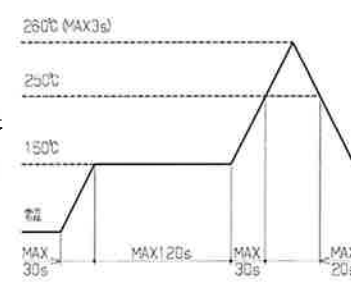
Item	A condition and a measuring method	Standard
Travel		1.5mm
Operating force	It measures at the knob root.	1.176±0.98N(120±100gf)
Knob strength	<p>A static load of 5N (0.51kgf) shall be applied to the nearest point of the component of the knob for 15sec in direction parallel to operation. Measurement of knob strength is performed after soldering to a substrate.</p> 	Without damage of knob. Operation force and electrical characteristics shall be satisfied.
Displacement of knob	A static load of 1N(102gf) shall be applied to the top of the knob and then displacement shall be measured to the direction of the operation.	1mm P-P or less
Insulated board fixed strength	<p>A switch is soldered with hand solder or reflow solder. The load of 20N (2.04kgf) is added in a, b, and the direction of c for 10 seconds. The load of 10N (1.02kgf) is added in the direction of d for 10 seconds. However, about the direction of d, load is added to portions other than an operation part.</p> 	Satisfy an electric performance. There needs to be no remarkable change in appearance.
Terminal strength	<p>A static load shall be applied to the tip of the terminals for 10s in any direction. 1 cycle shall be made per terminal. However, a bend of the terminal at this time is accepted. Pull force: 1N, Pushing force: 0.25N, Bend force: 1.25N It is based on JIS C60068-2-21.</p>	Electrical characteristics shall be satisfied. Without excessive looseness of terminals.
Solderability	It is immersed in (flux Let rosin (JIS K 5902) methanol (JIS K 1501) solution and concentration be 25% of weight ratio abbreviation for) about 5~10 seconds, and is immersed in the soldering part of a terminal for 3±0.5 seconds to a 230±5°C solder tub(Solder is H63A of JIS Z 3282).	A new uniform coating of solder shall cover a minimum of 90% of the surface being immersed. (The fracture side of a terminal part is not applied.)
Resistance to soldering haet	<p>A heating part is a tunnel furnace with up heating. Let temperature be substrate surface temperature. Let a substrate be a glass epoxy copper laminating board (t0.5). After 2 times passing through the reflow furnace of the account profile of the right, it measures after 24-hour neglect in normal temperature and humidity. However, since it cools to 1st after an examination normal temperature, the 2nd examination is carried out. The case of hand solder Solder capacity : 15W Diameter of the solder point: φ 1mm Solder point temperature: 350±10°C Soldering time: 3(+1/0) or less seconds</p> 	Satisfy an electric performance. There needs to be no remarkable change in appearance.

Electrical performance

Item	Condition	Specifications
Contact resistance	It measures it by the fall-of-potential method of DC.5V0.1A. Or, it measures it with the contact Ω meter of 1kHz (20mV.50mA or less).	200mΩ or less
Insulation resistance	A voltage of 100VDC shall be applied for 1min after which measurement shall be made.	100MΩ or more
Withstanding Voltage	100VAC for 1min. Trip current: 2mA. Measuring frequency : 50~60kHz. Between terminal and Between individual terminals and frame.	Without damage to parts arcing or breakdown, etc.

SPEC No.	SLM-755	SLIDE SWITCH SPECIFICATIONS	Page2/2
----------	---------	-----------------------------	---------

Table 2. Life examination and special examination

Item	Test condition and test method	Specifications
Endurance	A switch shall be subjected to 10,000 cycles at a speed of 15 to 20 cycles per min without load. It is based on JIS C5441.	Satisfy table 3
Humidity	Measured within half hour after keeping the switch in a constant temperature constant humidity oven at $40\pm 2^{\circ}\text{C}$, and 90 to 95% relative humidity for 96 hours, followed by leaving it at constant temperature and constant humidity for 1 hour. It is based on JIS C60068-2-3.	Satisfy table 3
Dry heat	Measured within half hour after keeping the switch in a thermostat at $70\pm 2^{\circ}\text{C}$ for 48 hours, followed by leaving it at ambient humidity for 1 hour. It is based on JIS C60068-2-2.	Satisfy table 3
Cold	within half hour after keeping the switch in a thermostat at $-25\pm 3^{\circ}\text{C}$ for 48 hours, followed by leaving it at ambient humidity for 1 hour. It is based on JIS C60068-2-1.	Satisfy table 3

[Explanatory notes] Measured it removes drop of water after humidity, cold examination, and temperature cycle.

Table 3. Standard after life test and special test

Item	Specifications
1 Operation force	Less than $\pm 30\%$ of a standard value.
2 Contact resistance	500m Ω or less
3 Insulation resistance	10M Ω or more
4 Withstanding Voltage	Impression during 100VAC or 1 minute. There are not damage, an arc, and insulated destruction.
5 Appearance	There are not modification and a crack in a forming portion.

Table 4. Notes

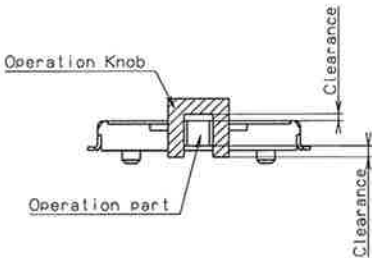
- Since this article is not waterproofing structure, please do not perform washing.
 - Especially, since it is thin, please consider this switch for power not to join an operation part from the upper and lower sides (perpendicular). Please prepare and make clearance into a vertical portion to an operation part as shown in the right figure about the operation knob of a set.
Moreover, please consider the stopper structure in a case for on-the-strength protection of an operation part and a switch main part.
- 
- Since the characteristic may change with the curvature of a substrate, please take into consideration enough about a pattern design and a layout.
 - As there is the case that a part of the terminal exposes at the side of PC board mounting, consideration should be given to the pattern design and layout.
 - Please consider for the power beyond a standard not to join an operation part. Please do not let flux adhere to a resin part.
 - I need your help so that power may not be applied to a terminal part and an operation part in the state of a switch single article before substrate mounting (before soldering).
 - Keep in mind that there is fear of modification and other performance degradation according to conditions if power joins a terminal part at the time of soldering.
 - When soldering (preliminary heating), go in the condition which changed an operation part (the lever) surely.
 - Please check on actual mass-production conditions about a setup of reflow conditions.
 - Switches with mechanical contacts have the phenomenon that occurs instantaneous on and off (chattering and bouncing) on contacts during changeover and also the same phenomenon during stationary position by the external factors (shock and vibration), special consideration for contact chattering and bounce shall be necessary when designing digital circuits and software.
 - Since soldering quality may deteriorate due to sulfuration and oxidation of terminals, Use them as soon as possible, within a maximum of 6 months after delivery. Shut it tight to avoid contact with the air, and use it in the storage in the storage condition and the one within 1 week after you unpack it again.
 - For reliability an actual test should be done.