

**GaAs Broadband 75 Ohm Default-On, SPDT Terminated Switch
DC - 2.5 GHz**

**MASWSS0201
V1**

Features

- Ideal for CATV, DTV, DVR, STB Applications
- Default-On in Unpowered State (RFC-RF1 Path)
- Broadband Performance: DC-2.5 GHz
- Low Insertion Loss: 1.1 dB at 1 GHz
- High Isolation: > 60dB @ 100MHz
- Single Control Operation
- Power Handling: > 20 dBm P1dB
- Lead-Free 3 mm 12-lead PQFN Package
- 100% Matte Tin Plating over Copper
- Halogen-Free "Green" Mold Compound
- RoHS* Compliant and 260°C Reflow Compatible
- Configurable for Non-terminated Operation

Description

M/A-COM's MASWSS0201 is a broadband GaAs PHEMT MMIC SPDT terminated switch in a low cost, lead-free 3 mm 12-lead PQFN package. The MASWSS0201 is ideally suited for applications where an unpowered on state is critical in a single control line SPDT terminated switch. The unpowered condition is the same as the $V_C = 0$ condition. This part can also be configured as a reflective switch with minimal impact to the RF performance.

The MASWSS0201 delivers high isolation, low insertion loss and high linearity up to 2.5 GHz.

The MASWSS0201 is fabricated using a 0.5 micron gate length GaAs E/D PHEMT process. The process features full passivation for performance and reliability.

Ordering Information ¹

Part Number	Package
MASWSS0201TR-3000	3000 piece reel
MASWSS0201SMB	Sample Test Board (Includes 5 Samples)

1. Reference Application Note M513 for reel size information.

Functional Schematic

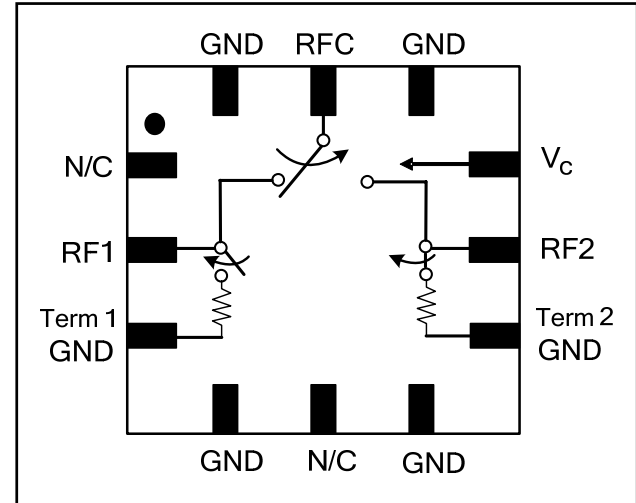

Pin Configuration ²

Pin No.	Pin Name	Description
1	N/C	No Connection
2	RF1	RF Port 1
3	Term 1 GND ³	Termination 1 Ground
4	GND	Ground
5	N/C	No Connection
6	GND	Ground
7	Term 2 GND ³	Termination 2 Ground
8	RF2	RF Port 2
9	VC	Control
10	GND	Ground
11	RFC	RF Input
12	GND	Ground
13	Paddle ⁴	RF and DC Ground

2. M/A-COM recommends that all unused (N/C) pins be connected to ground. All data on this datasheet was taken with N/C pins connected to ground.
3. Terminated grounds require DC blocking capacitors; see application schematic.
4. The exposed pad centered on the package bottom must be connected to RF and DC ground.

* Restrictions on Hazardous Substances, European Union Directive 2002/95/EC.

**GaAs Broadband 75 Ohm Default-On, SPDT Terminated Switch
DC - 2.5 GHz**

**MASWSS0201
V1**

Electrical Specifications: $T_A = 25^\circ\text{C}$, $Z_0 = 75 \Omega$, $V_C = 0 \text{ V}/3 \text{ V}$, $P_{IN} = 0 \text{ dBm}$ ⁵

Parameter	Test Conditions	Units	Min.	Typ.	Max.
Insertion Loss RFC to RF1 ($V_C = 0\text{V}$)	100 MHz	dB	—	0.9	1.75
	1.0 GHz	dB	—	1.0	1.85
	2.0 GHz	dB	—	1.3	—
Insertion Loss RFC to RF2 ($V_C = 3\text{V}$)	100 MHz	dB	—	1.0	1.65
	1.0 GHz	dB	—	1.2	1.85
	2.0 GHz	dB	—	1.5	—
Isolation	100 MHz	dB	60	65	—
	1.0 GHz	dB	40	45	—
	2.0 GHz (RFC - RF1)	dB	—	38	—
	2.0 GHz (RFC - RF2)	dB	—	43	—
Return Loss	DC - 2.0 GHz	dB	—	25	—
IIP2 ($V_C = 0\text{V} / 3\text{V} / 5\text{V}$)	Two Tone, +5 dBm/Tone, 10 MHz Spacing	dBm	—	54 / 51 / 53	—
	100 MHz				
IIP3 ($V_C = 0\text{V} / 3\text{V} / 5\text{V}$)	Two Tone, +5 dBm/Tone, 10 MHz Spacing	dBm	—	38 / 38 / 39	—
	100 MHz				
Input P1dB ($V_C = 0\text{V} / 3\text{V} / 5\text{V}$)	100 MHz	dBm	—	21 / 21 / 22	—
	1.0 GHz				
T-rise T-fall	10% to 90% RF	μS nS	—	1.4	—
	90% to 10% RF				
Ton Toff	50% control to 90% RF	μS nS	—	1.6	—
	50% control to 10% RF				
Transients	—	mV	—	550	—
Control Current	$V_C = 3\text{V}$	μA	—	250	500

5. Electrical specifications apply to terminated configuration only.

Absolute Maximum Ratings ^{6,7}

Parameter	Absolute Maximum
Input Power @ 100 MHz	+22 dBm
Input Power @ 1 GHz	+29 dBm
Operating Voltage	+8.5 volts
Operating Temperature	-40°C to +85°C
Storage Temperature	-65°C to +150°C

6. Exceeding any one or combination of these limits may cause permanent damage to this device.
7. M/A-COM does not recommend sustained operation near these survivability limits.

Truth Table ^{8,9,10}

Control V_C	RFC-RF1	RFC-RF2
0	On	Off
1	Off	On

8. External DC blocking capacitors are required on all RF ports.
9. 0 = 0 ± 0.1 V, 1 = +2.9 V to +5 V.
10. The unpowered on state is the same as $V_C=0$.

**GaAs Broadband 75 Ohm Default-On, SPDT Terminated Switch
DC - 2.5 GHz**

**MASWSS0201
V1**

Typical Performance Curves: $T_A = 25^\circ\text{C}$, $Z_0 = 75 \Omega$, Components per Application Schematic

Insertion Loss

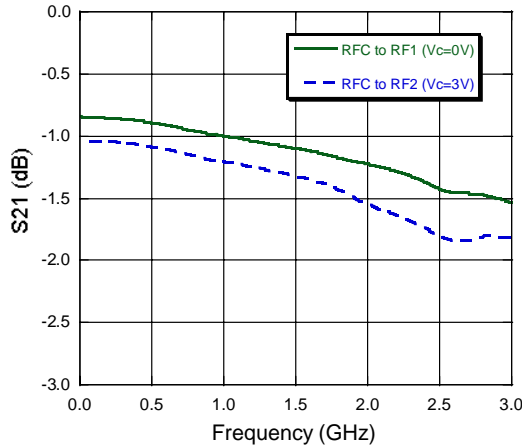

RF1 Return Loss

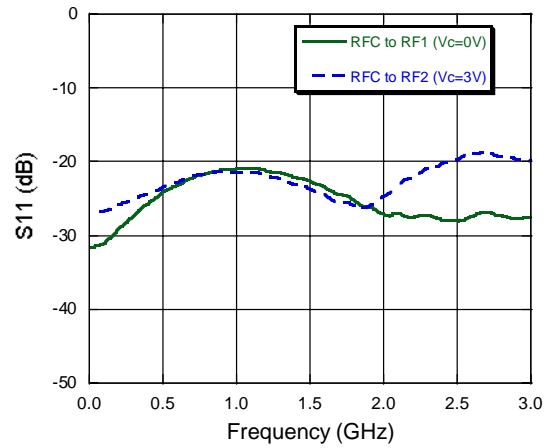

Isolation (Below 200 MHz)

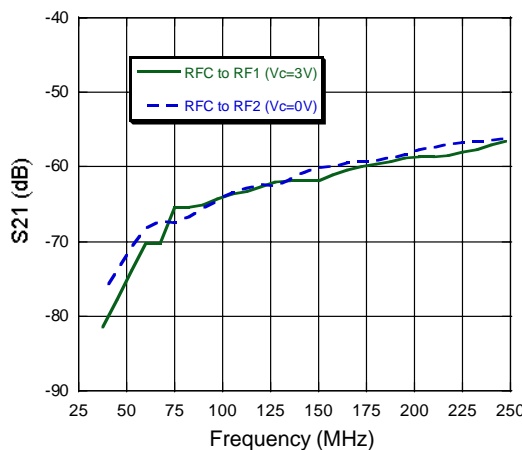

RF1 Return Loss

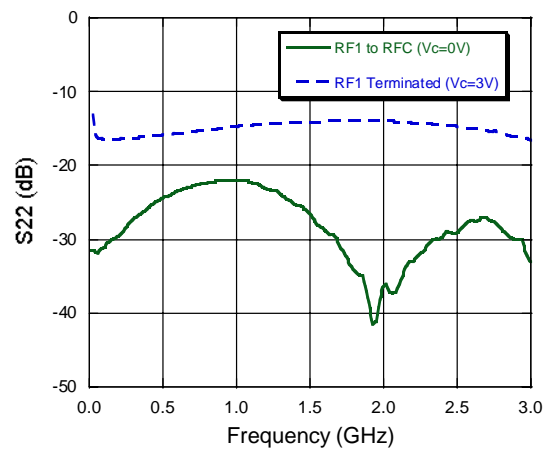

Isolation (Above 200 MHz)

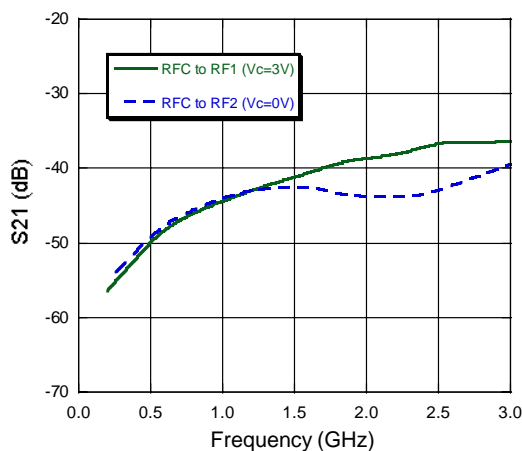

RF2 Return Loss

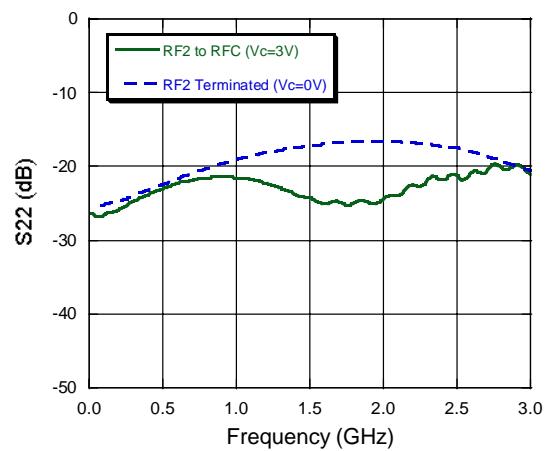

**GaAs Broadband 75 Ohm Default-On, SPDT Terminated Switch
DC - 2.5 GHz**

**MASWSS0201
V1**

Lead-Free 3 mm 12-lead PQFN†

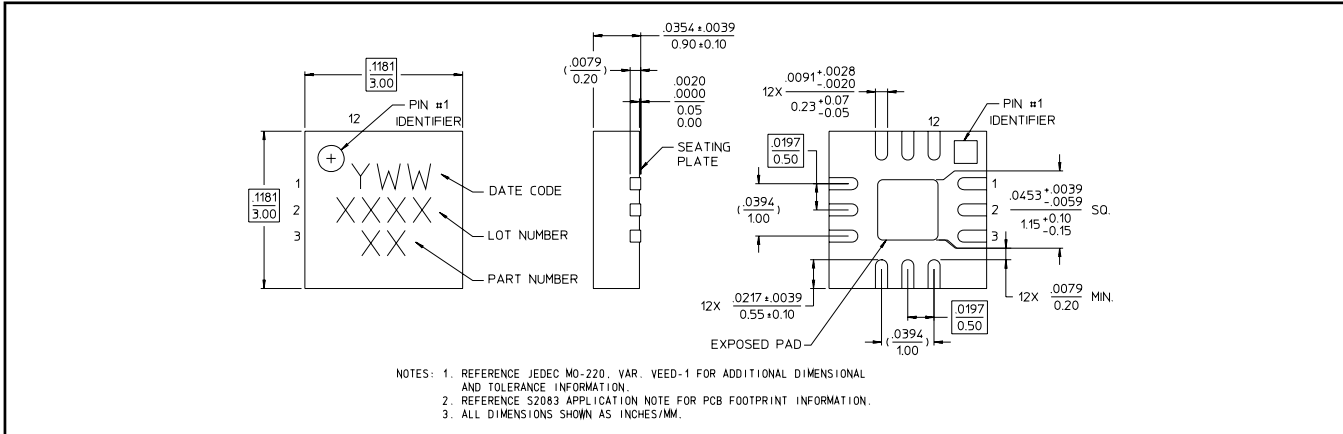

† Reference Application Note M538 for lead-free solder reflow recommendations.
Meets JEDEC moisture sensitivity level 1 requirements.

Application Schematic ^{11,12}

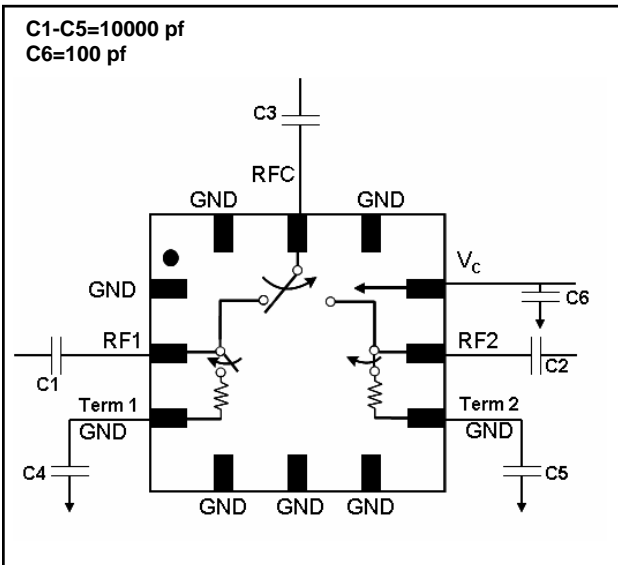

11. Non-connected pins (P1 and P5) are shown connected to ground as recommended. All data on this datasheet was taken with N/C pins connected to ground.
12. Application schematic shown is for terminated configuration. For non-terminated operation Term 1 and Term 2 ground pins are left open. See application section for data in unterminated configuration.

Qualification

Qualified to M/A-COM specification REL-201, Process Flow -2.

Handling Procedures

Please observe the following precautions to avoid damage:

Static Sensitivity

Gallium Arsenide Integrated Circuits are sensitive to electrostatic discharge (ESD) and can be damaged by static electricity. Proper ESD control techniques should be used when handling these devices.

M/A-COM's AN3007 Application Note outlines a method for ESD sensitivity mitigation. It can be found at the Tech/Apps section of the MACOM.COM website.

Application Section

Typical Performance Curves:

$T_A = 25^\circ\text{C}$, $Z_0 = 75 \Omega$, Underterminated Configuration (Term 1&2 GND pins open)

Insertion Loss

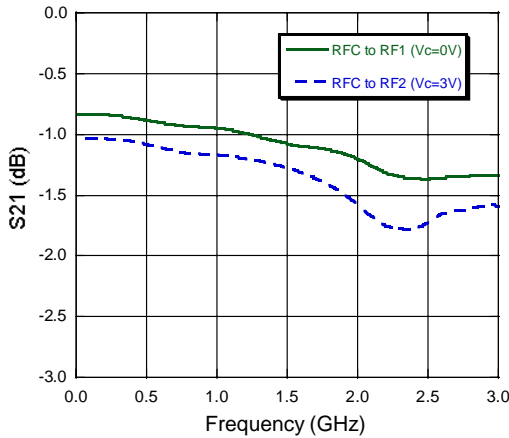

RFC Return Loss

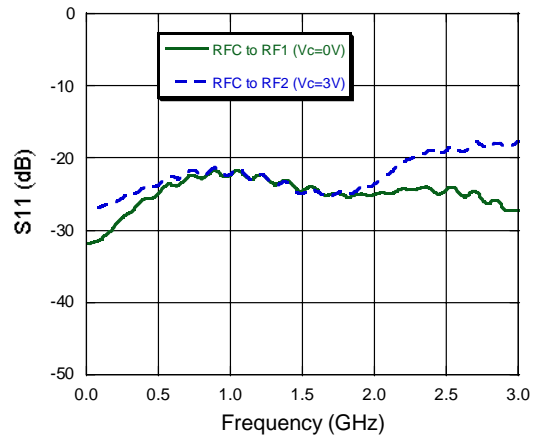

Isolation (Below 200 MHz)

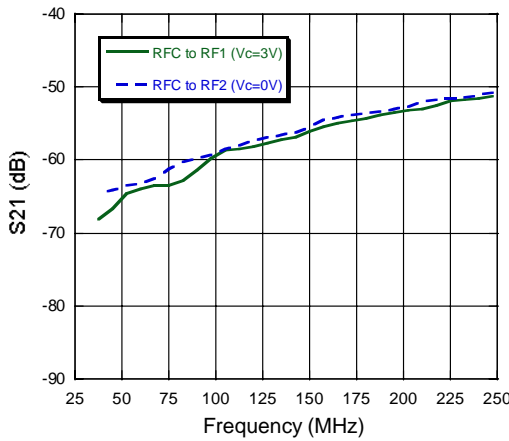

RF1 Return Loss

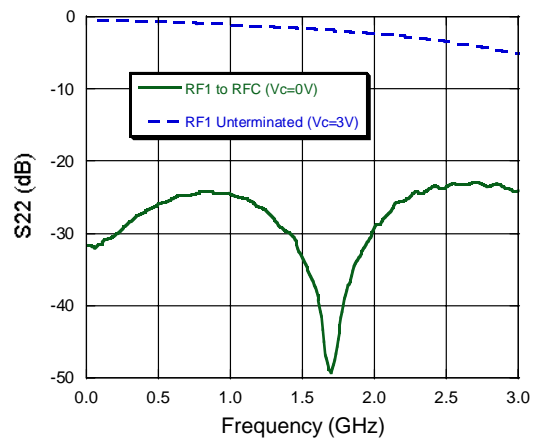

Isolation (Above 200 MHz)

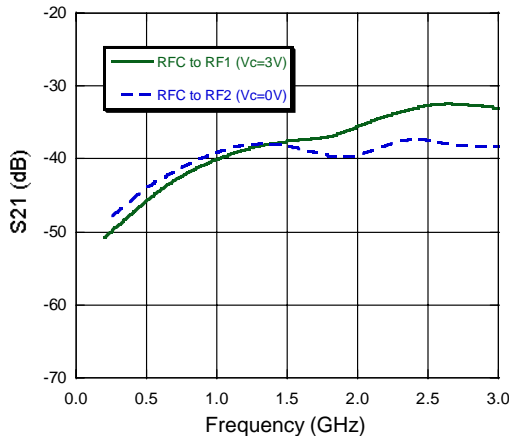

RF2 Return Loss

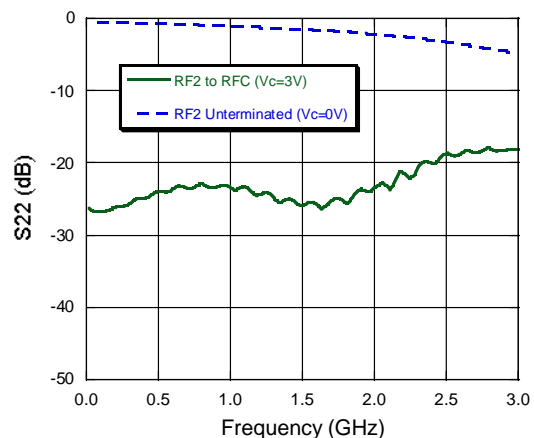

Application Section

**Application Schematic –
Unterminated Configuration**

