

**PLEASE CHECK WWW.MOLEX.COM FOR LATEST PART INFORMATION**

**Part Number:** [0355720800](#)  
**Status:** **Active**  
**Description:** 2.50mm (.098") Pitch Wire-to-Wire and Wire-to-Board Housing, Positive Lock, Nylon 6/6 Material, 8 Circuits, Natural

**Documents:**

[Drawing \(PDF\)](#) [RoHS Certificate of Compliance \(PDF\)](#)  
[Product Specification PS-35572-001 \(PDF\)](#)

**General**

Product Family	Crimp Housings
Series	<a href="#">35572</a>
Product Name	N/A

**Physical**

Breakaway	No
Circuits (maximum)	8
Color - Resin	Natural
Gender	Female
Glow-Wire Compliant	No
Keying to Mating Part	None
Lock to Mating Part	Yes
Material - Resin	Polyester
Number of Rows	1
Packaging Type	Bag
Panel Mount	No
Pitch - Mating Interface (in)	0.098 In
Pitch - Mating Interface (mm)	2.50 mm
Temperature Range - Operating	-40°C to +105°C

**Material Info**

**Reference - Drawing Numbers**

Product Specification	PS-35572-001
Sales Drawing	SD-35572-001

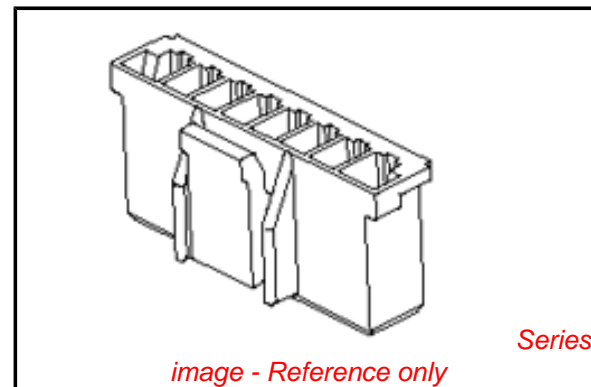

**EU RoHS**

**ELV and RoHS Compliant**  
**REACH SVHC Contains SVHC: No**  
**Halogen-Free Status**

**China RoHS**



**Need more information on product environmental compliance?**

Email [productcompliance@molex.com](mailto:productcompliance@molex.com)  
 For a multiple part number RoHS Certificate of Compliance, [click here](#)

Please visit the [Contact Us](#) section for any non-product compliance questions.

**Search Parts in this Series**

[35572Series](#)

**Mates With**

[35312](#) Vertical Shrouded Header, [35184](#) Plug Housing

**Use With**

[57915](#) Wire-to-Board Terminal

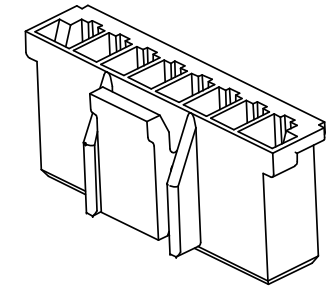
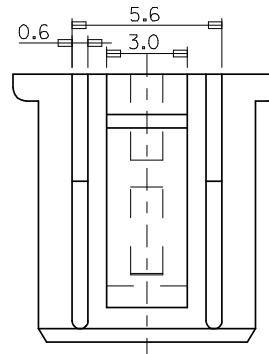
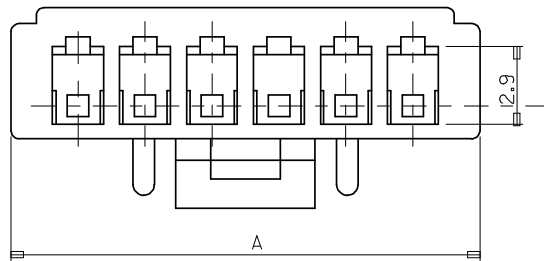

3 CKT ONLY

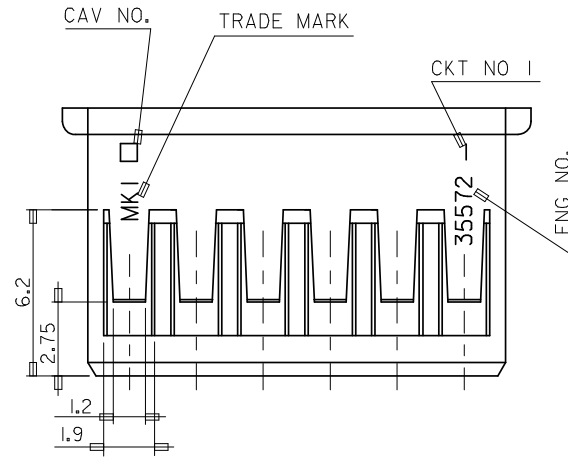
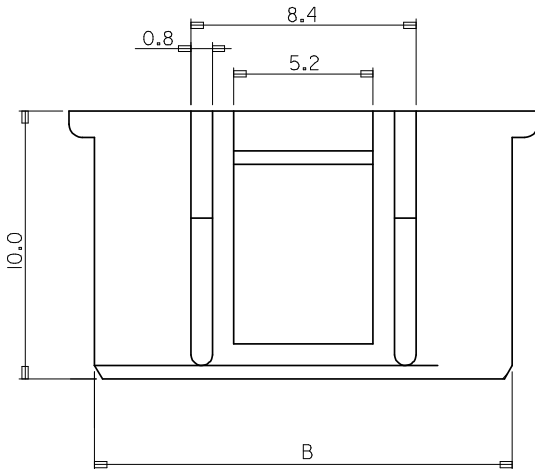
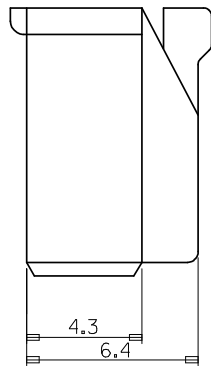

NOTE

1. MATERIAL : PBT UL94V-0 (VALOX 3IOSE0)
2. COLOR : 0 : NATURAL  
2 : RED (ONLY 4P,6P,10P)
3. USED TERMINAL : 57915-9002/8001
4. MATED : 35312/35184

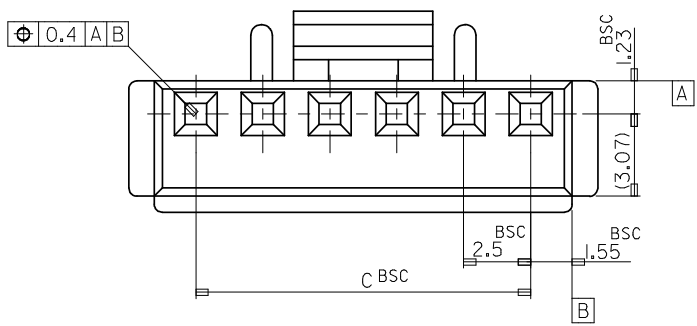

					20.0	23.1	25.0	35572-0900	9
35.0	38.1	40.0	35572-1500	15	17.5	20.6	22.5	35572-0800	8
32.5	35.6	37.5	35572-1400	14	15.0	18.1	20.0	35572-0700	7
30.0	33.1	35.0	35572-1300	13	12.5	15.6	17.5	35572-060*	6
27.5	30.6	32.5	35572-1200	12	10.0	13.1	15.0	35572-0500	5
25.0	28.1	30.0	35572-1100	11	7.5	10.6	12.5	35572-040*	4
22.5	25.6	27.5	35572-100*	10	5.0	8.1	10.0	35572-0300	3
C	B	A	ENG NO.	CKT	C	B	A	ENG NO.	CKT

<b>REVISED</b> EC NO: KOR2008-0109 DRWN: JHPARK01 2008/01/02 CHKD: WY. YANG 2008/01/02 APPR: YUNS IKK IM 2008/01/02	QUALITY SYMBOLS ▽=0 ▽=0	GENERAL TOLERANCES (UNLESS SPECIFIED) <table border="1"> <tr> <th></th> <th>mm</th> <th>INCH</th> </tr> <tr> <td>4 PLACES</td> <td>± ---</td> <td>± ---</td> </tr> <tr> <td>3 PLACES</td> <td>± ---</td> <td>± ---</td> </tr> <tr> <td>2 PLACES</td> <td>± ---</td> <td>± ---</td> </tr> <tr> <td>1 PLACE</td> <td>± 0.2</td> <td>± ---</td> </tr> </table>		mm	INCH	4 PLACES	± ---	± ---	3 PLACES	± ---	± ---	2 PLACES	± ---	± ---	1 PLACE	± 0.2	± ---	DIMENSION STYLE <b>MM ONLY</b>	SCALE <b>5:1</b>	DESIGN UNITS <b>METRIC</b>	THIRD ANGLE PROJECTION
		mm	INCH																		
	4 PLACES	± ---	± ---																		
	3 PLACES	± ---	± ---																		
2 PLACES	± ---	± ---																			
1 PLACE	± 0.2	± ---																			
DRAFT WHERE APPLICABLE MUST REMAIN WITHIN DIMENSIONS	DRAWN BY HS. SHIN	DATE 2000/02/17	<b>2.5 PITCH W/B CONN HOUSING</b>																		
MATERIAL NO. <b>SD35572.DGN</b>	CHECKED BY JK. OH	DATE 2000/02/17	<b>MOLEX INCORPORATED</b>																		
SIZE <b>A3</b>	APPROVED BY CW. LEE	DATE 2000/02/17	DOCUMENT NO. <b>SD-35572-001</b>	SHEET NO. <b>1 OF 01</b>	THIS DRAWING CONTAINS INFORMATION THAT IS PROPRIETARY TO MOLEX INCORPORATED AND SHOULD NOT BE USED WITHOUT WRITTEN PERMISSION																