

2ch LOW DROPOUT VOLTAGE REGULATOR

■ GENERAL DESCRIPTION

The NJM2892 is a 2ch low dropout voltage regulator with ON/OFF control.

Advanced Bipolar technology achieves low noise, high ripple rejection and low quiescent current.

■ PACKAGE OUTLINE



NJM2892F1

■ FEATURES

- High Ripple Rejection 75dB typ. (f=1kHz $V_o=3V$ version)
- Output Noise Voltage $V_{NO}=45\mu V_{rms}$ typ.
- Output capacitor with 1.0 μF ceramic capacitor ($V_o\geq 2.7V$)
- Output Current $I_o(max.)=100mA \times 2ch$
- High Precision Output $V_o\pm 1.0\%$
- Low Dropout Voltage 0.1V typ. ($I_o=60mA$)
- ON/OFF Control
- Internal Short Circuit Current Limit
- Internal Thermal Overload Protection
- Bipolar Technology
- Package Outline SOT-23-6 (MTP-6 : 2.8x2.9x1.1mm)

■ PIN CONFIGURATION

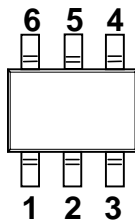

NJM2892F1

PIN FUNCTION

1. V_{OUT2}
2. GND
3. V_{OUT1}
4. CONTROL1
5. V_{IN}
6. CONTROL2

NJM2892

■ EQUIVALENT CIRCUIT

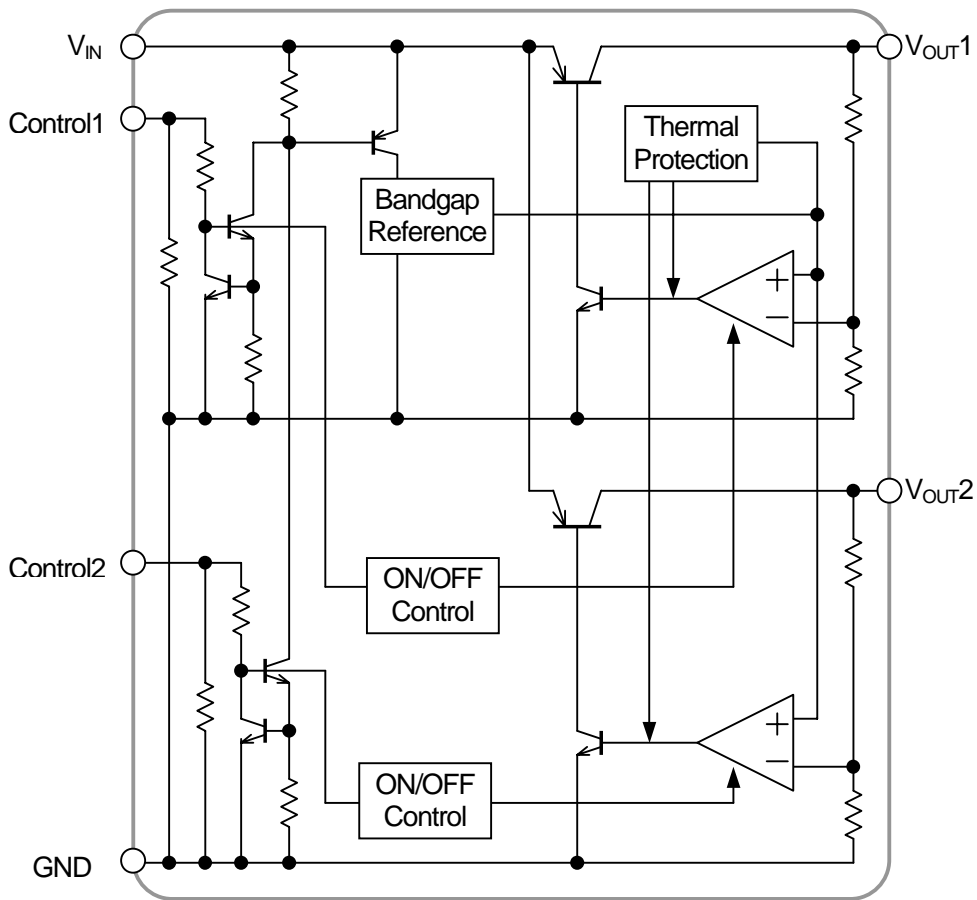

NJM2892

■ OUTPUT VOLTAGE RANK LIST (* : Under development)

Device Name	V _{OUT}	
	Ch 1	Ch 2
*NJM2892F1-1515	1.5V	1.5V
*NJM2892F1-1815	1.8V	1.5V
NJM2892F1-2121	2.1V	2.1V
NJM2892F1-0303	3.0V	3.0V
NJM2892F1-3328	3.3V	2.8V
NJM2892F1-3333	3.3V	3.3V
NJM2892F1-0521	5.0V	2.1V
*NJM2892F1-0533	5.0V	3.3V

■ ABSOLUTE MAXIMUM RATINGS

(Ta=25°C)

PARAMETER	SYMBOL	RATINGS	UNIT
Input Voltage	V _{IN}	+14	V
Control Voltage	V _{CONT}	+14(*1)	V
Power Dissipation	P _D	SOT-23-6 350(*2) 200(*3)	mW
Operating Temperature	Topr	-40 ~ +85	°C
Storage Temperature	Tstg	-40 ~ +125	°C

(*1): When input voltage is less than +14V, the absolute maximum control voltage is equal to the input voltage.

(*2): Mounted on glass epoxy board based on EIA/JEDEC. (114.3x76.2x1.6mm: 2Layers)

(*3): Device itself.

■ Operating voltage

V_{IN}=+2.3 ~ +14V (In case of Vo<2.1V version)

■ ELECTRICAL CHARACTERISTICS

(V_{IN}=Vo+1V, C_{IN}=0.1μF, Co=1.0μF: Vo≥2.7V (Co=2.2μF : 1.8V<Vo≤2.6V., Co=4.7μF : Vo≤1.8V), Ta=25°C)

PARAMETER	SYMBOL	TEST CONDITION	MIN.	TYP.	MAX.	UNIT
Output Voltage	Vo	Io=30mA	-1.0%	-	+1.0%	V
Quiescent Current 1	I _{Q1}	V _{CONT} 1= V _{IN} , V _{CONT} 2= 0V or V _{CONT} 2= V _{IN} , V _{CONT} 1= 0V Io=0mA, Except I _{CONT}	-	150	220	μA
Quiescent Current 2	I _{Q2}	V _{CONT} 1= V _{CONT} 2= V _{IN} Io=0mA, Except I _{CONT}	-	270	400	μA
Quiescent Current at Control OFF	I _{Q(OFF)}	V _{CONT} =0V	-	-	100	nA
Output Current	Io	Vo=0.3V	100	130	-	mA
Line Regulation	ΔVo/ΔV _{IN}	V _{IN} =Vo+1V ~ Vo+6V, Io=30mA	-	-	0.10	%/V
Load Regulation	ΔVo/ΔIo	Io=0 ~ 60mA	-	-	0.03	%/mA
Dropout Voltage(*4)	ΔV _{IO}	Io=60mA	-	0.1	0.18	V
Ripple Rejection	RR	ein=200mVrms, f=1kHz, Io=10mA, Vo=3V version	-	75	-	dB
Average Temperature Coefficient of Output Voltage	ΔVo/ΔTa	Ta=0 ~ 85°C, Io=10mA	-	± 50	-	ppm/°C
Output Noise Voltage	V _{NO}	f=10Hz ~ 80kHz, Io=10mA, Vo=3V version	-	45	-	μVrms
Control Voltage for ON-state	V _{CONT(ON)}		1.6	-	-	V
Control Voltage for OFF-state	V _{CONT(OFF)}		-	-	0.6	V

(*4): The output voltage excludes under 2.1V.

(*5): V_{IN}=Vo+1V means add 1V to higher output voltage.

The above specification is a common specification for all output voltages.

Therefore, it may be different from the individual specification for a specific output voltage.

NJM2892

■ TEST CIRCUIT

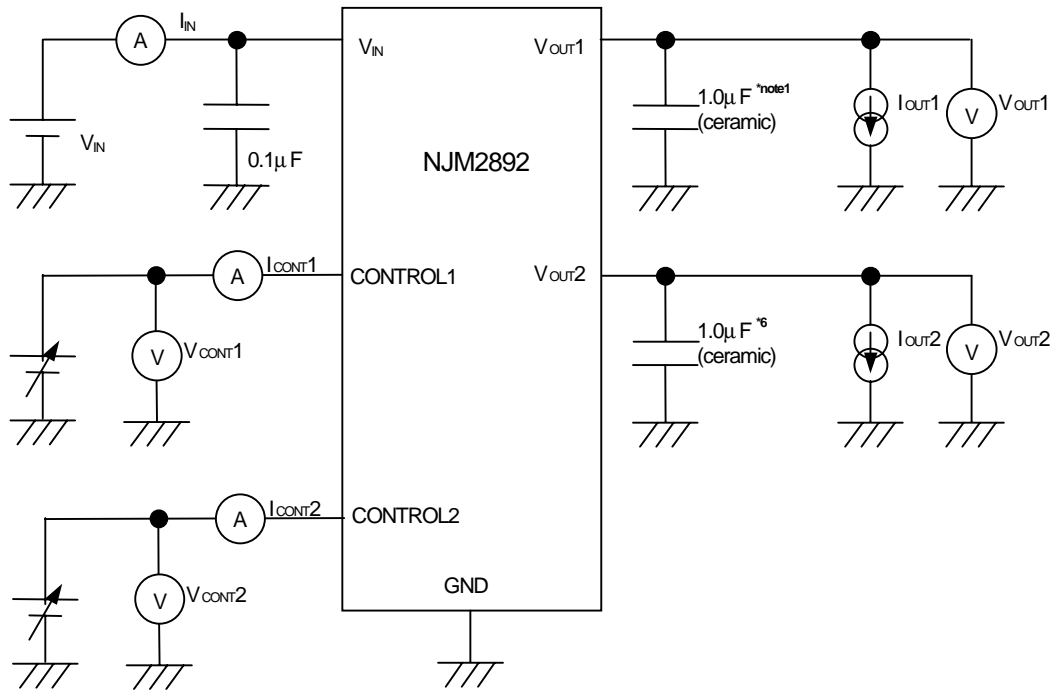

*6 1.8V < V_o ≤ 2.6V version : $C_o = 2.2\mu F$ (ceramic)
 $V_o \leq 1.8V$ version : $C_o = 4.7\mu F$ (ceramic)

■ TYPICAL APPLICATION

① In the case where ON/OFF Control is not required:

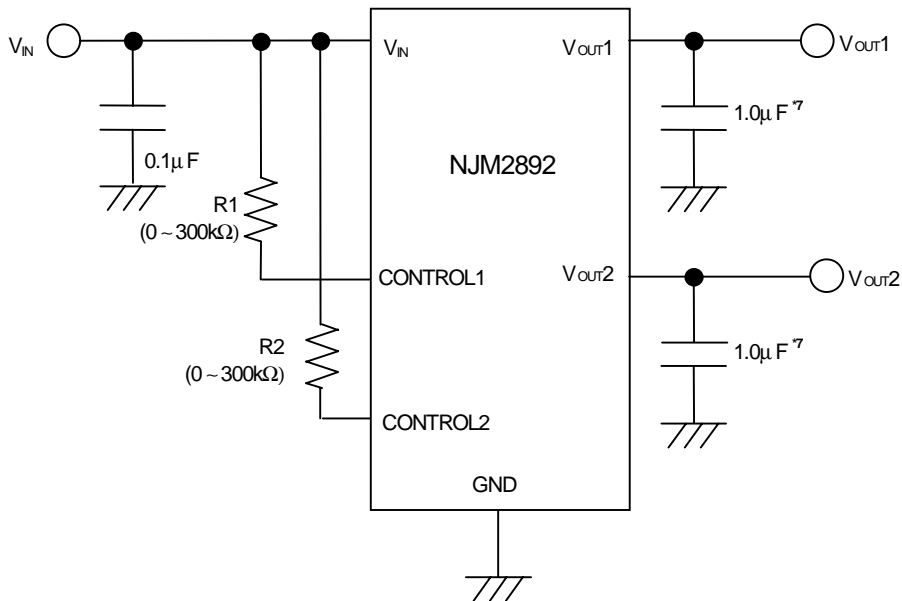

*7 1.8V < V_o ≤ 2.6V version : $C_o=2.2\mu F$
 $V_o \leq 1.8V$ version : $C_o=4.7\mu F$

Connect control terminal to V_{IN} terminal

The quiescent current can be reduced by using a resistance "R". Instead, it increases the minimum operating voltage. For further information, please refer to Figure "Output Voltage vs. Control Voltage".

② In use of ON/OFF CONTROL:

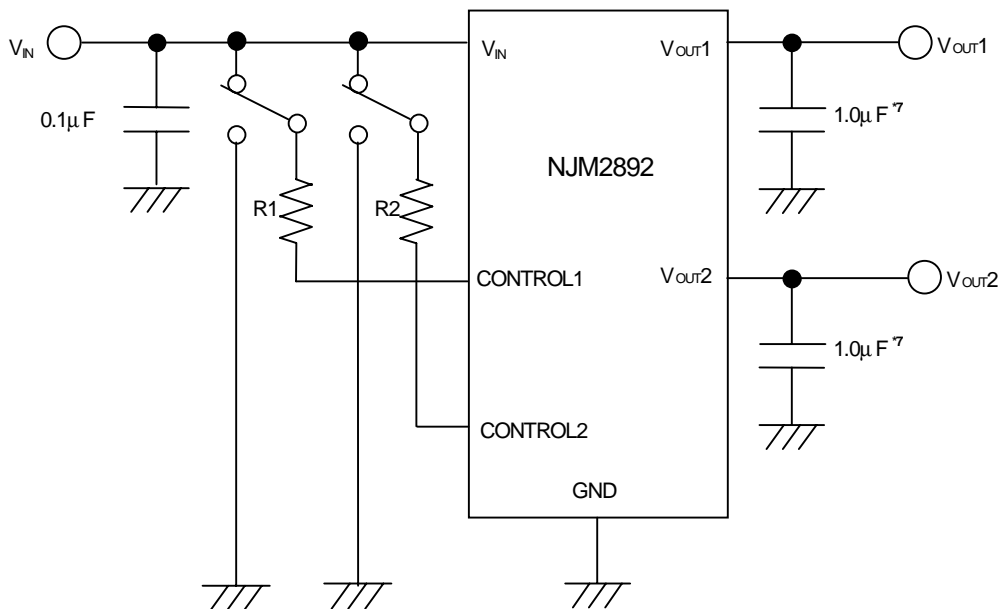

*7 1.8V < V_o ≤ 2.6V version : $C_o=2.2\mu F$
 $V_o \leq 1.8V$ version : $C_o=4.7\mu F$

State of control terminal:

- "H" → output is enabled.
- "L" or "open" → output is disabled.

NJM2892

POWER DISSIPATION vs. AMBIENT TEMPERATURE

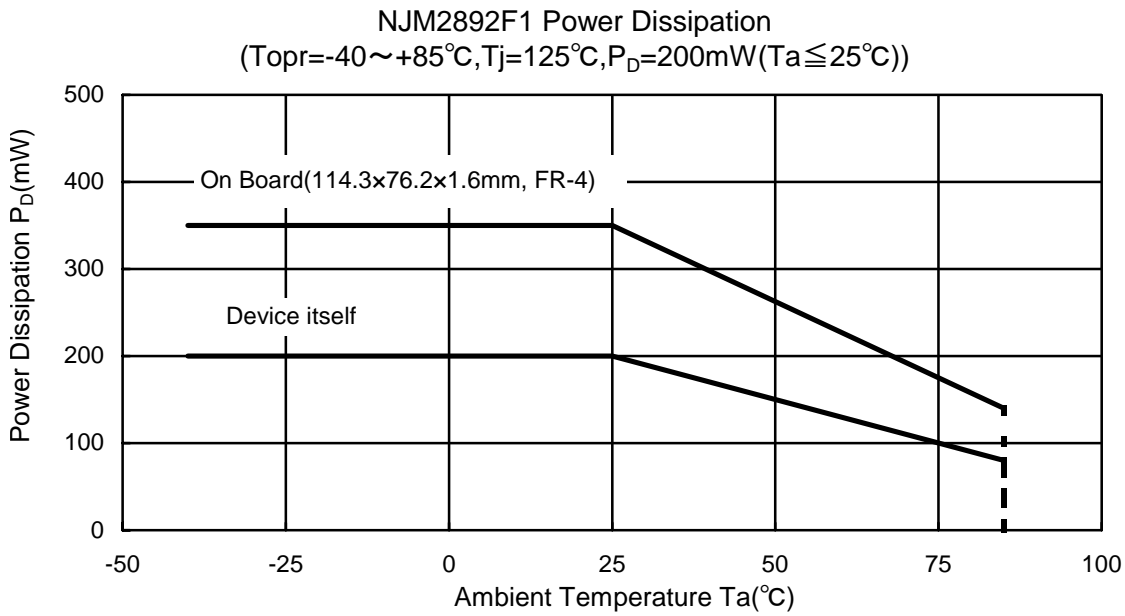

ELECTRICAL CHARACTERISTICS

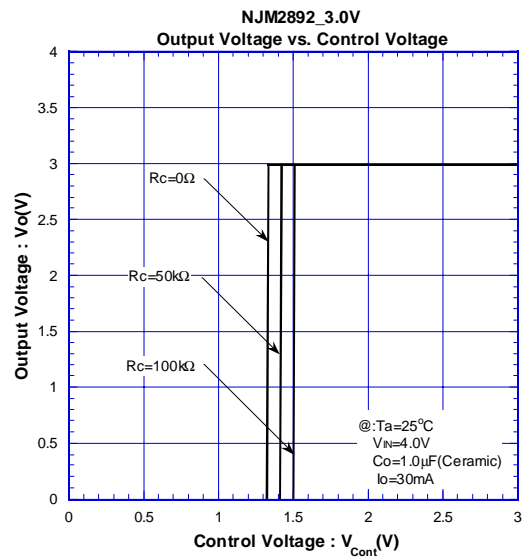
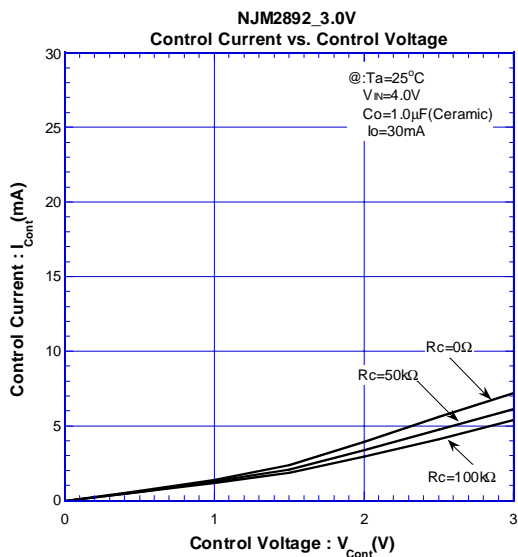
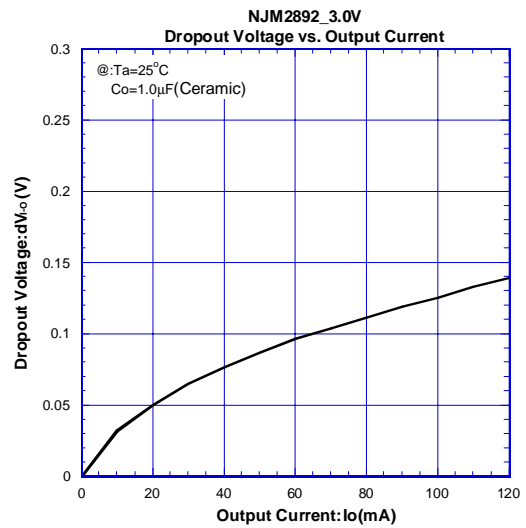
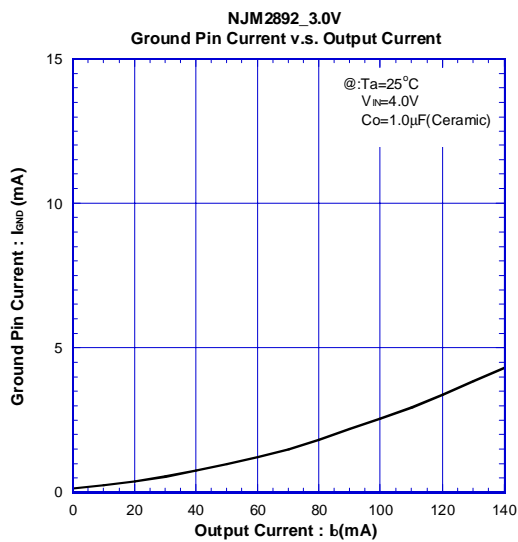
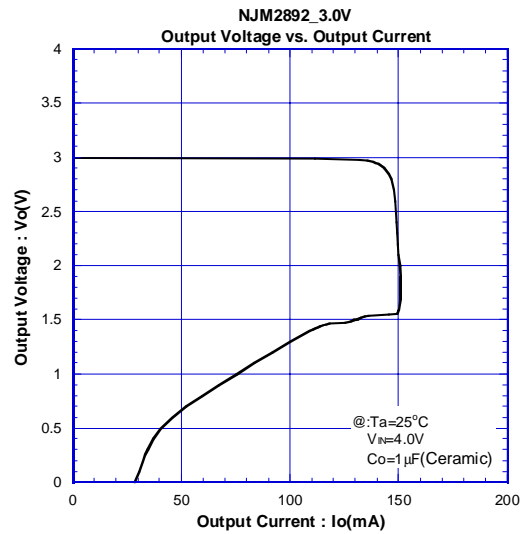
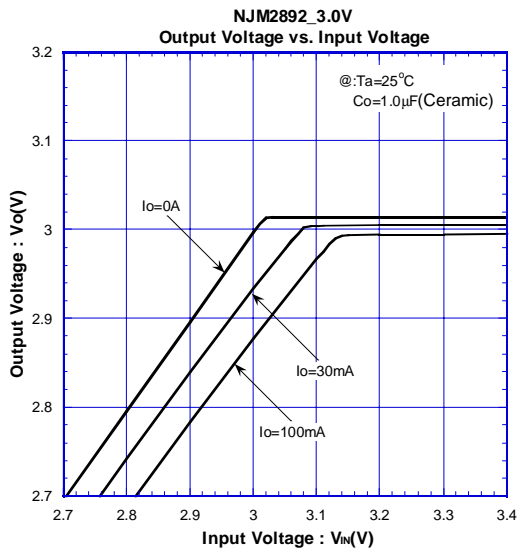

NJM2892

■ ELECTRICAL CHARACTERISTICS

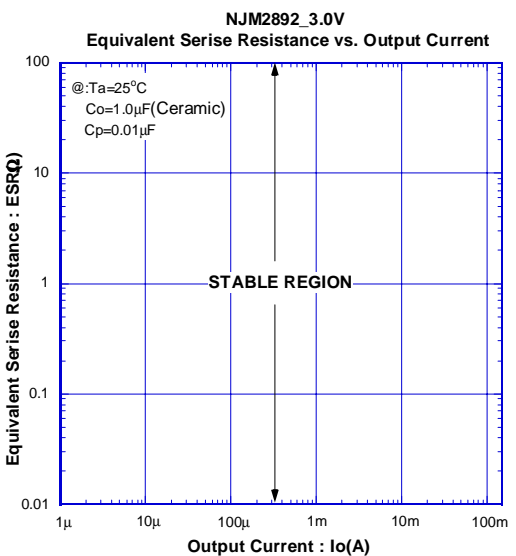
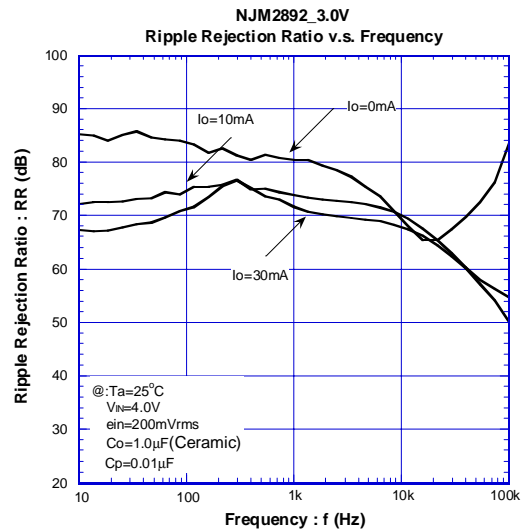
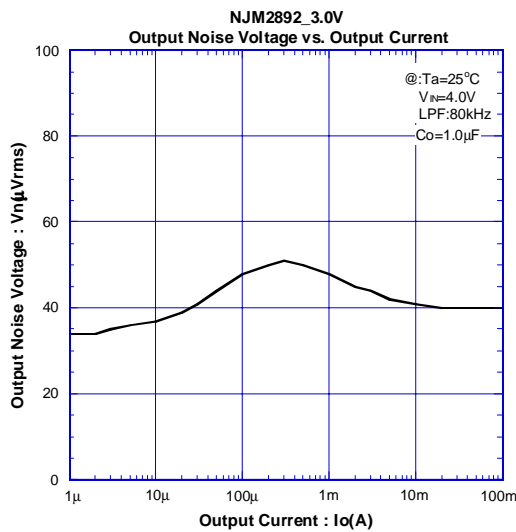
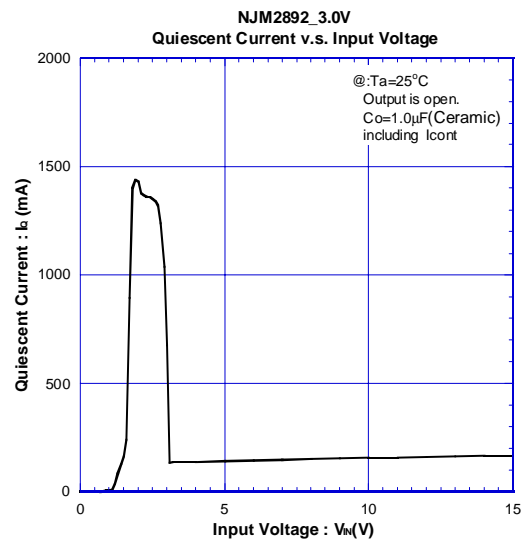
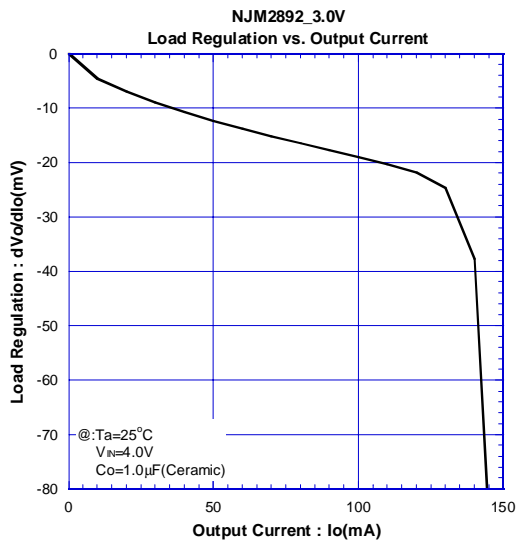

ELECTRICAL CHARACTERISTICS

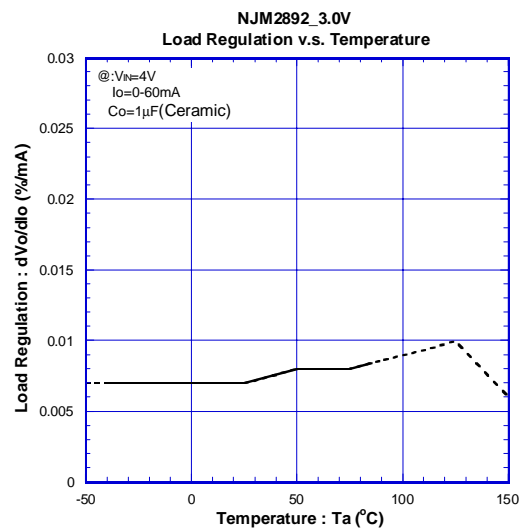
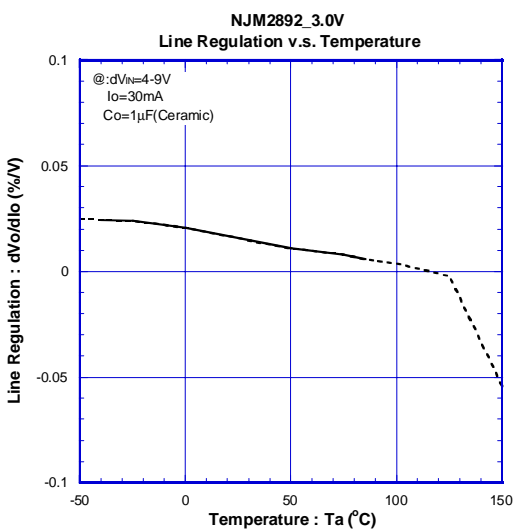
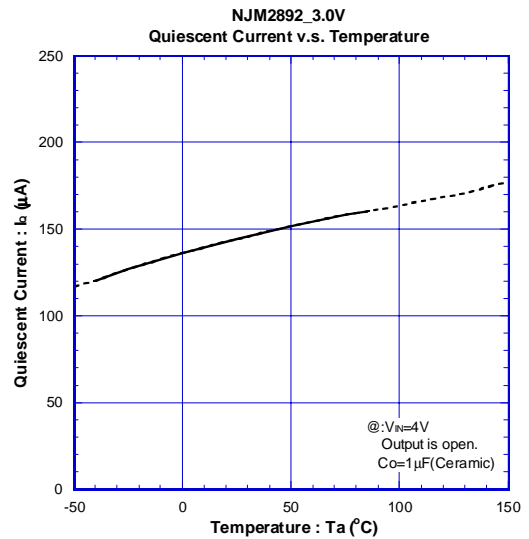
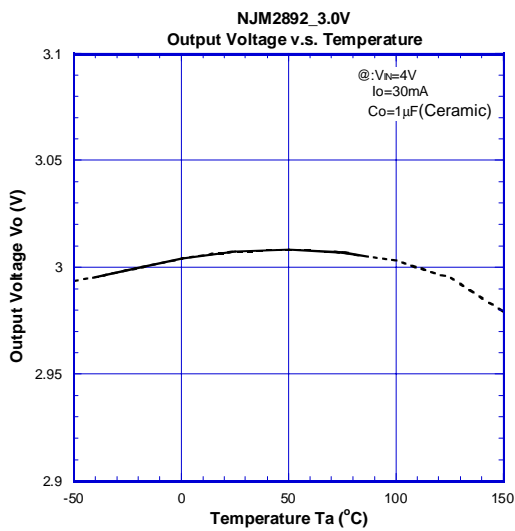
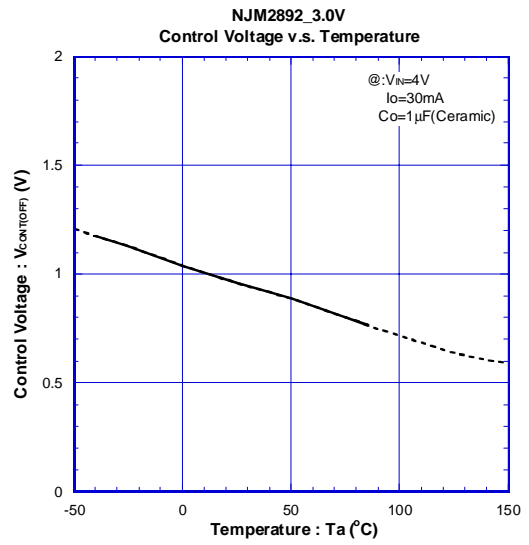
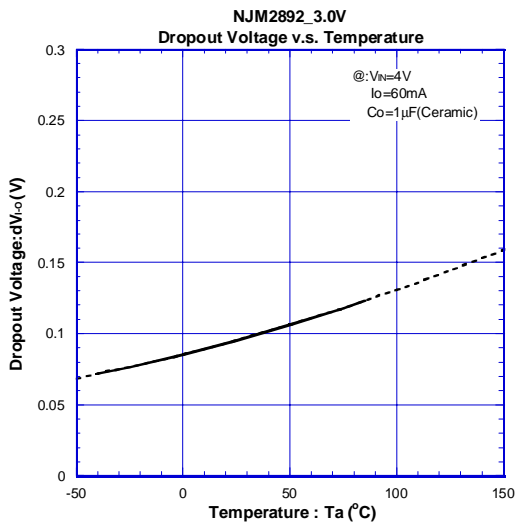

NJM2892

ELECTRICAL CHARACTERISTICS

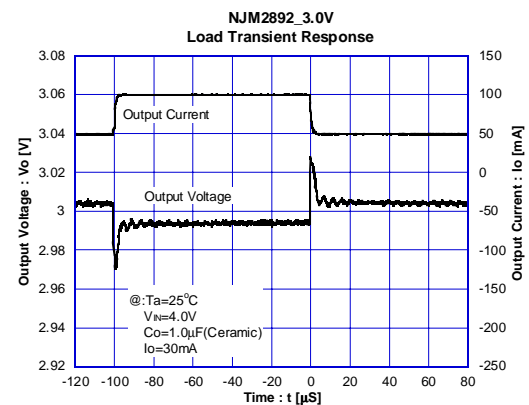
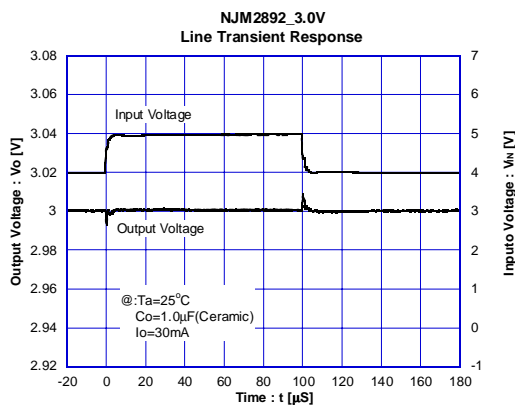
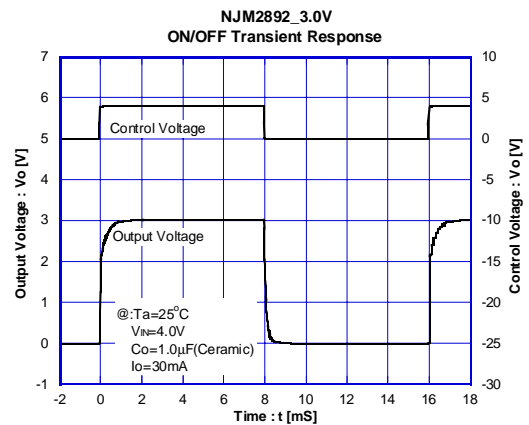
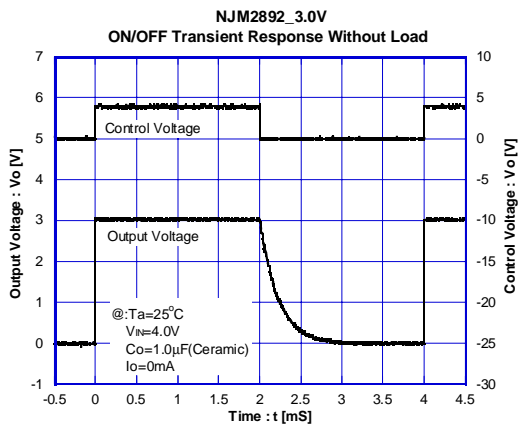
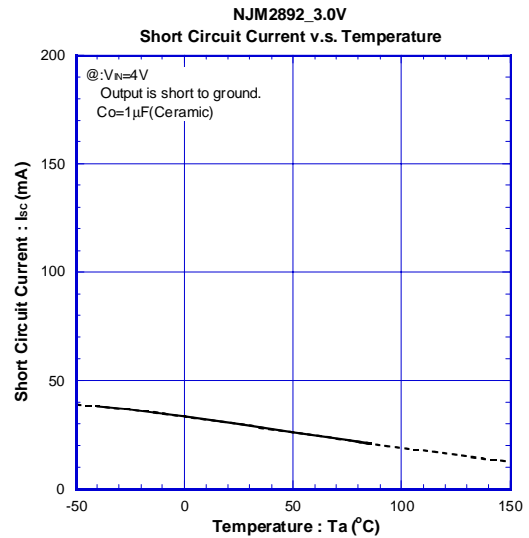
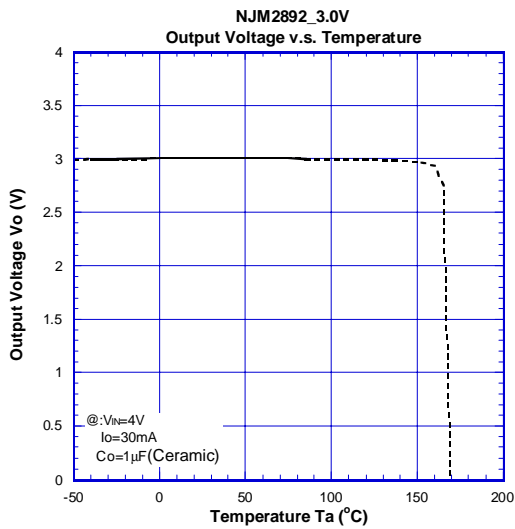

[CAUTION]

The specifications on this databook are only given for information, without any guarantee as regards either mistakes or omissions. The application circuits in this databook are described only to show representative usages of the product and not intended for the guarantee or permission of any right including the industrial rights.