

GaAs Hyperabrupt Varactor Diodes 1.0 Constant Gamma

Rev. V1

Features

- 0 to 22 V Tuning Voltage
- Tuning Ratios up to 10
- Screening Available per:
MIL-PRF-19500 and MIL-PRF-35834
- RoHS* Compliant
- Also Available in 0.75 and 1.25 Constant Gamma Families: MGV075-x and MGV125-x

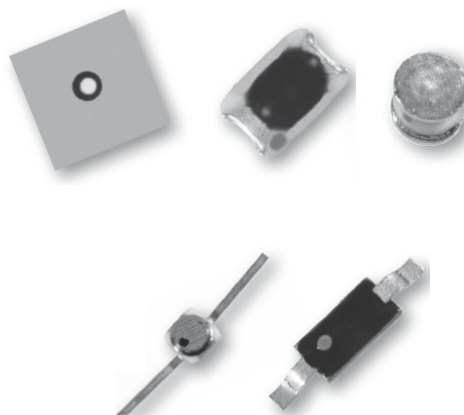

Description

The MGV series of hyperabrupt varactor diodes feature passivated mesa construction for low leakage and excellent post tuning drift. Available in three constant gamma families of 0.75, 1.0 and 1.25.

These diodes will find application in tunable filters and oscillators up to 40 GHz. Optimum performance is obtained using die however packaged devices are available as well screened per MIL-PRF-19500 and MIL-PRF-38534.

Chip (C01A)

Electrical Specifications: $T_A = +25^\circ\text{C}$, $V_B = 22\text{ V min.}$, $I_R = 100\text{ nA max.}$

Model	Total Capacitance (pF)			Tuning Ratio			Q
	$V_R = 4\text{ V, 1 MHz}$			$V_R = 2\text{ to }12$		$V_R = 2\text{ to }20$	$V_R = 4\text{ V, 50 MHz}$
	Min.	Nom.	Max.	Min.	Typ.	Typ.	Min.
MGV100-08	0.30	0.35	0.40	2.7	3.4	5.0	4,000
MGV100-09	0.40	0.45	0.50	2.7	3.4	5.0	4,000
MGV100-20	0.50	0.55	0.61	2.7	3.4	5.0	4,000
MGV100-21	0.58	0.65	0.72	2.7	3.4	5.0	4,000
MGV100-22	0.72	0.80	0.88	2.7	3.4	5.0	3,000
MGV100-23	0.90	1.00	1.10	2.7	3.4	5.0	3,000
MGV100-24	1.08	1.20	1.32	2.7	3.4	5.0	3,000
MGV100-25	1.35	1.50	1.65	2.7	3.4	5.0	3,000
MGV100-26	1.63	1.70	1.87	2.7	3.4	5.0	3,000
MGV100-27	1.80	2.00	2.20	2.7	3.4	5.0	3,000

* Restrictions on Hazardous Substances, European Union Directive 2011/65/EU.

MGV100-x Series



GaAs Hyperabrupt Varactor Diodes 1.0 Constant Gamma

Rev. V1

Packaged (E28, 28X, H20, P55, 0805-2)

Electrical Specifications: $T_A = +25^\circ\text{C}$, $V_B = 22\text{ V min.}$, $I_R = 100\text{ nA max.}$

Model	Total Capacitance (pF)			Tuning Ratio			Q
	$V_R = 4\text{ V, 1 MHz}$			$V_R = 2\text{ to }12$		$V_R = 2\text{ to }20$	$V_R = 4\text{ V, 50 MHz}$
	Min.	Nom.	Max.	Min.	Typ.	Typ.	Min.
MGV100-08-E28 / 28 X	0.37	0.43	0.49	1.9	2.7	4.0	4,000
MGV100-08H20	0.46	0.53	0.61	0.8	1.9	2.8	4,000
MGV100-08-P55	0.41	0.48	0.55	1.4	2.3	3.4	4,000
MGV100-08-0805-2	0.35	0.41	0.47	2.1	2.9	4.3	4,000
MGV100-09-E28 / 28 X	0.47	0.53	0.59	2.1	2.9	4.2	4,000
MGV100-09-H20	0.56	0.63	0.71	1.3	2.2	3.2	4,000
MGV100-09-P55	0.51	0.58	0.65	1.7	2.5	3.7	4,000
MGV100-09-0805-2	0.45	0.51	0.57	2.2	3.0	4.4	4,000
MGV100-20-E28 / 28 X	0.57	0.63	0.70	2.2	3.0	4.3	4,000
MGV100-20-H20	0.66	0.73	0.82	1.6	2.4	3.5	4,000
MGV100-20-P55	0.61	0.68	0.76	1.9	2.7	3.9	4,000
MGV100-20-0805-2	0.55	0.61	0.68	2.3	3.1	4.5	4,000
MGV100-21-E28 / 28 X	0.65	0.73	0.81	2.3	3.0	4.4	4,000
MGV100-21-H20	0.74	0.83	0.93	1.7	2.6	3.8	4,000
MGV100-21-P55	0.69	0.78	0.87	2.0	2.8	4.1	4,000
MGV100-21-0805-2	0.63	0.71	0.79	2.4	3.1	4.6	4,000
MGV100-22-E28 / 28 X	0.79	0.88	0.97	2.4	3.1	4.5	3,000
MGV100-22-H20	0.88	0.98	1.09	1.9	2.7	4.0	3,000
MGV100-22-P55	0.83	0.93	1.03	2.1	2.9	4.3	3,000
MGV100-22-0805-2	0.77	0.86	0.95	2.4	3.2	4.7	3,000
MGV100-23-E28 / 28 X	0.97	1.08	1.19	2.4	3.2	4.6	3,000
MGV100-23-H20	1.06	1.18	1.31	2.1	2.8	4.2	3,000
MGV100-23-P55	1.01	1.13	1.25	2.3	3.0	4.4	3,000
MGV100-23-0805-2	0.95	1.06	1.17	2.5	3.2	4.7	3,000
MGV100-24-E28 / 28 X	1.15	1.28	1.41	2.5	3.2	4.7	3,000
MGV100-24-H20	1.24	1.38	1.53	2.2	2.9	4.3	3,000
MGV100-24-P55	1.19	1.33	1.47	2.3	3.1	4.5	3,000
MGV100-24-0805-2	1.13	1.26	1.39	2.5	3.2	4.8	3,000
MGV100-25-E28 / 28 X	1.42	1.58	1.74	2.5	3.2	4.8	3,000
MGV100-25-H20	1.51	1.68	1.86	2.3	3.0	4.5	3,000
MGV100-25-P55	1.46	1.63	1.80	2.4	3.1	4.6	3,000
MGV100-25-0805-2	1.40	1.56	1.72	2.6	3.3	4.8	3,000
MGV100-26-E28 / 28 X	1.70	1.78	1.96	2.5	3.3	4.8	3,000
MGV100-26-H20	1.79	1.88	2.08	2.4	3.1	4.5	3,000
MGV100-26-P55	1.74	1.83	2.02	2.5	3.2	4.7	3,000
MGV100-26-0805-2	1.68	1.76	1.94	2.6	3.3	4.8	3,000
MGV100-27-E28 / 28 X	1.87	2.08	2.29	2.6	3.3	4.8	3,000
MGV100-27-H20	1.96	2.18	2.41	2.4	3.1	4.6	3,000
MGV100-27-P55	1.91	2.13	2.35	2.5	3.2	4.7	3,000
MGV100-27-0805-2	1.85	2.06	2.27	2.6	3.3	4.9	3,000

2

M/A-COM Technology Solutions Inc. (MACOM) and its affiliates reserve the right to make changes to the product(s) or information contained herein without notice. Visit www.macom.com for additional data sheets and product information.

For further information and support please visit:
<https://www.macom.com/support>

Typical Performance, Chips

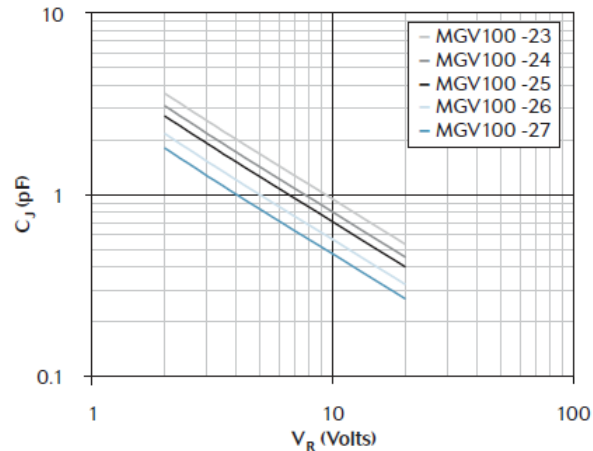
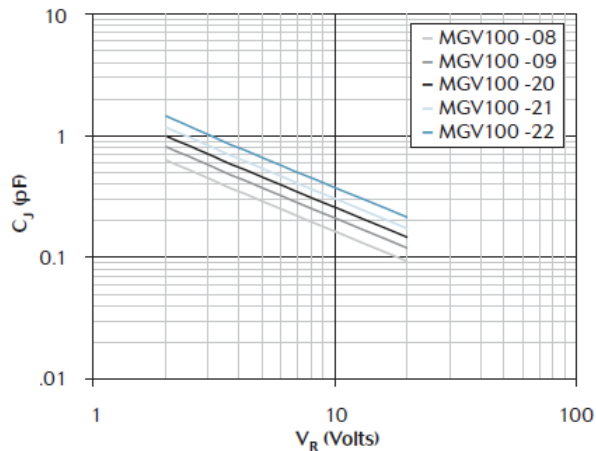

Chip Outline Drawings

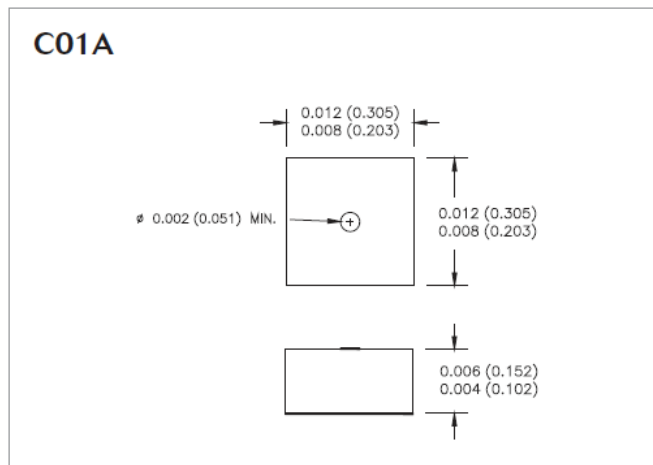

Packaged Outline Drawings

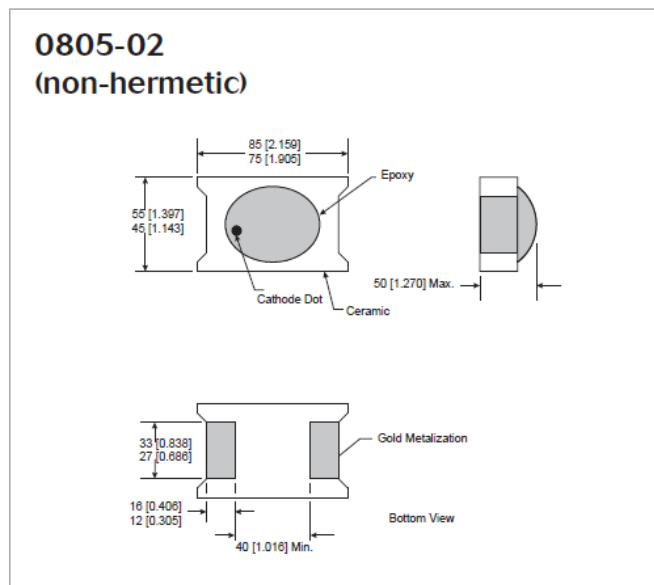
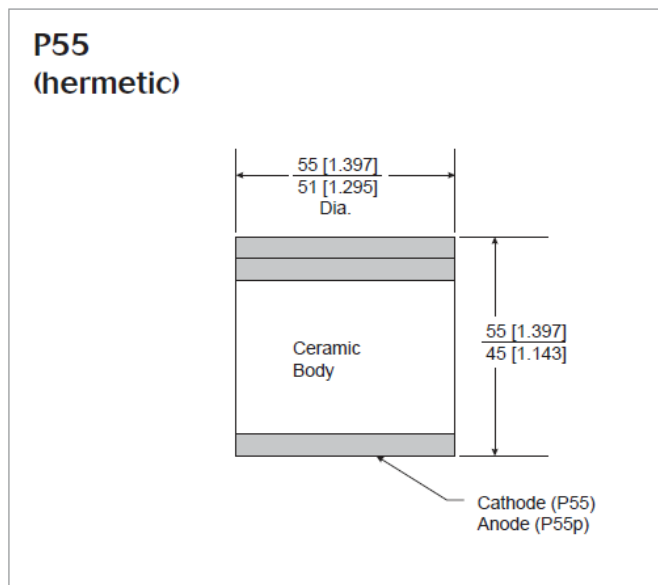
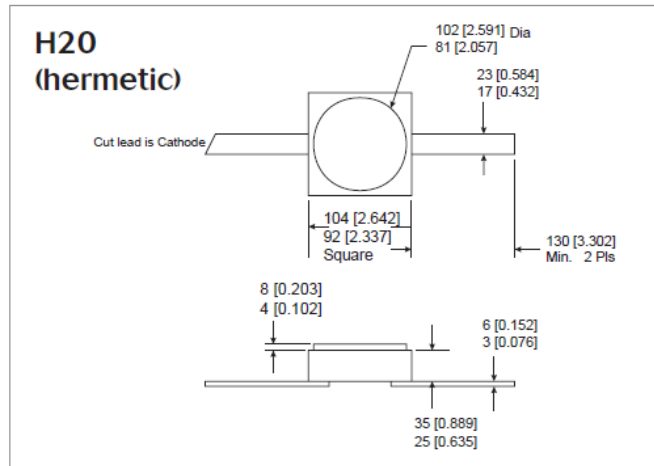
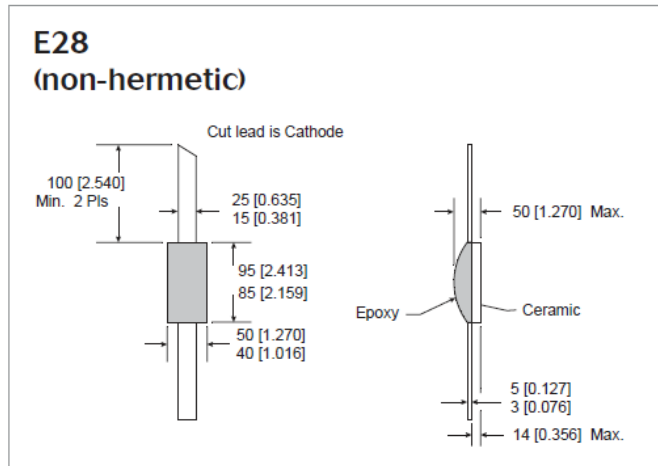

Package Style	Capacitance @ 1 GHz	Inductance @ 1 GHz
E28 / 28X	0.08	0.40
H20	0.18	0.50
P55	0.13	0.35
0805-2	0.06	0.40

M/A-COM Technology Solutions Inc. All rights reserved.

Information in this document is provided in connection with M/A-COM Technology Solutions Inc ("MACOM") products. These materials are provided by MACOM as a service to its customers and may be used for informational purposes only. Except as provided in MACOM's Terms and Conditions of Sale for such products or in any separate agreement related to this document, MACOM assumes no liability whatsoever. MACOM assumes no responsibility for errors or omissions in these materials. MACOM may make changes to specifications and product descriptions at any time, without notice. MACOM makes no commitment to update the information and shall have no responsibility whatsoever for conflicts or incompatibilities arising from future changes to its specifications and product descriptions. No license, express or implied, by estoppel or otherwise, to any intellectual property rights is granted by this document.

THESE MATERIALS ARE PROVIDED "AS IS" WITHOUT WARRANTY OF ANY KIND, EITHER EXPRESS OR IMPLIED, RELATING TO SALE AND/OR USE OF MACOM PRODUCTS INCLUDING LIABILITY OR WARRANTIES RELATING TO FITNESS FOR A PARTICULAR PURPOSE, CONSEQUENTIAL OR INCIDENTAL DAMAGES, MERCHANTABILITY, OR INFRINGEMENT OF ANY PATENT, COPYRIGHT OR OTHER INTELLECTUAL PROPERTY RIGHT. MACOM FURTHER DOES NOT WARRANT THE ACCURACY OR COMPLETENESS OF THE INFORMATION, TEXT, GRAPHICS OR OTHER ITEMS CONTAINED WITHIN THESE MATERIALS. MACOM SHALL NOT BE LIABLE FOR ANY SPECIAL, INDIRECT, INCIDENTAL, OR CONSEQUENTIAL DAMAGES, INCLUDING WITHOUT LIMITATION, LOST REVENUES OR LOST PROFITS, WHICH MAY RESULT FROM THE USE OF THESE MATERIALS.

MACOM products are not intended for use in medical, lifesaving or life sustaining applications. MACOM customers using or selling MACOM products for use in such applications do so at their own risk and agree to fully indemnify MACOM for any damages resulting from such improper use or sale.