

**RoHS  HF 466 Series Fuse**

### Description



The 466 Series Fast-Acting Surface Mount Fuse (SMF) is a small (1206 size) thin-film device designed for secondary protection of circuits used in space constrained applications such as hand-held portable electronic devices.

This series is 100% lead-free and meets the requirements of the RoHS directive. New Halogen-Free 466 Series fuses are available to order using the "HF" suffix. See Part Numbering section for additional information.

### Features

- Product is compatible with lead-free solders and higher temperature profiles
- Product is marked on top surface with code to allow amperage rating identification without testing
- Low profile for height sensitive applications
- Flat top surface for pick-and-place operations
- Element-covering material is resistant to industry standard cleaning operations
- Mounting pad and electrical performance are identical to Littelfuse 429 and 433 Series products
- Alloy-based element construction provides superior inrush withstand characteristics (I<sup>2</sup>t) over ceramic or glass-based 1206 chip fuse products

### Agency Approvals

AGENCY	AGENCY FILE NUMBER	AMPERE RANGE
	E10480	125mA - 5A
	LR29862	125mA - 5A

### Electrical Characteristics for Series



% of Ampere Rating	Opening Time at 25°C
100%	4 hours, Minimum
200%	5 sec., Maximum
300%	0.2 sec., Maximum

### Applications

Secondary protection for space constrained applications:

- Cell phones
- Battery packs
- Digital cameras
- DVD players
- Hard disk drives

### Electrical Specifications by Item

Ampere Rating (A)	Amp Code	Max Voltage Rating (V)	Interrupting Rating	Nominal Cold Resistance (Ohms)	Nominal Melting I <sup>2</sup> t (A <sup>2</sup> sec)	Nom Voltage Drop (mV)	Nom Power Dissipation (W)	Agency Approvals	
									
0.125	.125	125	50A @125 V AC/DC	4.000	0.00040	552.66	0.0691	x	x
0.200	.200	125		1.160	0.00055	254.28	0.0509	x	x
0.250	.250	125		0.710	0.0010	207.01	0.0518	x	x
0.375	.375	125	50A @63 V AC/DC	0.350	0.0028	169.18	0.0634	x	x
0.500	.500	63		0.248	0.0060	158.47	0.0792	x	x
0.750	.750	63		0.111	0.0276	98.65	0.0740	x	x
1.00	001.	63		0.076	0.0423	89.94	0.0899	x	x
1.25	1.25	63		0.059	0.0640	85.71	0.1071	x	x
1.50	01.5	63		0.048	0.1103	82.97	0.1244	x	x
1.75	1.75	63	50A @32 V AC/DC	0.039	0.1323	80.73	0.1413	x	x
2.00	002.	63		0.031	0.2326	78.73	0.1575	x	x
2.50	02.5	32		0.024	0.3516	76.99	0.1925	x	x
3.00	003.	32		0.020	0.5760	75.99	0.2280	x	x
4.00	004.	32		0.014	1.024	74.50	0.2980	x	x
5.00	005.	32	0.011	1.600	73.75	0.3688	x	x	

1. Measured at 10% of rated current, 25°C.

2. Measured at rated voltage.

### Temperature Derating Curve

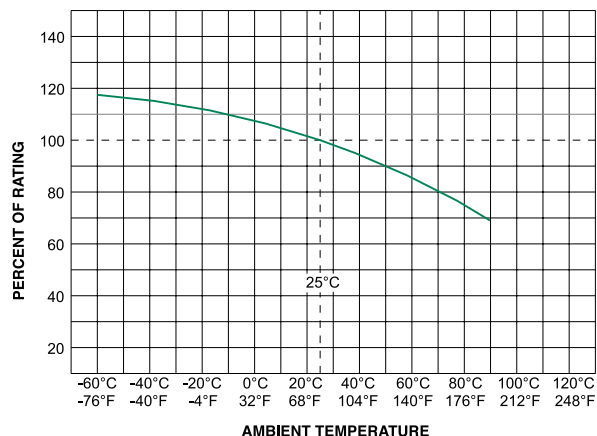

Note:

1. Derating depicted in this curve is in addition to the standard rating of 25% for continuous operation.

Example:

For continuous operation at 70 degrees celsius, the fuse should be rated as follows:

$$I = (0.75)(0.80)I_{RAT} = (0.60)I_{RAT}$$

2. The temperature derating curve represents the nominal conditions. For questions about temperature derating curve, please consult Littelfuse technical support for assistance.

### Average Time Current Curves

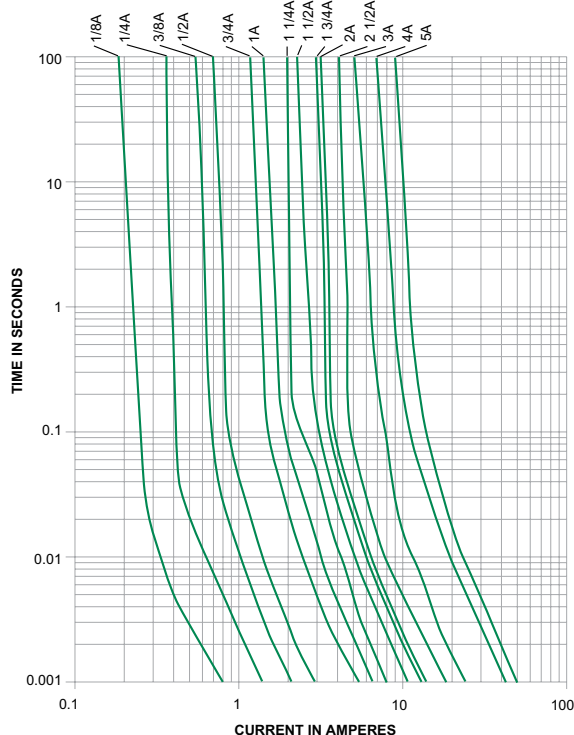

### Soldering Parameters

Reflow Condition		Pb – free assembly
Pre Heat	- Temperature Min ( $T_{s(min)}$ )	150°C
	- Temperature Max ( $T_{s(max)}$ )	200°C
	- Time (Min to Max) ( $t_s$ )	60 – 180 seconds
Average Ramp-up Rate (Liquidus Temp ( $T_L$ ) to peak)		5°C/second max.
$T_{s(max)}$ to $T_L$ - Ramp-up Rate		5°C/second max.
Reflow	- Temperature ( $T_L$ ) (Liquidus)	217°C
	- Temperature ( $t_L$ )	60 – 150 seconds
Peak Temperature ( $T_p$ )		250 <sup>+0/-5</sup> °C
Time within 5°C of actual peak Temperature ( $t_p$ )		20 – 40 seconds
Ramp-down Rate		5°C/second max.
Time 25°C to peak Temperature ( $T_p$ )		8 minutes max.
Do not exceed		260°C

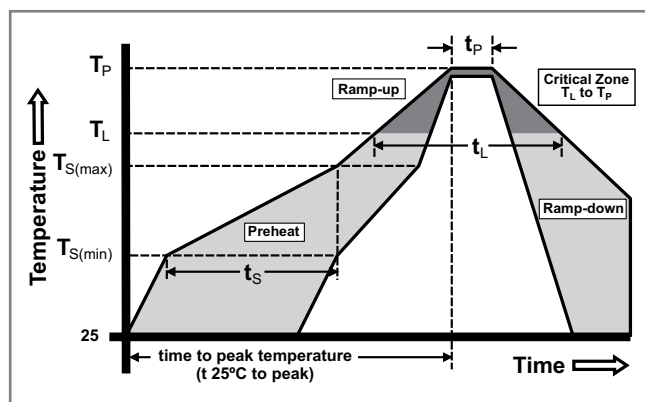

Wave Soldering

260°C, 10 seconds max.

## Product Characteristics

<b>Materials</b>	<b>Body:</b> Advanced High Temperature Substrate <b>Terminations:</b> 100% Tin over Nickel over Copper <b>Element Cover Coat:</b> Conformal Coating
<b>Operating Temperature</b>	- 55°C to 90°C. Consult temperature derating curve chart.
<b>Thermal Shock</b>	Withstands 5 cycles of -55°C to 125°C
<b>Humidity</b>	MIL-STD-202F, Method 103B, Condition D

<b>Vibration</b>	Per MIL-STD-202F, Method 201A
<b>Insulation Resistance (After Opening)</b>	Greater than 10,000 ohms
<b>Resistance to Soldering Heat</b>	MIL-STD-202G, Method 210F, Condition D

## Dimensions

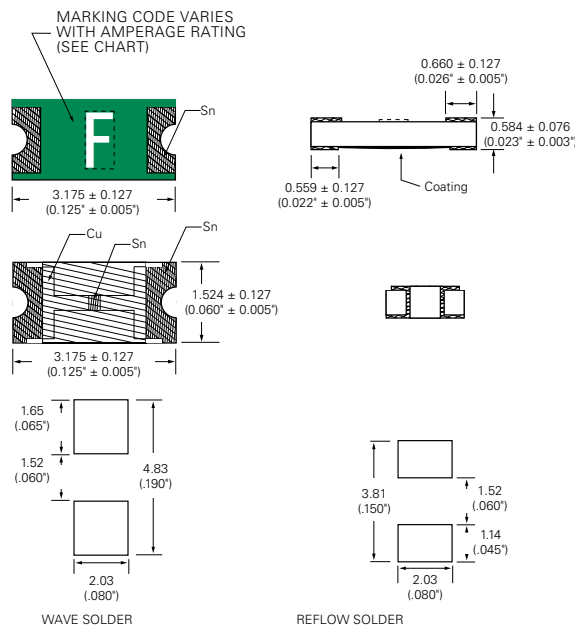

## Part Marking System

Amp Code	Marking Code
.125	<b>B</b>
.200	<b>C</b>
.250	<b>D</b>
.375	<b>E</b>
.500	<b>F</b>
.750	<b>G</b>
001.	<b>H</b>
1.25	<b>J</b>
01.5	<b>K</b>
1.75	<b>L</b>
002.	<b>N</b>
02.5	<b>O</b>
003.	<b>P</b>
004.	<b>S</b>
005.	<b>T</b>

## Part Numbering System

**0466002.NRHF**

**SERIES**

**AMP Code**

Refer to Amp Code column in the Electrical Specifications table. The dot is positioned before the Packaging Suffix with whole ratings and within the numbering sequence for fractional ratings.

**QUANTITY Code**

N = 5000 pcs

**PACKAGING Code**

R = Tape and Reel

**'HF' SUFFIX**

**HALOGEN FREE ITEM**

**Example:**

.125 amp product is 0466.**125** NR HF (2 amp product shown above).

## Packaging

Packaging Option	Packaging Specification	Quantity	Quantity & Packaging Code
8mm Tape and Reel	EIA-481 Rev. D (IEC 60286, part 3)	5000	NR