

REVISIONS			
REV	ECN, ERN NO.	DATE	APPRD.
J	PRODUCT DRAWING (EAR13166)	SEP26/07	K.L.

ORDERING CODE: FCC17-E09PM-440G

**SERIES**  
**SIZE/NUMBER OF CONTACTS**  
 E09, A15, B25, OR C37  
**CONNECTOR STYLE**  
 P = PIN  
 S = SOCKET  
**TERMINATION TYPE**  
 M = SOLDER CUP

**CONTACT FINISH/GOLD THICKNESS**  
 NO DIGIT = STANDARD 15 MICRONS  
 [0.38 MICRONS] GOLD  
 G = 50 MICRONS [1.27 MICRONS] GOLD  
**MODIFIER**  
 0 = STANDARD  
**FILTER CAPACITANCE**  
 D = 50 pF    5 = 1000 pF  
 B = 100 pF    7 = 1200 pF  
 0 = 180 pF    E = 2200 pF  
 F = 330 pF    9 = 5600 pF  
 L = 380 pF    8 = 47000 pF  
 1 = 470 pF    N = NO FILTERS  
 4 = 820 pF  
 REFER TO AMPHENOL CATALOGUE FOR FILTER PERFORMANCE CHARACTERISTICS

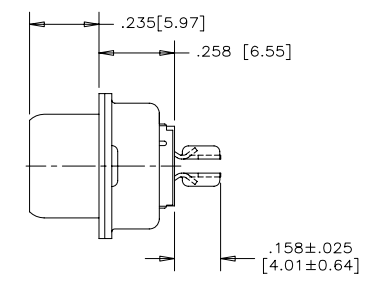
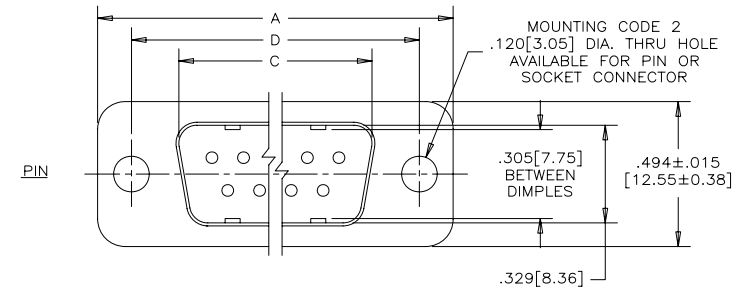
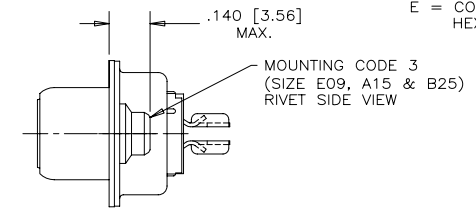
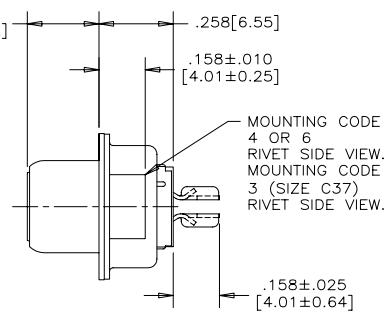
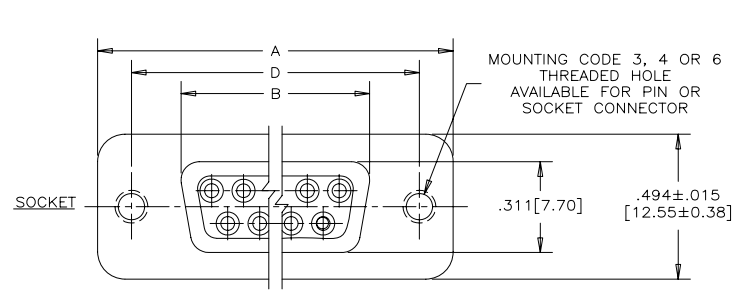
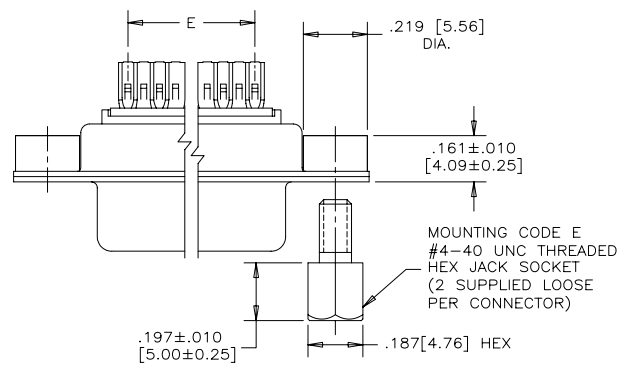

**NOTES:**

- MATERIALS: - SHELLS - TIN PLATED STEEL  
 - CONTACTS - PHOSPHOR BRONZE PLATED WITH GOLD OVER NICKEL ON THE MATING AREA AND TIN-LEAD ON THE TERMINALS  
 - INSULATOR - ENGINEERING THERMOPLASTIC, FLAMMABILITY RATING UL94V-0, BLACK.
- CONTACT RESISTANCE: 15 MILLIOHMS MAXIMUM.
- INSULATION RESISTANCE: 3000 MEGOHMS MINIMUM
- CURRENT RATING: 5 AMPS MAXIMUM  
 2 AMPS FILTERING MAXIMUM
- OPERATING TEMPERATURE: -40°C TO 85°C.
- TOLERANCE, UNLESS INDICATED OTHERWISE, ±.005 [0.13].

SIZE	STYLE	A±.015 [0.38]	B±.005 [0.13]	C±.005 [0.13]	D±.005 [0.13]	E BSC.
E09	PIN	1.213 [30.81]	-----	.666 [16.92]	.984 [24.99]	.432 [10.97]
	SOCKET		.643 [16.33]	-----		
A15	PIN	1.541 [39.14]	-----	.994 [25.25]	1.312 [33.32]	.756 [19.20]
	SOCKET		.971 [24.66]	-----		
B25	PIN	2.088 [53.04]	-----	1.534 [38.96]	1.852 [47.04]	1.304 [33.12]
	SOCKET		1.511 [38.38]	-----		
C37	PIN	2.729 [69.32]	-----	2.182 [55.42]	2.500 [63.50]	1.956 [49.68]
	SOCKET		2.159 [54.84]	-----		

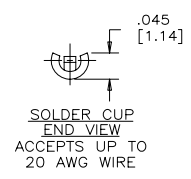

DRAWN I.ESSAJEE	DATE 98/03/09
DESIGNED K.LAMBIE	98/03/04
CHECKED	
I. E. APPRD.	
Q. A. APPRD.	
DWG. APPRD.	
ENG. REL. NO.	
REF.	
DIMENSIONS ARE IN INCHES [mm]	CODE ID. NO. 03554

Amphenol Canada Corp.			
TITLE		FCC17 FILTERED D-SUB CONNECTOR, PIN & SOCKET, SOLDER CUP CONTACTS	
DWG	DRAWING NO.	REV.	
C	P-FCC17-XXXXM-XXOX	J	
SCALE	3/1	WT.	-----
SURF.	-----	SHEET	1 OF 1

THIS DOCUMENT CONTAINS PROPRIETARY INFORMATION AND SUCH INFORMATION MAY NOT BE DISCLOSED TO OTHERS FOR ANY PURPOSE OR USED FOR MANUFACTURING PURPOSES WITHOUT WRITTEN PERMISSION FROM AMPHENOL CANADA CORP.