

Bandpass Filter 253054B



1. Features

- IF bandpass filter
- Low-Loss Filter
- Single-ended operation
- Ceramic Surface Mount Device(SMD) Package
- Maximum Storage Temperature Range : -40℃ ~ 85℃
- Electrostatics Sensitive Device (ESD)

2. Package Dimension

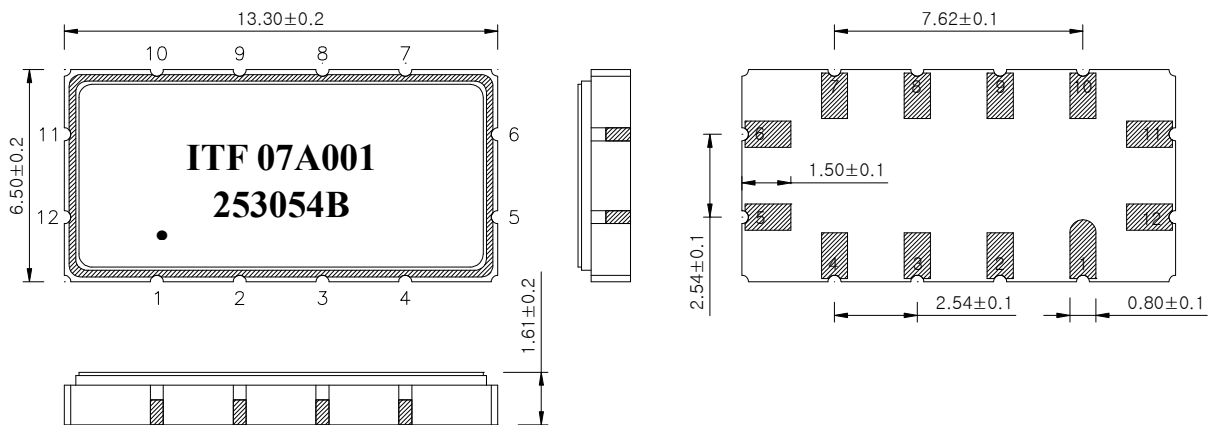

Package : S1365

Dimensions shown are nominal in millimeters

Body : Al₂O₃

Lid : Kovar, Ni Plated

Termination : Au plating 0.3 ~ 1.0um, over a 1.27 ~ 8.89um Ni Plating

Pin Configuration	
11	Input
5	Output
6, 12	Ground
Other	Case ground

	ITF Co., Ltd. 102-901, Bucheon Technopark 364, Samjeong-Dong, Ojeong-Gu, Bucheon-City, Gyeonggi-Do, Korea 421-809	Part No.	253054B	
		Rev. Date	2008-04-15	
		Rev.	NJ7017-AS01	1/5

Bandpass Filter 253054B



3. Specifications

Fo = 125.0 MHz

Terminating source impedance : 50Ω and matching network

Terminating load impedance : 50Ω and matching network

Room temperature range : +25°C		Minimum	Typical	Maximum
Center Frequency (Fc)	MHz	-	125.0	-
Insertion Loss	dB	-	18.5	21.0
1dB Bandwidth	MHz	28.5	29.6	-
3dB Bandwidth	MHz	-	30.5	-
40dB Bandwidth	MHz	-	35.5	36.0
Amplitude Ripple (Fo +/- 14.05 MHz)	dB	-	0.7	1.0
Group Delay Variation (Fo +/- 14.05 MHz)	nsec	-	40	50
Absolute Delay	usec	-	0.69	-
Relative Attenuation				
10.0 ~ 88.5 MHz	dB	45	50	
88.5 ~ 105.0 MHz	dB	40	45	
147.0 ~ 320.0 MHz	dB	45	50	
320.0 ~ 500.0 MHz	dB	45	50	
Temperature Coefficient of Frequency	ppm/°C	-	- 86	-

Notes :

- 1) All specifications are based on the matching schematic shown below
- 2) All specifications are measured by Agilent Network analyzer and full 2 port calibration
- 3) Electrical margin has been built into the design to account for the variations due to temperature drift and manufacturing tolerances
- 4) All attenuation measurements are measured relative to insertion loss

 Integrated Technology Future	ITF Co., Ltd. 102-901, Bucheon Technopark 364, Samjeong-Dong, Ojeong-Gu, Bucheon-City, Gyeonggi-Do, Korea 421-809	Part No.	253054B	
		Rev. Date	2008-04-15	
		Rev.	NJ7017-AS01	2/5

Bandpass Filter 253054B



4. Matching Schematic

(Actual matching values may vary due to PCB layout and parasitics)

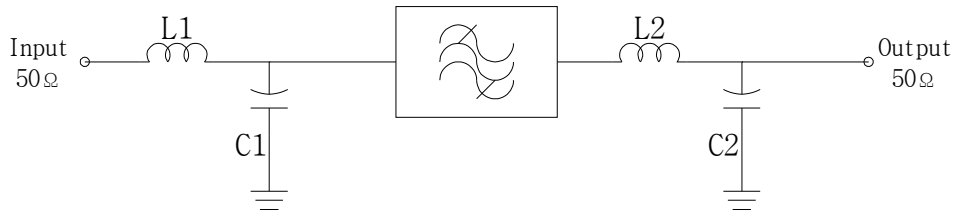

L1 = 82 nH, L2 = 47 nH
 C1 = 13 pF, C2 = 36 pF

5. Marking Configuration

ITF¹⁾ 07A001²⁾

253054B³⁾

●⁴⁾

- 1) Manufacturer name
- 2) Lot Number
- 3) Part Number
- 4) Pad Number 1 Index

	ITF Co., Ltd. 102-901, Bucheon Technopark 364, Samjeong-Dong, Ojeong-Gu, Bucheon-City, Gyeonggi-Do, Korea 421-809	Part No.	253054B	
		Rev. Date	2008-04-15	
		Rev.	NJ7017-AS01	3/5

Bandpass Filter 253054B



6. Typical Performance (at +25°C)

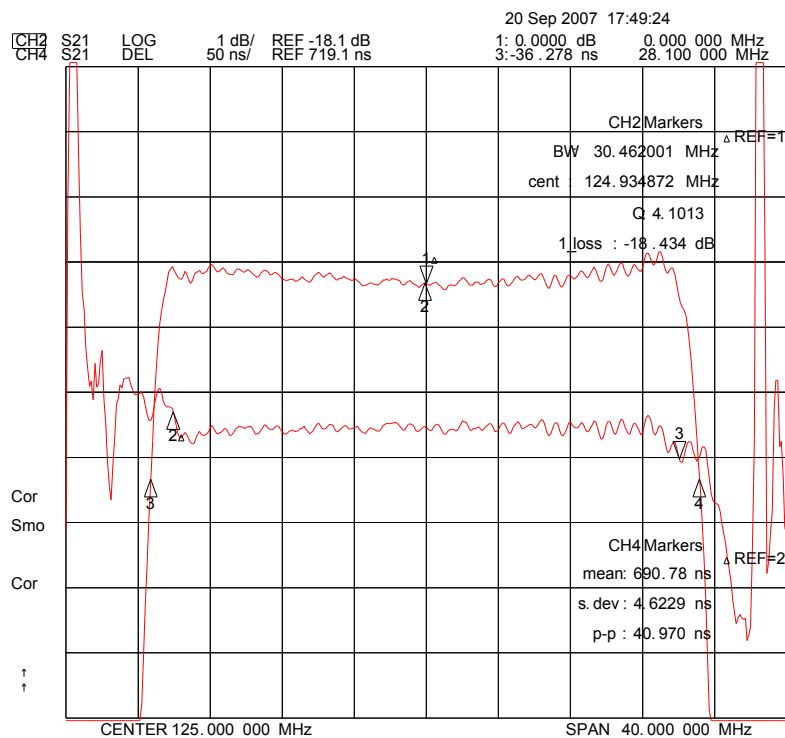
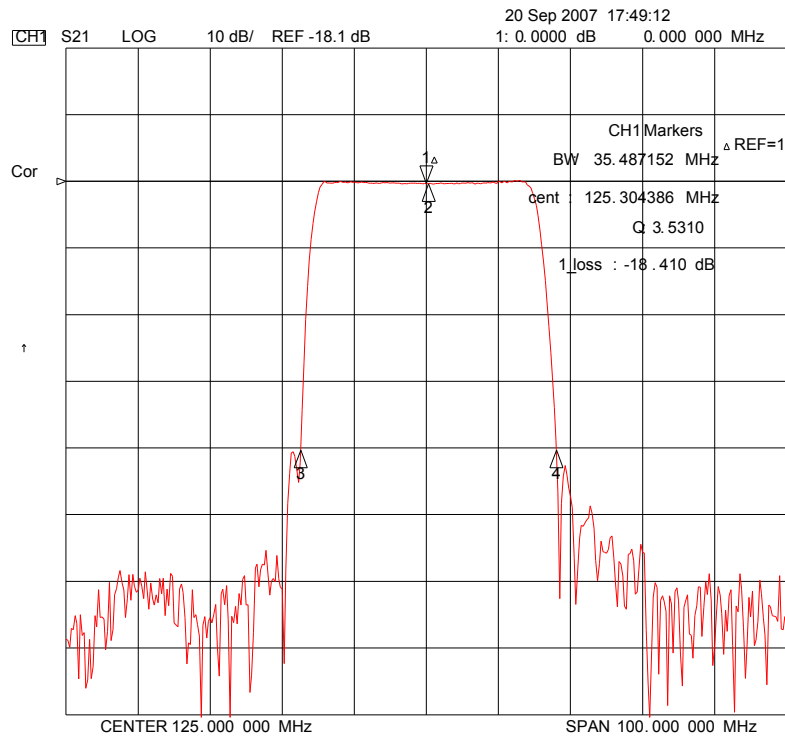

	ITF Co., Ltd. 102-901, Bucheon Technopark 364, Samjeong-Dong, Ojeong-Gu, Bucheon-City, Gyeonggi-Do, Korea 421-809	Part No.	253054B	
		Rev. Date	2008-04-15	
		Rev.	NJ7017-AS01	4/5

Bandpass Filter 253054B

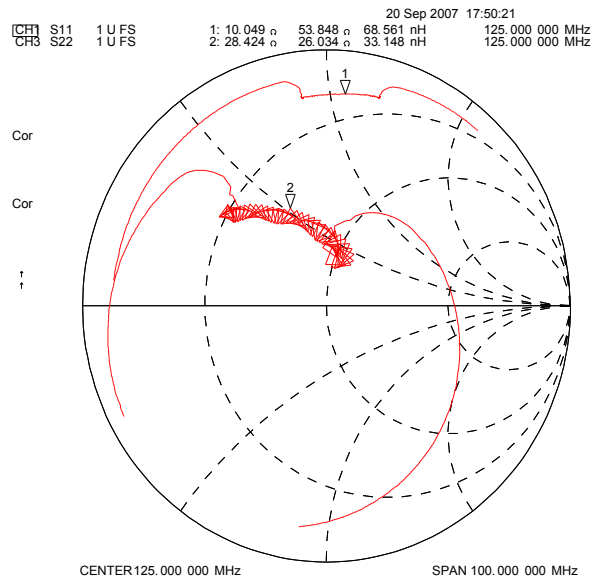
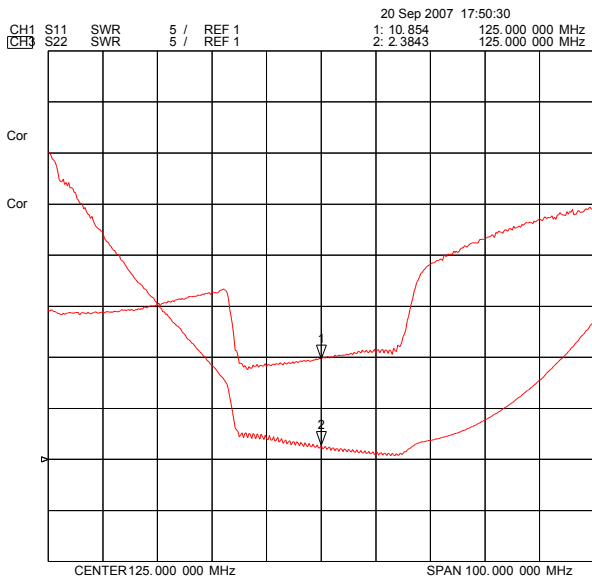
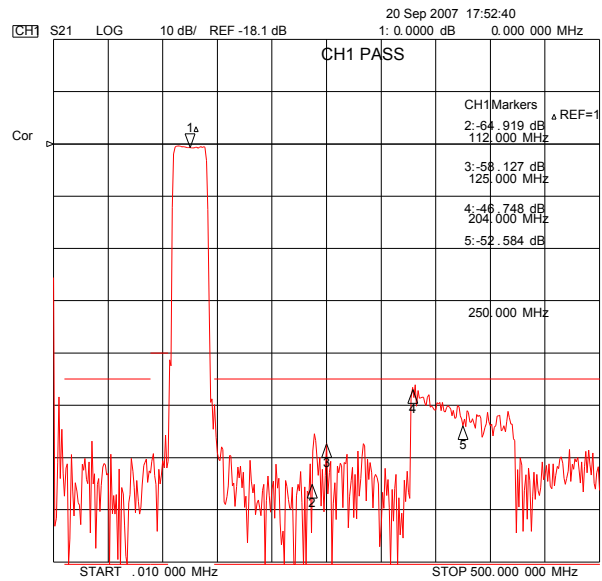
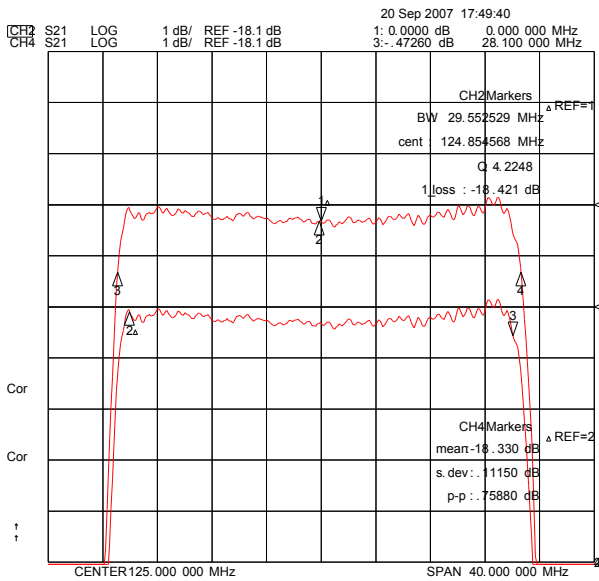

ITF Co., Ltd.
 102-901, Bucheon Technopark 364,
 Samjeong-Dong, Ojeong-Gu, Bucheon-City,
 Gyeonggi-Do, Korea 421-809

Part No.	253054B	
Rev. Date	2008-04-15	
Rev.	NJ7017-AS01	5/5