

ANT-5GMFPC1-UFL-100 Flexible Embedded Midband 5G Antenna

The Linx 5GMFPC1 antenna is a flexible embedded multiband antenna for 5G New Radio midband applications. With excellent performance from 2300 MHz to 5000 MHz the 5GMFPC1 supports 5G band 40 (2300 MHz to 2400 MHz), 5G band n90 (2496 MHz to 2690 MHz), CBRS private cellular networking (3550 MHz to 3700 MHz), 5G band n78 (3300 MHz to 3800 MHz), 5G band n79 (4400 MHz to 5000 MHz), and a growing number of 5G midband solutions.

The 5GMFPC1 provides a ground plane independent embedded antenna solution comparable in performance to an external antenna. The flexibility and adhesive backing makes the 5GMFPC1 antenna easy to mount in unique and custom enclosures, while enabling an environmentally sealed enclosure and protection from tampering or accidental antenna damage.

Connection is made to the radio via a 100 mm (3.94 in) long, 1.13 mm coaxial cable terminated in a U.FL-type plug (female socket) connector.

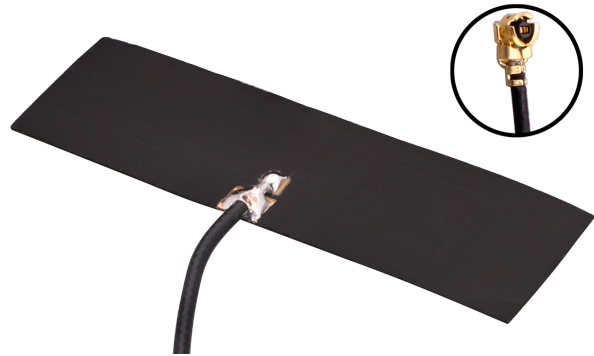

Features

- Performance at 3300 MHz to 3800 MHz
 - VSWR: ≤ 1.7
 - Peak Gain: 4.8 dBi
 - Efficiency: 59%
- Ground plane independent dipole antenna
- Compact, low-profile
 - 42.0 mm x 12.0 mm x 0.2 mm
- U.FL-type plug (female socket) compatible with MHF1, AMC, UMCC
- Adhesive backing permanently adheres to non-metal enclosures using 3M 467MP™/200MP adhesive
- Flexible to fit in challenging enclosures

Applications

- 5G NR midband and LTE applications
- 5G NR/LTE bands 7, 22, 30, 40, 41, 42, 43, 48, 49, 52, n77, n78, n79
- 2.5 GHz EBS/BRS applications
- Private cellular networks
 - Citizens Broadband Radio Service (CBRS)
- Public Safety networks

Ordering Information

| Part Number | Description |
|----------------------------|---|
| ANT-5GMFPC1-UFL-100 | Antenna with 100 mm of 1.13 mm coaxial cable and U.FL-type plug (female socket) |

Available from Linx Technologies and select distributors and representatives.

Electrical Specifications

| ANT-5GMFPC1-UFL | Frequency Range | VSWR (max.) | Peak Gain (dBi) | Avg. Gain (dBi) | Efficiency (%) |
|---------------------------------------|--|-------------|-----------------|-----------------|----------------|
| Band 30, 40 | 2300 MHz to 2400 MHz | 3.2 | 3.0 | -2.6 | 57 |
| Band 7, 41 | 2496 MHz to 2690 MHz | 1.8 | 4.7 | -1.6 | 73 |
| Band 22, 42, 43, 48, 49, 52, n77, n78 | 3300 MHz to 3800 MHz | 1.7 | 4.8 | -2.7 | 59 |
| C-Band, n77 | 3700 MHz to 4200 MHz | 1.6 | 5.9 | -1.9 | 68 |
| Band n79 | 4400 MHz to 5000 MHz | 1.4 | 6.7 | -1.7 | 71 |
| Polarization | Linear | | | | |
| Radiation | Omnidirectional | | | | |
| Max Power | 2 W | | | | |
| Wavelength | 1/2-wave | | | | |
| Electrical Type | Dipole | | | | |
| Impedance | 50 Ω | | | | |
| Connection | U.FL-type plug (female socket) on 100 mm (3.94 in) of 1.13 mm coaxial cable. | | | | |
| Weight | 0.6 g (0.02 oz) | | | | |
| Dimensions | 42.0 mm x 12.0 mm x 0.2 mm (1.65 in x 0.47 in x 0.01 in) | | | | |
| Operating Temp. Range | -40 °C to +80 °C | | | | |

Product Dimensions

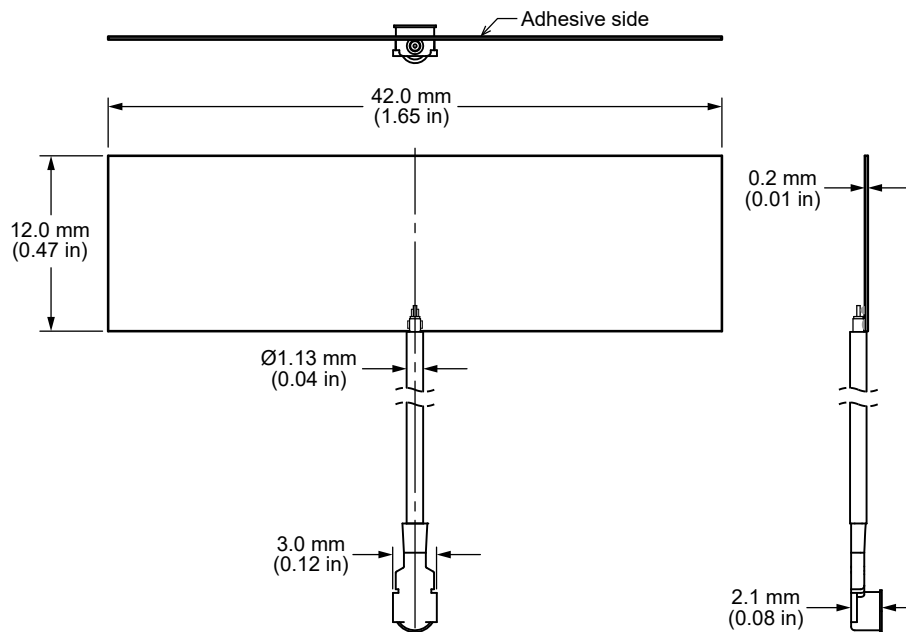

Figure 1. ANT-5GMFPC1-UFL-100 Dimensions

Antenna Mounting

The ANT-5GMFPC1-UFL-100 is a flexible, adhesive backed antenna that allows it to be permanently installed onto non-metallic surfaces. The adhesive backing is 3M 467MP™/200MP, which provides outstanding adhesion to high surface energy plastics. The adhesive delivers excellent shear strength to resist slippage and edge lifting, but can be repositioned temporarily to allow for repositioning. This adhesive is highly resistant to solvents, humidity and moisture, as well as heat up to 204 °C (400 °F) for short periods.

The antenna should never be bent to the point of creating a crease or allowing the angle of the bend to fall below 90 degrees (i.e. become acute) as this will impair function and may cause permanent damage.

VSWR

Figure 2 provides the voltage standing wave ratio (VSWR) across the antenna bandwidth. VSWR describes the power reflected from the antenna back to the radio. A lower VSWR value indicates better antenna performance at a given frequency. Reflected power is also shown on the right-side vertical axis as a gauge of the percentage of transmitter power reflected back from the antenna.

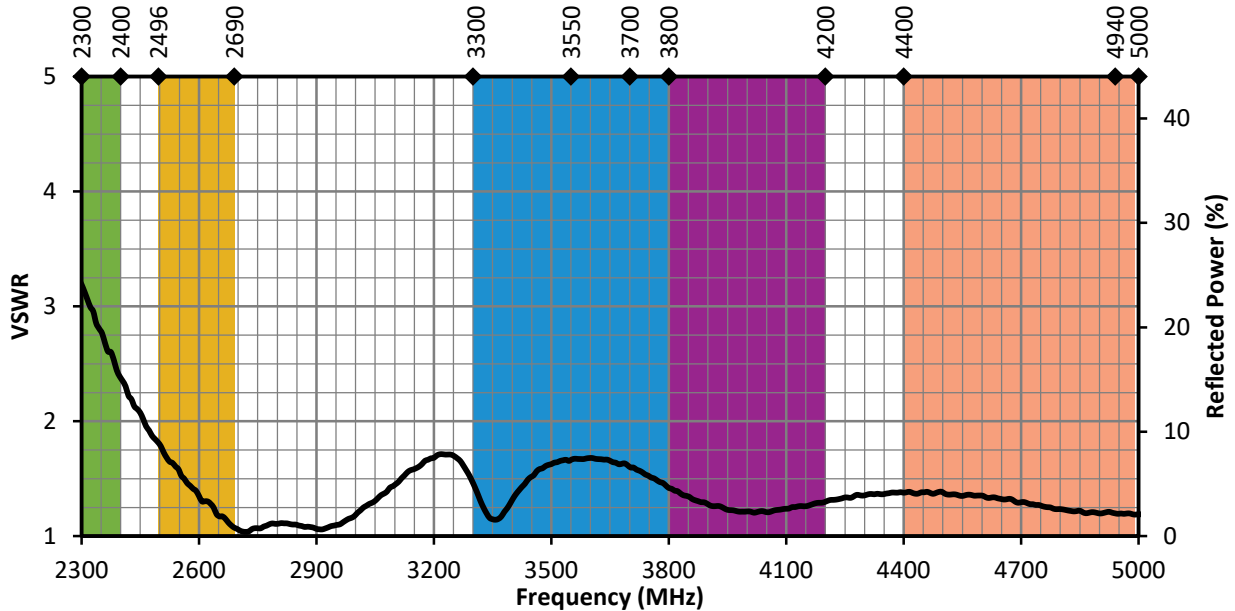

Figure 2. 5GMFPC1 Antenna VSWR with Frequency Band Highlights

Return Loss

Return loss (Figure 3), represents the loss in power at the antenna due to reflected signals. Like VSWR, a lower return loss value indicates better antenna performance at a given frequency.

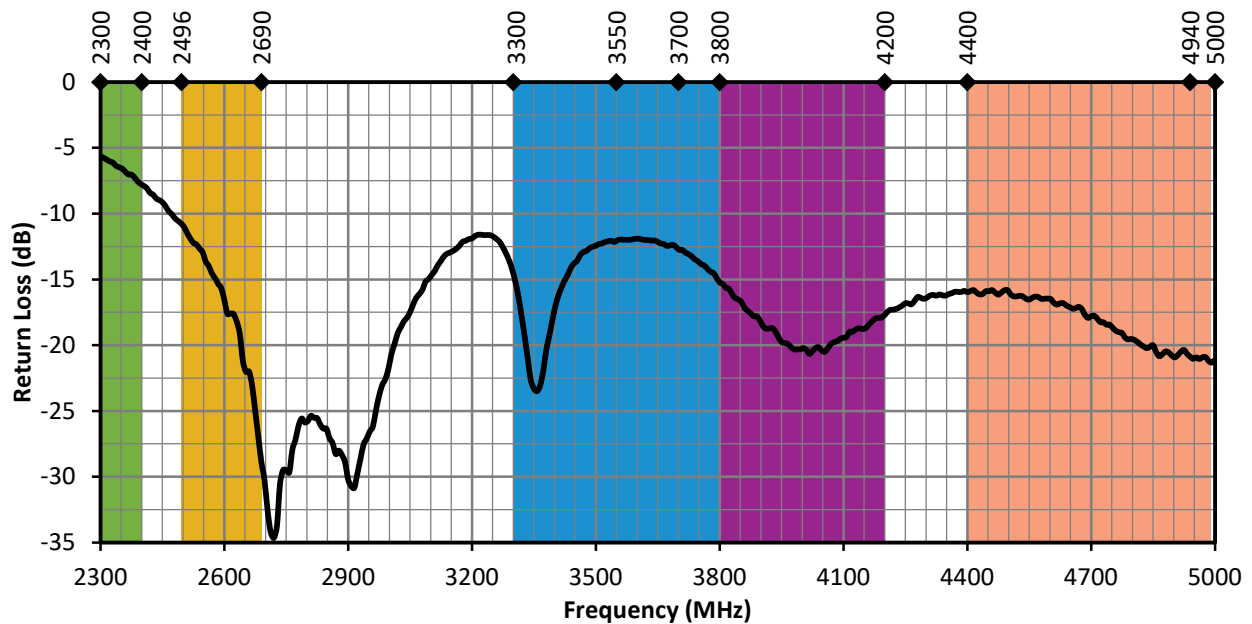

Figure 3. 5GMFPC1 Antenna Return Loss with Frequency Band Highlights

Peak Gain

The peak gain across the antenna bandwidth is shown in Figure 4. Peak gain represents the maximum antenna input power concentration across 3-dimensional space, and therefore peak performance, at a given frequency, but does not consider any directionality in the gain pattern.

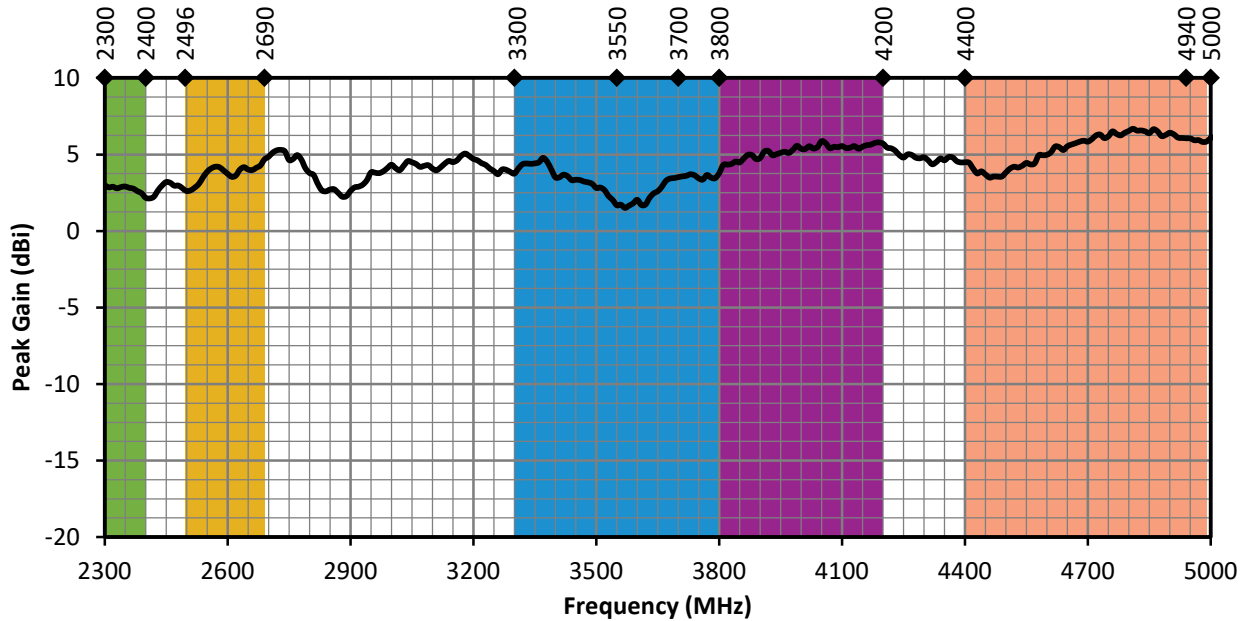

Figure 4. 5GMFPC1 Antenna Peak Gain with Frequency Band Highlights

Average Gain

Average gain (Figure 5), is the average of all antenna gain in 3-dimensional space at each frequency, providing an indication of overall performance without expressing antenna directionality.

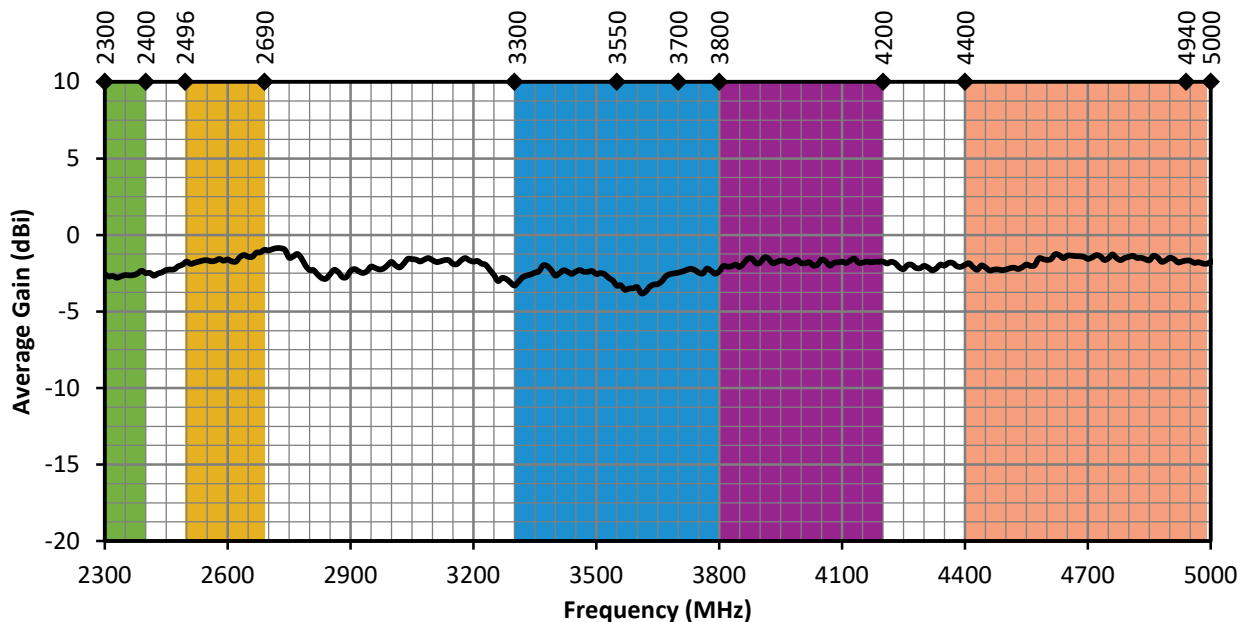

Figure 5. 5GMFPC1 Antenna Average Gain with Frequency Band Highlights

Radiation Efficiency

Radiation efficiency (Figure 6), shows the ratio of power delivered to the antenna relative to the power radiated at the antenna, expressed as a percentage, where a higher percentage indicates better performance at a given frequency.

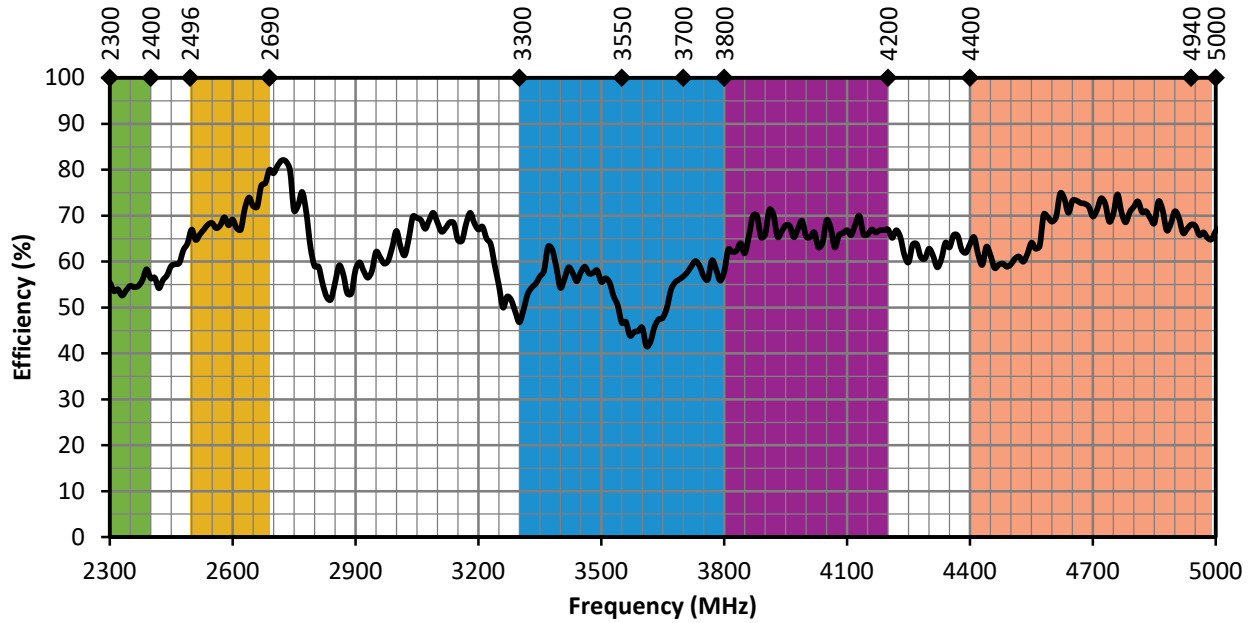
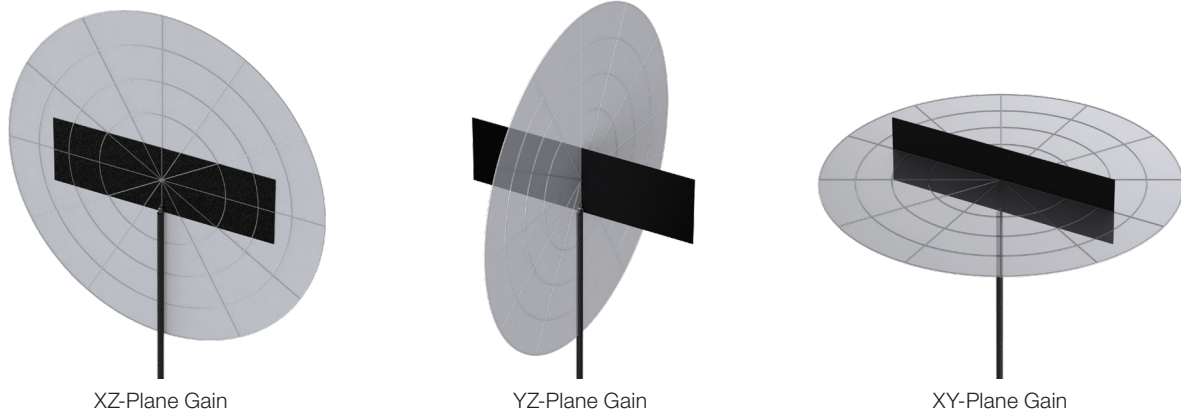

Figure 6. 5GMFPC1 Antenna Radiation Efficiency with Frequency Band Highlights

Radiation Patterns

Radiation patterns provide information about the directionality and 3-dimensional gain performance of the antenna by plotting gain at specific frequencies in three orthogonal planes. Antenna radiation patterns (Figure 7), are shown using polar plots covering 360 degrees. The antenna graphic above the plots provides reference to the plane of the column of plots below it. Note: when viewed with typical PDF viewing software, zooming into radiation patterns is possible to reveal fine detail.



2300 MHz to 2400 MHz (2350 MHz)

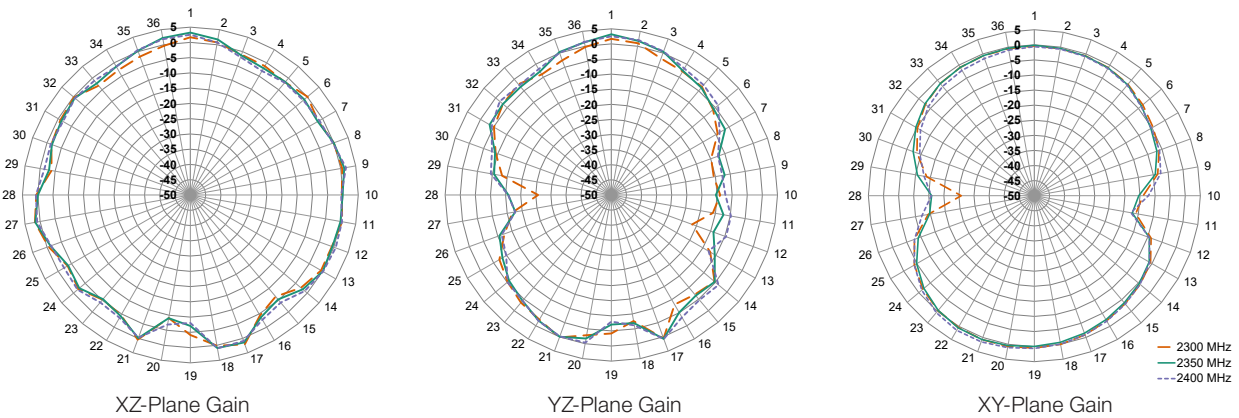

2496 MHz to 2690 MHz (2600 MHz)

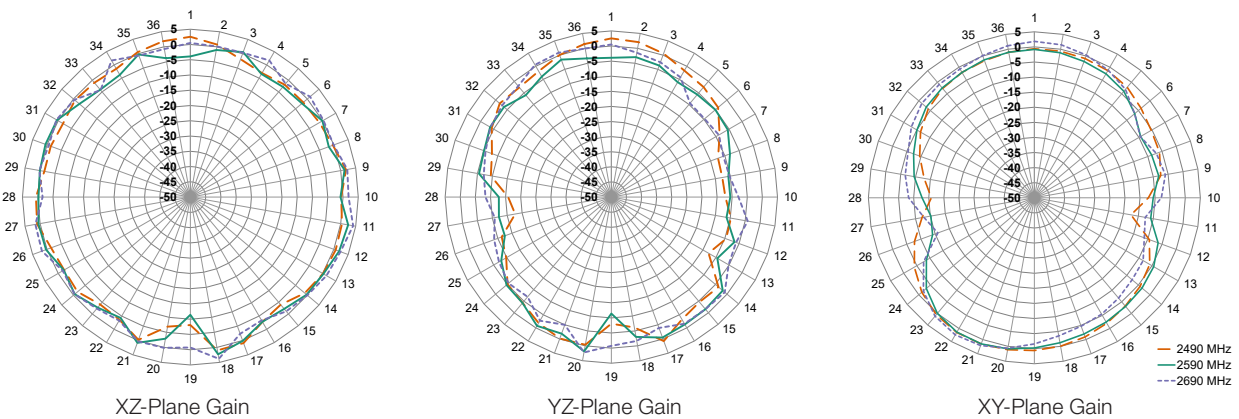

Radiation Patterns

3300 MHz to 3800 MHz (3550 MHz)

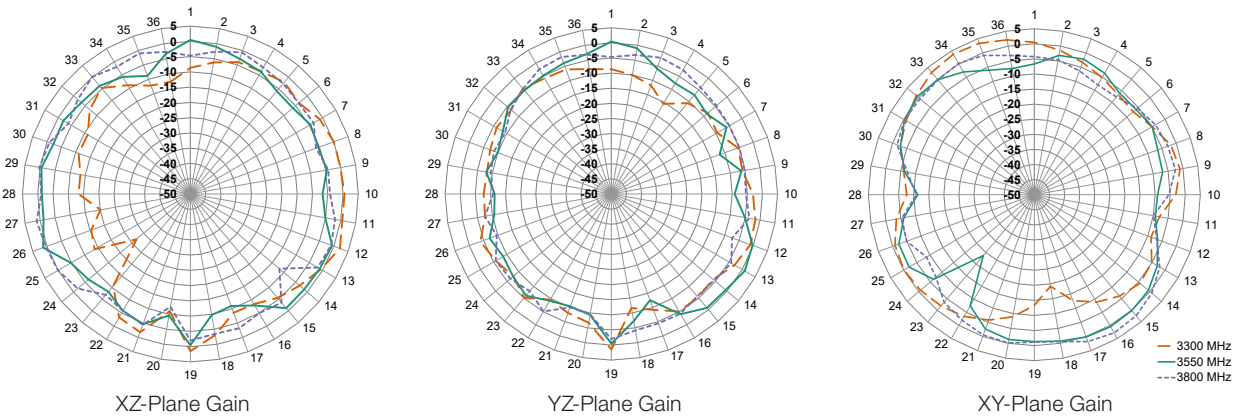

3700 MHz to 4200 MHz (3950 MHz)

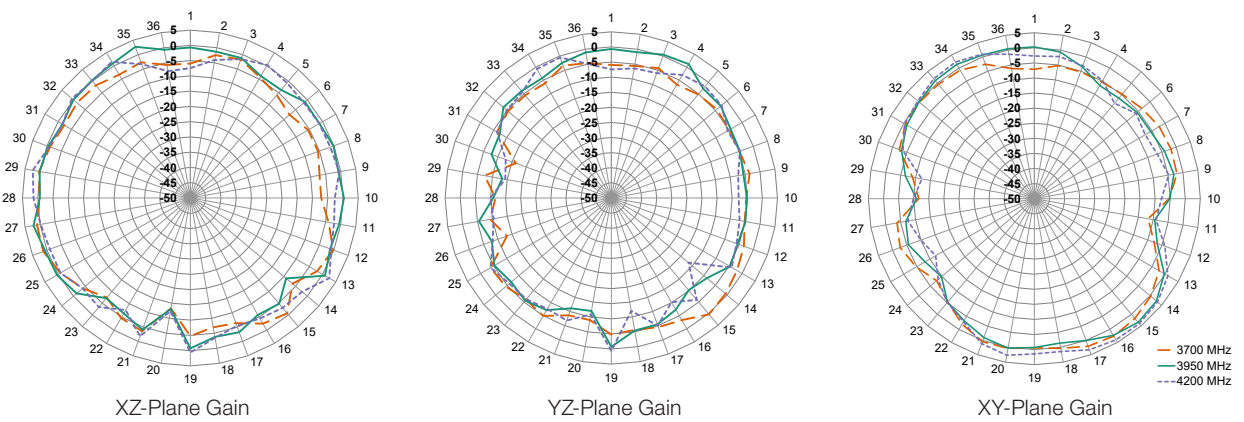

4400 MHz to 5000 MHz (4700 MHz)

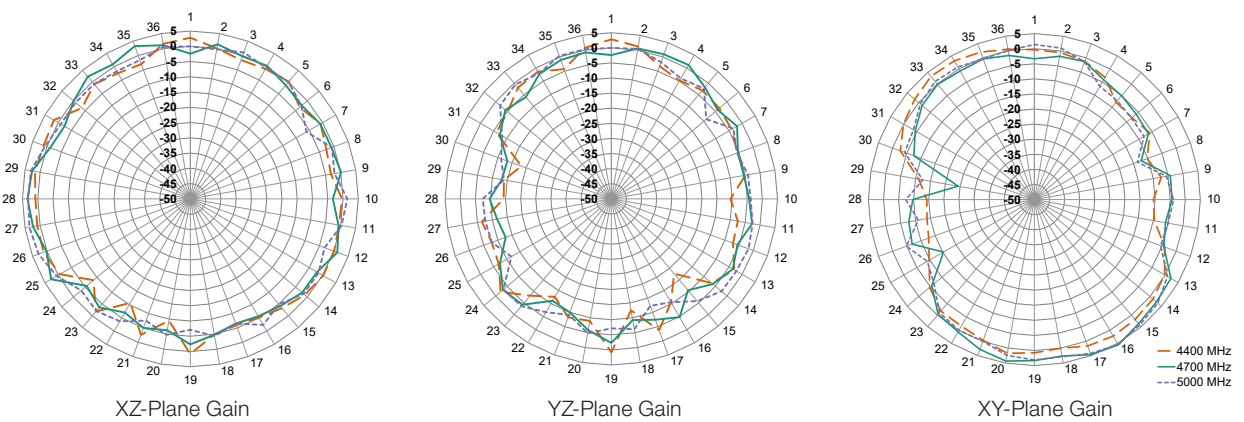

Figure 7. Radiation Patterns for ANT-5GMFPC1-UFL-100 Antenna

Packaging Information

The ANT-5GMFPC1-UFL-100 antennas are packed in a clear bag of 100 pcs. Distribution channels may offer alternative packaging options.

Website: <http://linxtechnologies.com>
Linx Offices: 159 Ort Lane, Merlin, OR, US 97532
Phone: +1 (541) 471-6256
E-MAIL: info@linxtechnologies.com

Linx Technologies reserves the right to make changes to the product(s) or information contained herein without notice. No liability is assumed as a result of their use or application. No rights under any patent accompany the sale of any such product(s) or information.

Wireless Made Simple is a registered trademark of Linx Acquisitions LLC. Other product and brand names may be trademarks or registered trademarks of their respective owners.

Copyright © 2020 Linx Technologies

All Rights Reserved

Doc# DS20262-103ANT

