

LMV710, LMV711 and LMV715

Low Power, RRIO Operational Amplifiers with High Output Current Drive and Shutdown Option

General Description

The LMV710, LMV711 and LMV715 are BiCMOS operational amplifiers with a CMOS input stage. These devices have greater than RR input common mode voltage range, rail-to-rail output and high output current drive. They offer a bandwidth of 5MHz and a slew rate of 5V/μs.

On the LMV711/LMV715, a separate shutdown pin can be used to disable the device and reduces the supply current to 0.2μA (typical). They also feature a turn on time of less than 10μs. It is an ideal solution for power sensitive applications, such as cellular phone, pager, palm computer, etc. In addition, once the LMV715 is in shutdown the output will be "Tri-stated".

The LMV710 is offered in the space saving SOT23-5 Tiny package. The LMV711 and LMV715 are offered in the space saving SOT23-6 Tiny package.

The LMV710/711/715 are designed to meet the demands of low power, low cost, and small size required by cellular phones and similar battery powered portable electronics.

Features

(For 5 Supply, Typical Unless Otherwise Noted).

- Low offset voltage 3mV, max
- Gain-bandwidth product 5MHz, typ
- Slew rate 5V/μs, typ
- Space saving packages SOT23-5 and SOT23-6
- Turn on time from shutdown <10μs
- Industrial temperature range -40°C to +85°C
- Supply current in shutdown mode 0.2μA, typ
- Guaranteed 2.7V and 5V Performance
- Unity gain stable
- Rail-to-rail input and output
- Capable of driving 600Ω load

Applications

- Wireless phones
- GSM/TDMA/CDMA power amp control
- AGC, RF power detector
- Temperature compensation
- Wireless LAN
- Bluetooth
- HomeRF

Typical Application

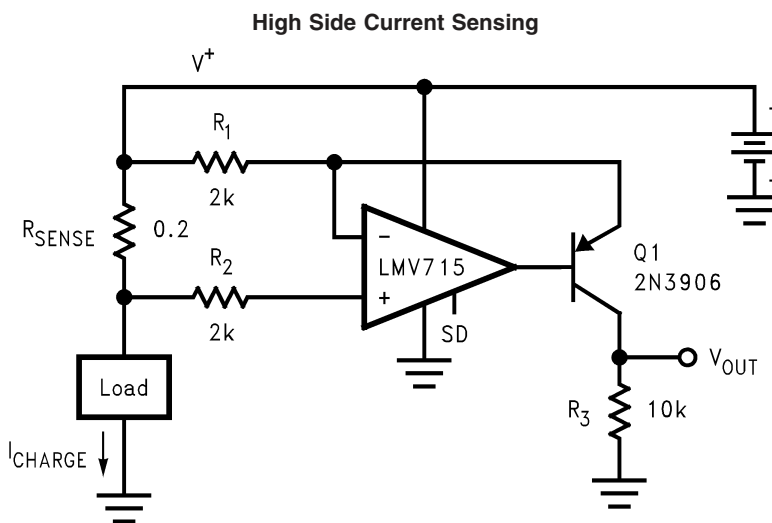

$$V_{OUT} = \frac{R_{SENSE} \cdot R_3}{R_1} \cdot I_{Charge} = 1\Omega \cdot I_{Charge}$$

10132513

Absolute Maximum Ratings (Note 1)

If Military/Aerospace specified devices are required, please contact the National Semiconductor Sales Office/Distributors for availability and specifications.

ESD Tolerance (Note 2)	
Machine Model	100V
Human Body Model	2000V
Differential Input Voltage	\pm Supply Voltage
Voltage at Input/Output Pin	(V ⁺) + 0.4V (V ⁻) - 0.4V
Supply Voltage (V ⁺ - V ⁻)	5.5V
Output Short Circuit to V ⁺	(Note 3)
Output Short Circuit to V ⁻	(Note 4)
Current at Input Pin	\pm 10mA

Mounting Temp.

Infrared or Convection (20 sec) 235°C

Storage Temperature Range -65°C to 150°C

Junction Temperature(T_{JMAX}) 150°C
(Note 5)**Operating Ratings** (Note 1)

Supply Voltage	2.7V to 5.0V
Temperature Range	-40°C ≤ T _J ≤ 85°C
Thermal Resistance (θ _{JA})	
MF05A Package, 5-Pin SOT23-5	265 °C/W
MF06A package, 6-Pin SOT23-6	265 °C/W

2.7V Electrical Characteristics

Unless otherwise specified, all limits guaranteed for T_J = 25°C. V⁺ = 2.7V, V⁻ = 0V, V_{CM} = 1.35V and R_L > 1MΩ. **Boldface** limits apply at the temperature extremes.

Symbol	Parameter	Condition	Typ (Note 6)	Limits (Note 7)	Units
V _{OS}	Input Offset Voltage	V _{CM} = 0.85V & V _{CM} = 1.85V	0.4	3 3.2	mV max
I _B	Input Bias Current		4		pA
CMRR	Common Mode Rejection Ratio	0 ≤ V _{CM} ≤ 2.7V	75	50 45	dB min
PSRR	Power Supply Rejection Ratio	2.7V ≤ V ⁺ ≤ 5V, V _{CM} = 0.85V	110	70 68	dB min
		2.7V ≤ V ⁺ ≤ 5V, V _{CM} = 1.85V	95	70 68	dB min
V _{CM}	Input Common-Mode Voltage Range	For CMRR ≥ 50dB	-0.3	-0.2	V
			3	2.9	
I _{SC}	Output Short Circuit Current	Sourcing V _O = 0V	28	15 12	mA min
		Sinking V _O = 2.7V	40	25 22	mA min
V _O	Output Swing	R _L = 10kΩ to 1.35V	2.68	2.62 2.60	V min
			0.01	0.12 0.15	V max
		R _L = 600Ω to 1.35V	2.55	2.52 2.50	V min
			0.05	0.23 0.30	V max
V _O (SD)	Output Voltage Level in Shutdown Mode (LMV711 only)		50	200	mV
I _O (SD)	Output Leakage Current in Shutdown Mode (LMV715 Only)		1		pA
C _O (SD)	Output Capacitance in Shutdown Mode (LMV715 Only)		32		pF
I _S	Supply Current	ON Mode	1.22	1.7 1.9	mA max
		Shutdown Mode, V _{SD} = 0V	0.002	10	μA

2.7V Electrical Characteristics (Continued)

Unless otherwise specified, all limits guaranteed for $T_J = 25^\circ\text{C}$. $V^+ = 2.7\text{V}$, $V^- = 0\text{V}$, $V_{\text{CM}} = 1.35\text{V}$ and $R_L > 1\text{M}\Omega$. **Boldface** limits apply at the temperature extremes.

Symbol	Parameter	Condition	Typ (Note 6)	Limits (Note 7)	Units
A_V	Large Signal Voltage	Sourcing $R_L = 10\text{k}\Omega$ $V_O = 1.35\text{V to } 2.3\text{V}$	115	80 76	dB min
		Sinking $R_L = 10\text{k}\Omega$ $V_O = 0.4\text{V to } 1.35\text{V}$	113	80 76	dB min
		Sourcing $R_L = 600\Omega$ $V_O = 1.35\text{V to } 2.2\text{V}$	110	80 76	dB min
		Sinking $R_L = 600\Omega$ $V_O = 0.5\text{V to } 1.35\text{V}$	100	80 76	dB min
SR	Slew Rate	(Note 8)	5		V/ μs
GBWP	Gain-Bandwidth Product		5		MHz
ϕ_m	Phase Margin		60		Deg
T_{ON}	Turn-on Time from Shutdown		<10		μs
V_{SD}	Shutdown Pin Voltage Range	On Mode	1.5 to 2.7	2.4 to 2.7	V
		Shutdown Mode	0 to 1	0 to 0.8	V
e_n	Input-Referred Voltage Noise	$f = 1\text{kHz}$	20		$\frac{\text{nV}}{\sqrt{\text{Hz}}}$

3.2V Electrical Characteristics

Unless otherwise specified, all limits guaranteed for $T_J = 25^\circ\text{C}$. $V^+ = 3.2\text{V}$, $V^- = 0\text{V}$, $V_{\text{CM}} = 1.6\text{V}$. **Boldface** limits apply at the temperature extremes.

Symbol	Parameter	Conditions	Typ (Note 6)	Limit (Note 7)	Units
V_O	Output Swing	$I_O = 6.5\text{mA}$	3.0	2.95 2.92	V min
			0.01	0.18 0.25	V max

5V Electrical Characteristics

Unless otherwise specified, all limits guaranteed for $T_J = 25^\circ\text{C}$. $V^+ = 5\text{V}$, $V^- = 0\text{V}$, $V_{\text{CM}} = 2.5\text{V}$, and $R_L > 1\text{M}\Omega$. **Boldface** limits apply at the temperature extremes.

Symbol	Parameter	Condition	Typ (Note 6)	Limits (Note 7)	Units
V_{OS}	Input Offset Voltage	$V_{\text{CM}} = 0.85\text{V} \ \& \ V_{\text{CM}} = 1.85\text{V}$	0.4	3 3.2	mV max
I_B	Input Bias Current		4		pA
CMRR	Common Mode Rejection Ratio	$0\text{V} \leq V_{\text{CM}} \leq 5\text{V}$	70	50 48	dB min
PSRR	Power Supply Rejection Ratio	$2.7\text{V} \leq V^+ \leq 5\text{V}$, $V_{\text{CM}} = 0.85\text{V}$	110	70 68	dB min
		$2.7\text{V} \leq V^+ \leq 5\text{V}$, $V_{\text{CM}} = 1.85\text{V}$	95	70 68	dB min
V_{CM}	Input Common-Mode Voltage Range	For CMRR $\geq 50\text{dB}$	-0.3	-0.2	V
			5.3	5.2	

5V Electrical Characteristics (Continued)

Unless otherwise specified, all limits guaranteed for $T_J = 25^\circ\text{C}$. $V^+ = 5\text{V}$, $V^- = 0\text{V}$, $V_{\text{CM}} = 2.5\text{V}$, and $R_L > 1\text{M}\Omega$. **Boldface** limits apply at the temperature extremes.

Symbol	Parameter	Condition	Typ (Note 6)	Limits (Note 7)	Units
I_{SC}	Output Short Circuit Current	Sourcing $V_O = 0\text{V}$	35	25 21	mA min
		Sinking $V_O = 5\text{V}$	40	25 21	mA min
V_O	Output Swing	$R_L = 10\text{k}\Omega$ to 2.5V	4.98	4.92 4.90	V min
			0.01	0.12 0.15	V max
		$R_L = 600\Omega$ to 2.5V	4.85	4.82 4.80	V min
			0.05	0.23 0.3	V max
V_O (SD)	Output Voltage Level in Shutdown Mode (LMV711 only)		50	200	mV
I_O (SD)	Output Leakage Current in Shutdown Mode (LMV715 Only)		1		pA
C_O (SD)	Output Capacitance in shutdown Mode (LMV715 Only)		32		pF
I_S	Supply Current	On Mode	1.17	1.7 1.9	mA max
		Shutdown Mode	0.2	10	μA
A_V	Large Signal Voltage Gain	Sourcing $R_L = 10\text{k}\Omega$ $V_O = 2.5\text{V}$ to 4.6V	123	80 76	dB min
		Sinking $R_L = 10\text{k}\Omega$ $V_O = 0.4\text{V}$ to 2.5V	120	80 76	dB min
		Sourcing $R_L = 600\Omega$ $V_O = 2.5\text{V}$ to 4.5V	110	80 76	dB min
		Sinking $R_L = 600\Omega$ $V_O = 0.5\text{V}$ to 2.5V	118	80 76	dB min
SR	Slew Rate	(Note 8)	5		V/ μs
GBWP	Gain-Bandwidth Product		5		MHz
ϕ_m	Phase Margin		60		Deg
T_{ON}	Turn-on Time from Shutdown		<10		μs
V_{SD}	Shutdown Pin Voltage Range	ON Mode	2 to 5	2.4 to 5	V
		Shutdown Mode	0 to 1.5	0 to 0.8	
e_n	Input-Referred Voltage Noise	$f = 1\text{kHz}$	20		$\frac{\text{nV}}{\sqrt{\text{Hz}}}$

Note 1: Absolute Maximum Ratings indicate limits beyond which damage to the device may occur. Operating Ratings indicate conditions for which the device is intended to be functional, but specific performance is not guaranteed. For guaranteed specifications and the test conditions, see the Electrical Characteristics.

Note 2: Human body model, 1.5 k Ω in series with 100pF. Machine model, 0 Ω in series with 100pF.

Note 3: Shorting circuit output to V^+ will adversely affect reliability.

Note 4: Shorting circuit output to V^- will adversely affect reliability.

Note 5: The maximum power dissipation is a function of $T_{\text{J(max)}}$, θ_{JA} , and T_A . The maximum allowable power dissipation at any ambient temperature is $P_D = (T_{\text{J(max)}} - T_A)/\theta_{\text{JA}}$. All numbers apply for packages soldered directly into a PC board.

Note 6: Typical values represent the most likely parametric norm.

Note 7: All limits are guaranteed by testing or statistical analysis.

Note 8: Number specified is the slower of the positive and negative slew rates.

Typical Performance Characteristics

Unless otherwise specified, $V_S = +5V$, single supply,

$T_A = 25^\circ C$.

Supply Current vs. Supply Voltage (On Mode)

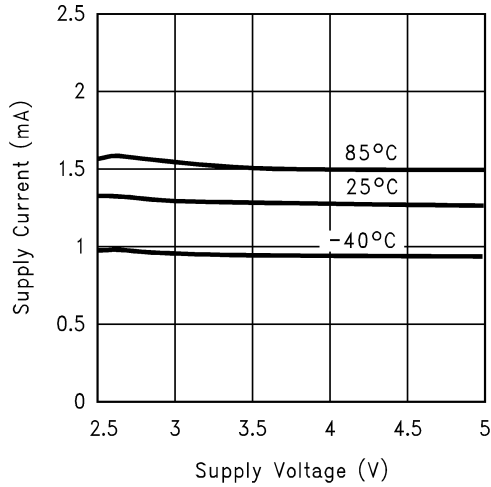

10132527

LMV711 and LMV715 Supply Current vs. Supply Voltage (Shutdown Mode)

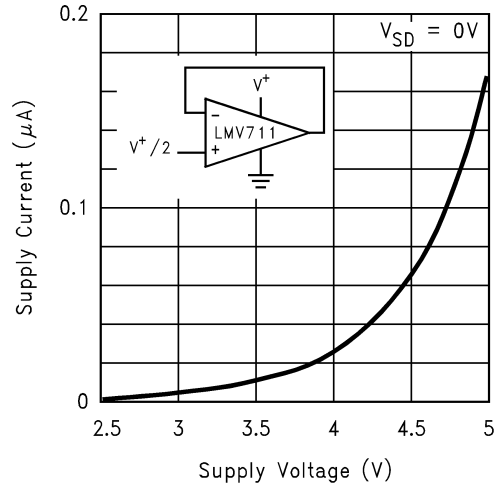

10132528

Output Positive Swing vs. Supply Voltage

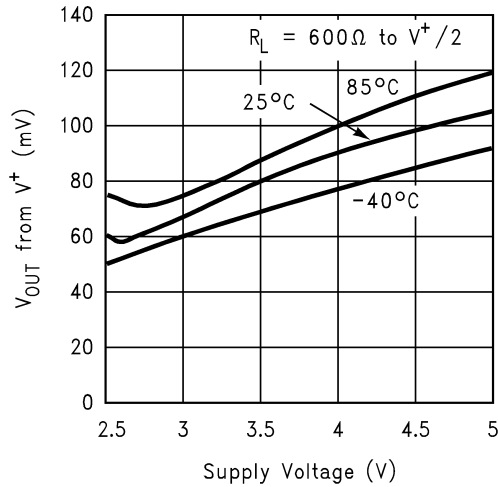

10132529

Output Negative Swing vs. Supply Voltage

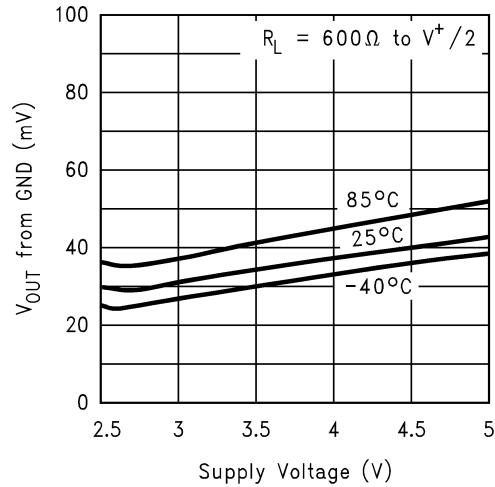

10132530

Output Positive Swing vs. Supply Voltage

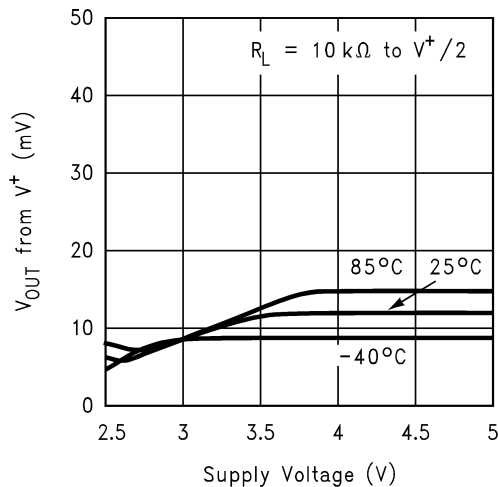

10132531

Output Negative Swing vs. Supply Voltage

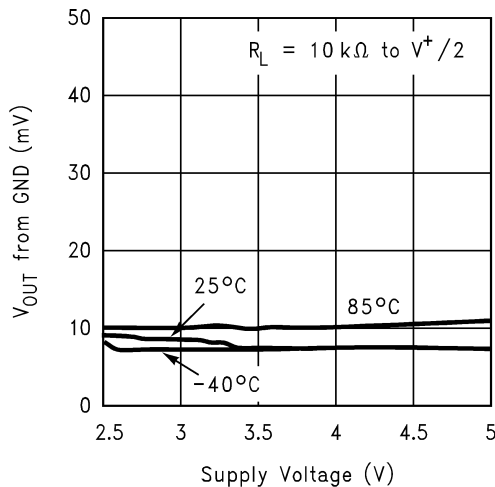

10132532

Typical Performance Characteristics Unless otherwise specified, $V_S = +5V$, single supply, $T_A = 25^\circ C$. (Continued)

Output Positive Swing vs. Supply Voltage

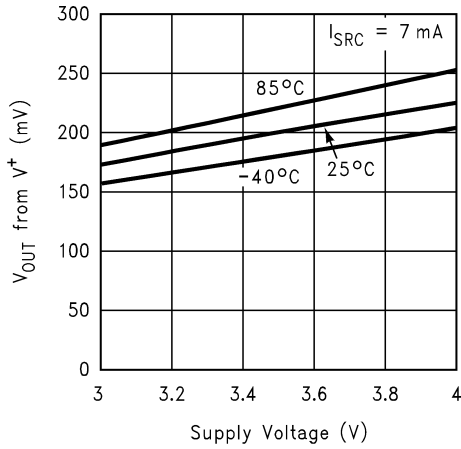

Output Negative Swing vs. Supply Voltage

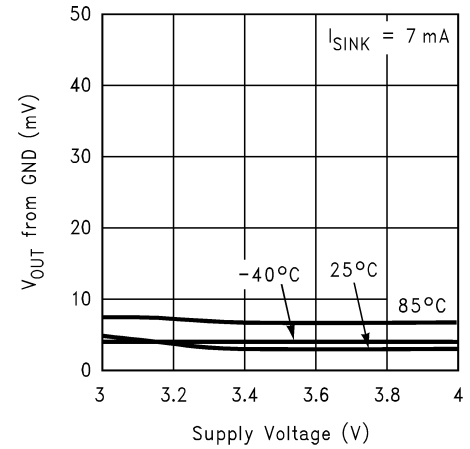

Input Voltage Noise vs. Frequency

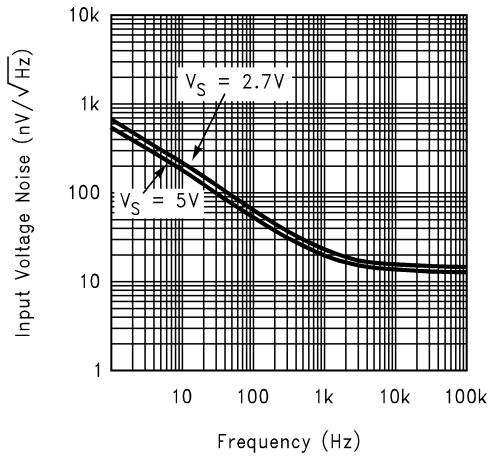

PSRR vs. Frequency

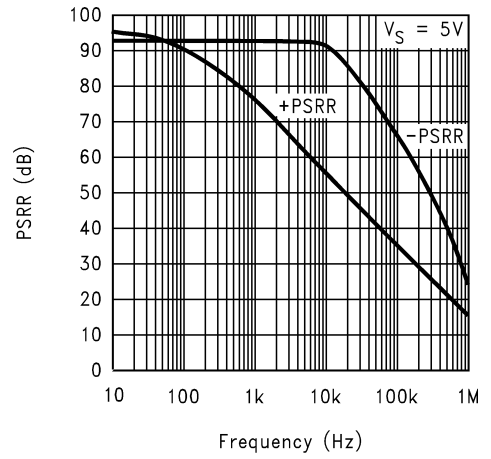

CMRR vs. Frequency

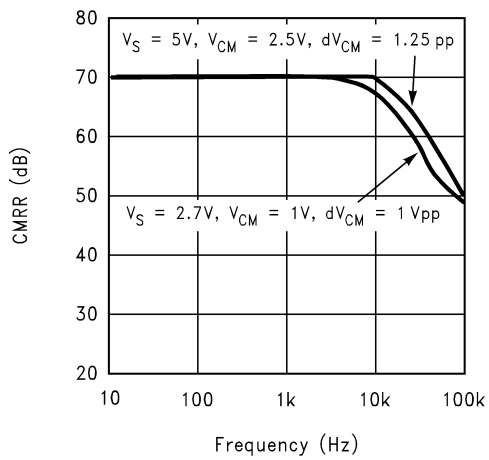

LMV711/LMV715 Turn On Characteristics

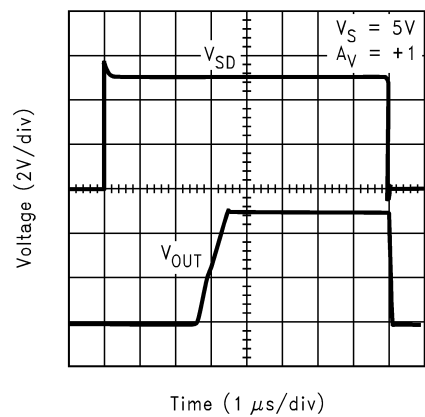

Typical Performance Characteristics Unless otherwise specified, $V_S = +5V$, single supply, $T_A = 25^\circ C$. (Continued)

Sourcing Current vs. Output Voltage

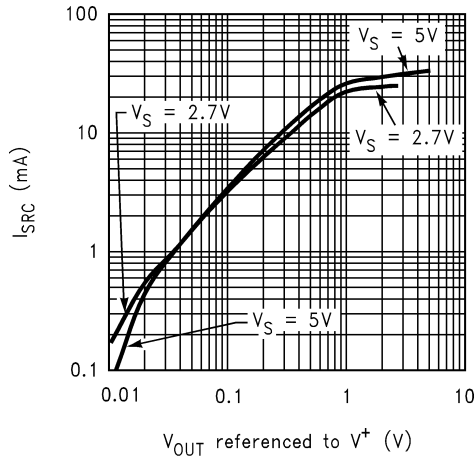

Sinking Current vs. Output Voltage

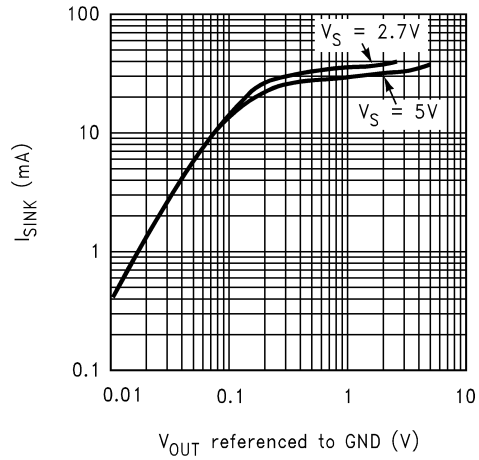

THD+N vs. Frequency ($V_S = 5V$)

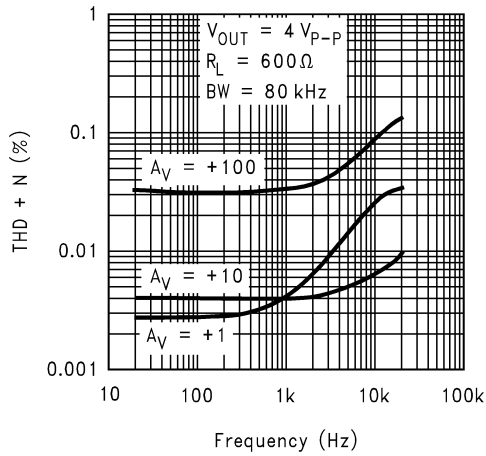

THD+N vs. Frequency ($V_S = 2.7V$)

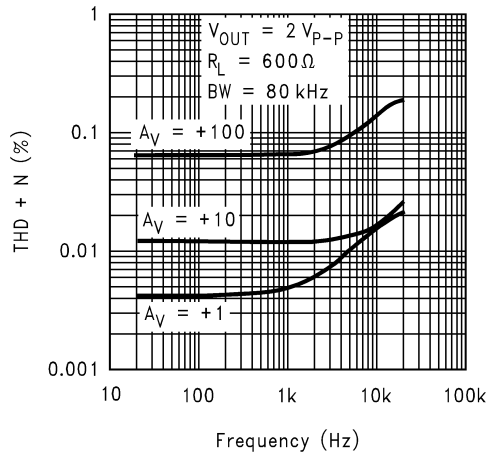

THD+N vs. V_{OUT}

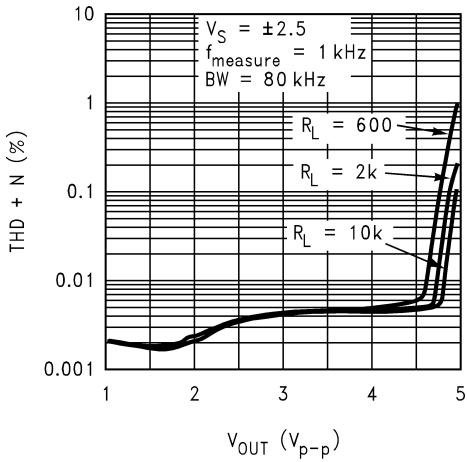

THD+N vs. V_{OUT}

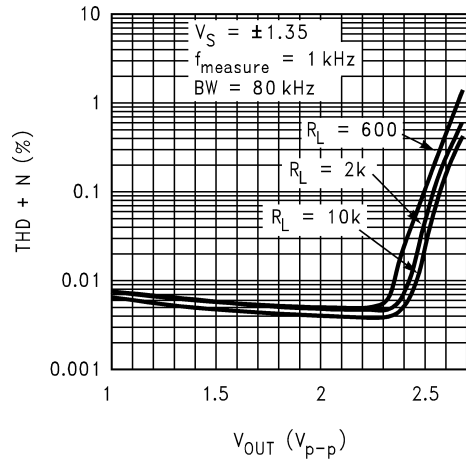

Typical Performance Characteristics Unless otherwise specified, $V_S = +5V$, single supply, $T_A = 25^\circ C$. (Continued)

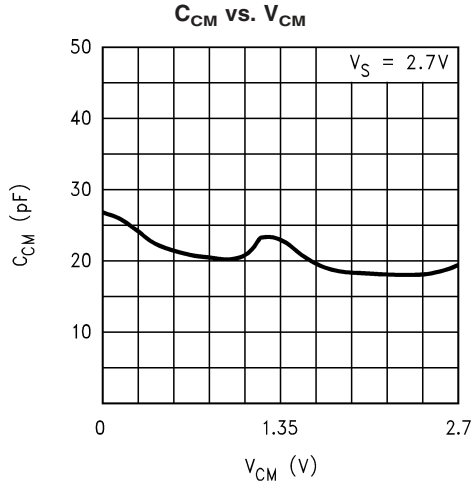

10132545

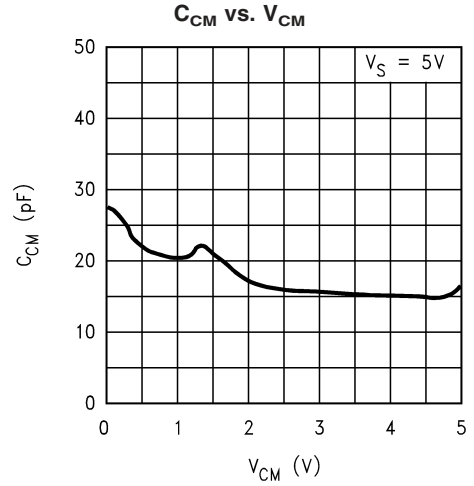

10132546

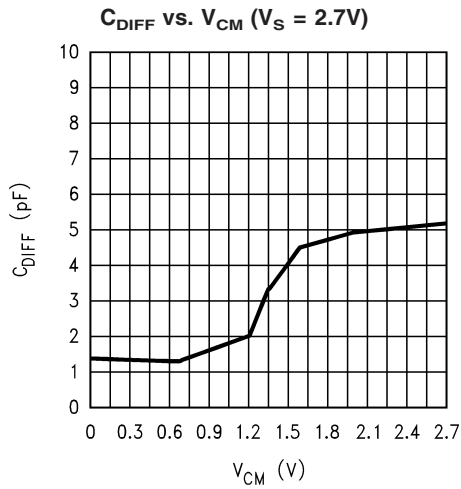

10132547

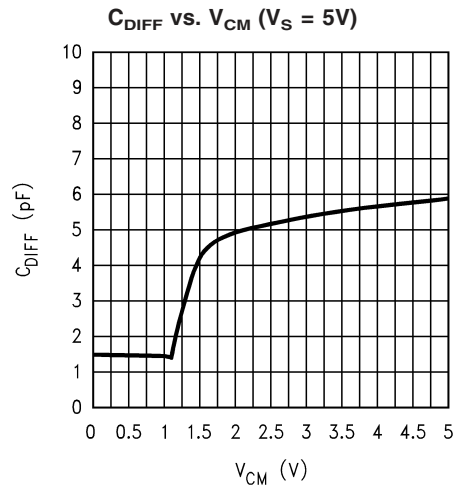

10132548

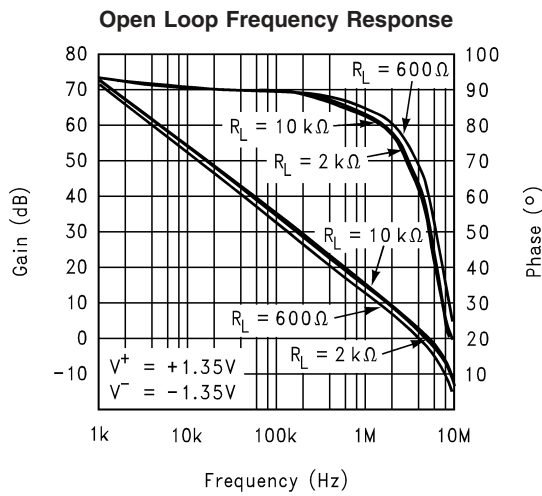

10132512

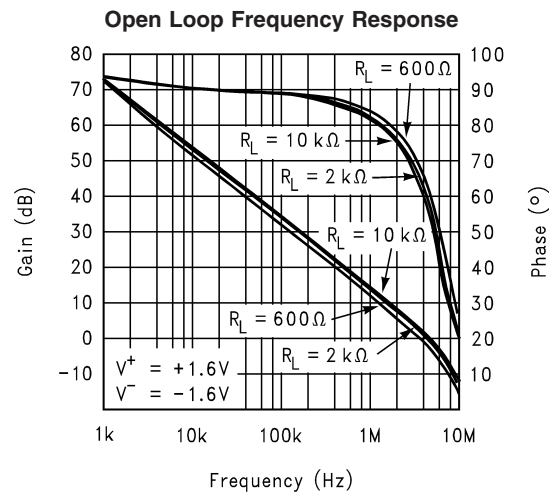

10132510

Typical Performance Characteristics Unless otherwise specified, $V_S = +5V$, single supply, $T_A = 25^\circ C$. (Continued)

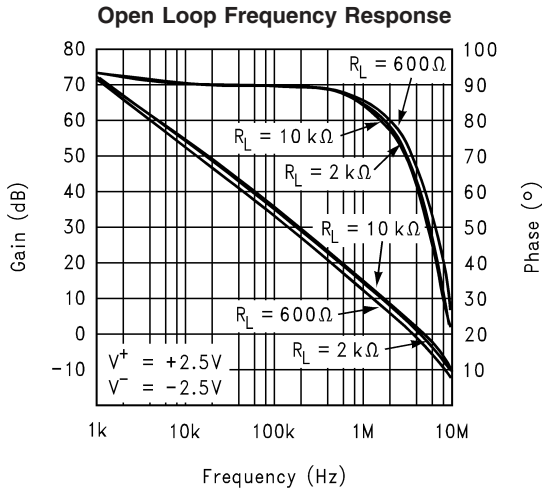

10132511

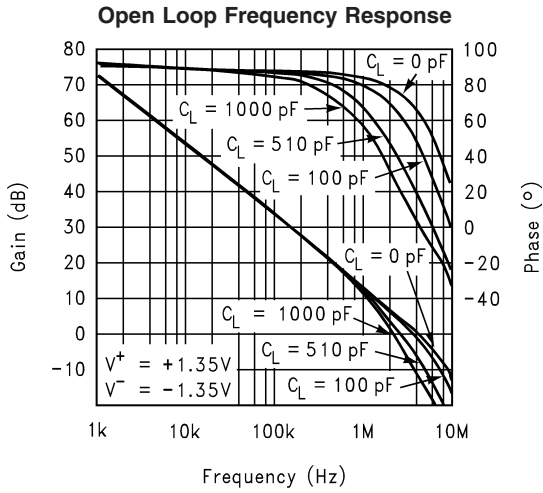

10132507

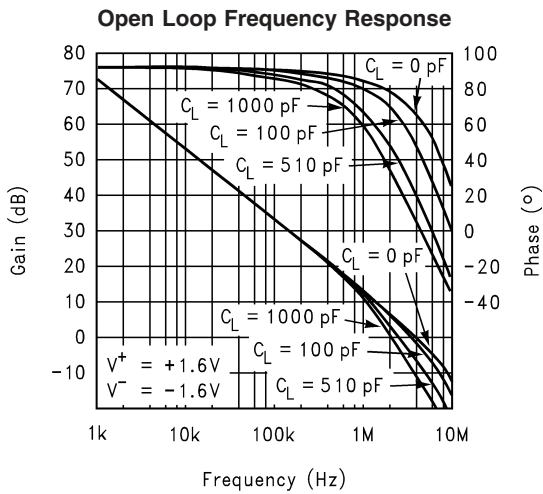

10132509

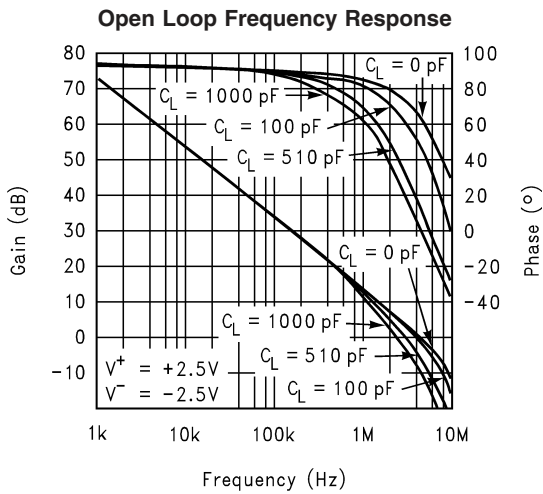

10132508

Non-Inverting Large Signal Pulse Response

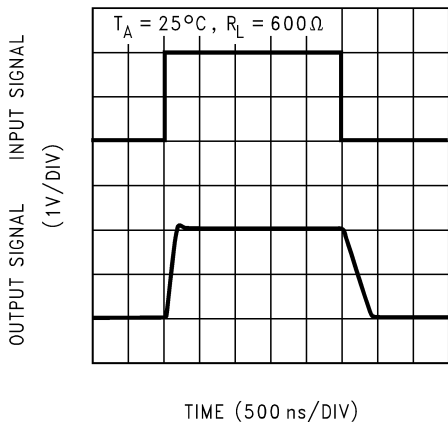

10132503

Non-Inverting Small Signal Pulse Response

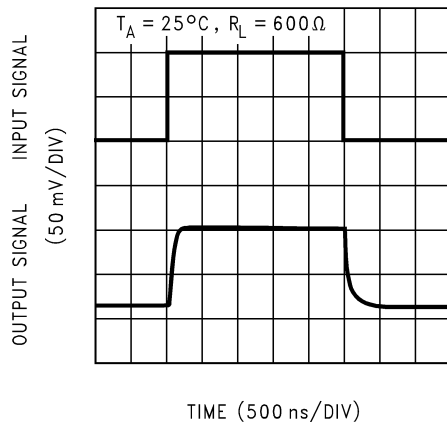

10132502

Typical Performance Characteristics Unless otherwise specified, $V_S = +5V$, single supply, $T_A = 25^\circ C$. (Continued)

Inverting Large Signal Pulse Response

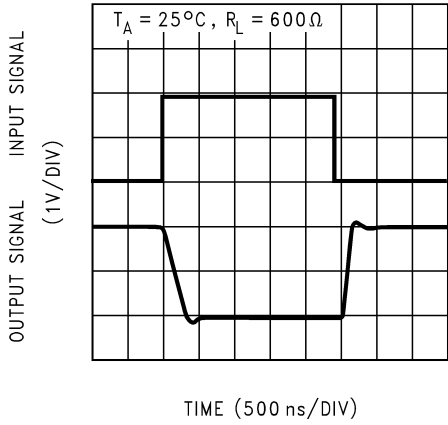

10132504

Inverting Small Signal Pulse Response

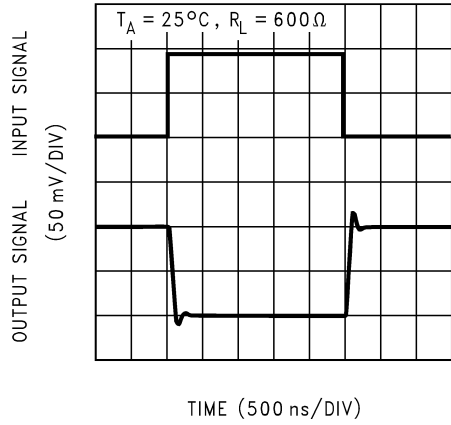

10132505

V_{OS} vs. V_{CM}

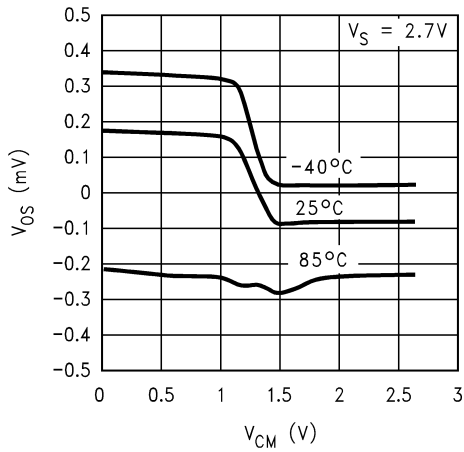

10132549

V_{OS} vs. V_{CM}

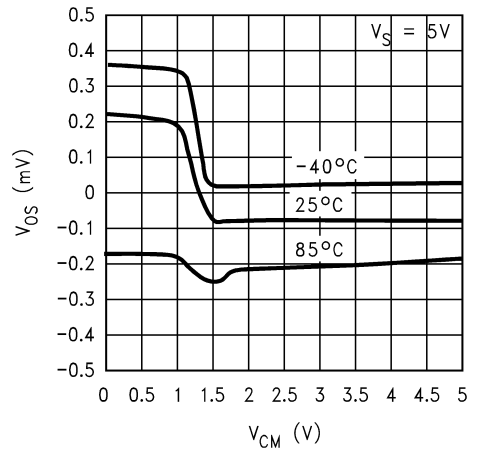

10132550

Application Note

1.0 SUPPLY BYPASSING

The application circuits in this datasheet do not show the power supply connections and the associated bypass capacitors for simplification. When the circuits are built, it is always required to have bypass capacitors. Ceramic disc capacitors (0.1 μ F) or solid tantalum (1 μ F) with short leads, and located close to the IC are usually necessary to prevent interstage coupling through the power supply internal impedance. Inadequate bypassing will manifest itself by a low frequency oscillation or by high frequency instabilities. Sometimes, a 10 μ F (or larger) capacitor is used to absorb low frequency variations and a smaller 0.1 μ F disc is paralleled across it to prevent any high frequency feedback through the power supply lines.

2.0 SHUTDOWN MODE

The LMV711 and LMV715 have a shutdown pin. To conserve battery life in portable applications, they can be disabled when the shutdown pin voltage is pulled low. For LMV711 during shutdown mode, the output stays at about 50mV from the lower rail, and the current drawn from the power supply is 0.2 μ A (typical). This makes the LMV711 an ideal solution for power sensitive applications. For the LMV715 during shutdown mode, the output will be "Tri-stated".

The shutdown pin should never be left unconnected. In applications where shutdown operation is not needed and the LMV711 or LMV715 is used, the shutdown pin should be connected to V^+ . Leaving the shutdown pin floating will result in an undefined operation mode and the device may oscillate between shutdown and active modes.

3.0 RAIL-TO-RAIL INPUT

The rail-to-rail input is achieved by using paralleled PMOS and NMOS differential input stages. (See Simplified Schematics in this datasheet). When the common mode input voltage changes from ground to the positive rail, the input stage goes through three modes. First, the NMOS pair is cutoff and the PMOS pair is active. At around 1.4V, both PMOS and NMOS pairs operate, and finally the PMOS pair is cutoff and NMOS pair is active. Since both input stages have their own offset voltage (V_{OS}), the offset of the amplifier becomes a function of the common-mode input voltage. See curves for V_{OS} vs. V_{CM} in curve section.

As shown in the curve, the V_{OS} has a crossover point at 1.4V above V^- . Proper design must be done in both DC and AC coupled applications to avoid problems. For large input signals that include the V_{OS} crossover point in their dynamic range, it will cause distortion in the output signal. One way to avoid such distortion is to keep the signal away from the crossover point. For example, in a unity gain buffer configuration and with $V_S = 5V$, a 3V peak-to-peak signal center at 2.5V will contain input-crossover distortion. To avoid this, the input signal should be centered at 3.5V instead. Another way to avoid large signal distortion is to use a gain of -1 circuit which avoids any voltage excursions at the input terminals of the amplifier. See *Figure 1*. In this circuit, the common mode DC voltage (V_{CM}) can be set at a level away from the V_{OS} crossover point.

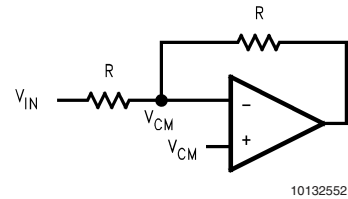

FIGURE 1.

When the input is a small signal and this small signal falls inside the V_{OS} transition range, the gain, CMRR and some other parameters will be degraded. To resolve this problem, the small signal should be placed such that it avoids the V_{OS} crossover point.

To achieve maximum output swing, the output should be biased at mid-supply. This is normally done by biasing the input at mid-supply. But with supply voltage range from 2V to 3.4V, the input of the op amp should not be biased at mid-supply because of the transition of the V_{OS} . *Figure 2* shows an example of how to get away from the V_{OS} crossover point and maintain a maximum swing with a 2.7V supply. *Figure 3* shows the waveforms of V_{IN} and V_{OUT} .

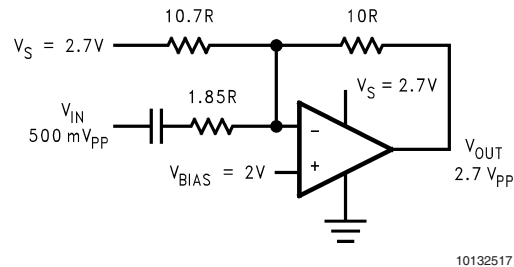

FIGURE 2.

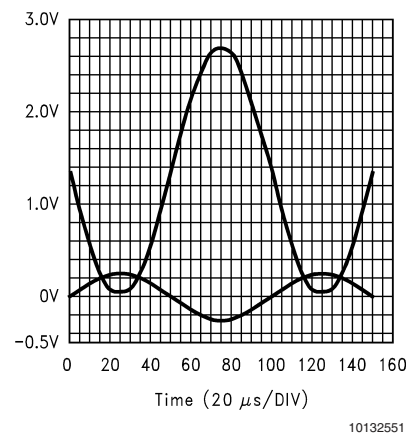

FIGURE 3.

The inputs can be driven 300mV beyond the supply rails without causing phase reversal at the output. However, the inputs should not be allowed to exceed the maximum ratings.

Application Note (Continued)

4.0 COMPENSATION OF INPUT CAPACITANCE

In the application (*Figure 4*) where a large feedback resistor is used, the feedback resistor can react with the input capacitance of the op amp and introduce an additional pole to the close loop frequency response.

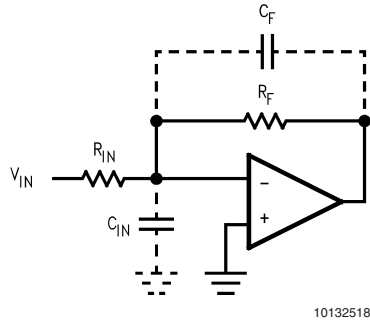

FIGURE 4. Cancelling the Effect of Input Capacitance

This pole occurs at frequency f_p , where

$$f_p = \frac{1}{2\pi(R_{IN} \parallel R_F)C_{IN}}$$

Any stray capacitance due to external circuit board layout, any source capacitance from transducer or photodiode connected to the summing node will also be added to the input capacitance. If f_p is less than or close to the unity-gain bandwidth (5MHz) of the op amp, the phase margin of the loop is reduced and can cause the system to be unstable.

To avoid this problem, make sure that f_p occurs at least 2 octaves beyond the expected -3dB frequency corner of the close loop frequency response. If not, a feedback capacitor C_F can be placed in parallel with R_F such that

$$\frac{1}{2\pi R_F C_F} = \frac{1}{2\pi(R_{IN} \parallel R_F)(C_F + C_{IN})}$$

The paralleled R_F and C_F introduce a zero, which cancels the effect from the pole.

5.0 CAPACITIVE LOAD TOLERANCE

The LMV710, LMV711 and LMV715 can directly drive 200pF in unity-gain without oscillation. The unity-gain follower is the most sensitive configuration to capacitive loading. Direct capacitive loading reduces the phase margin of amplifiers. The combination of the amplifier's output impedance and the capacitive load induces phase lag. This results in either an underdamped pulse response or oscillation. To drive a heavier capacitive load, circuit in *Figure 5* can be used.

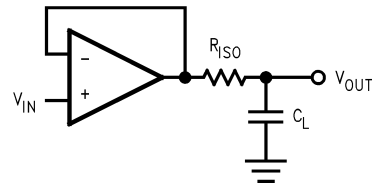

FIGURE 5. Indirectly Driving A Capacitive Load using Resistive Isolation

In *Figure 5*, the isolation resistor R_{ISO} and the load capacitor C_L form a pole to increase stability by adding more phase margin to the overall system. The desired performance depends on the value of R_{ISO} . The bigger the R_{ISO} resistor value, the more stable V_{OUT} will be. But the DC accuracy is not great when the R_{ISO} gets bigger. If there were a load resistor in *Figure 5*, the output would be voltage divided by R_{ISO} and the load resistor.

The circuit in *Figure 6* is an improvement to the one in *Figure 5* because it provides DC accuracy as well as AC stability. In this circuit, R_F provides the DC accuracy by using feed-forward techniques to connect V_{IN} to R_L . C_F and R_{ISO} serve to counteract the loss of phase margin by feeding the high frequency component of the output signal back to the amplifier's inverting input, thereby preserving phase margin in the overall feedback loop. Increased capacitive drive is possible by increasing the value of C_F . This in turn will slow down the pulse response.

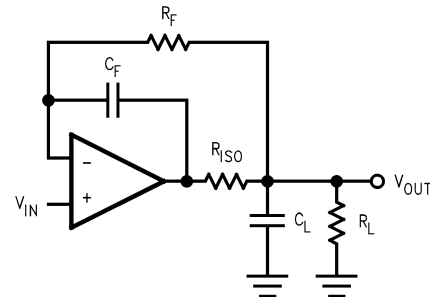

FIGURE 6. Indirectly Driving A Capacitive A Load with DC Accuracy

6.0 APPLICATION CIRCUITS PEAK DETECTOR

Peak detectors are used in many applications, such as test equipment, measurement instrumentation, ultrasonic alarm systems, etc. *Figure 7* shows the schematic diagram of a peak detector using LMV710 or LMV711 or LMV715. This peak detector basically consists of a clipper, a parallel RC network, and a voltage follower.

Application Note (Continued)

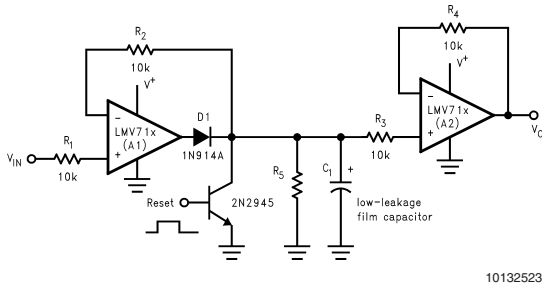

FIGURE 7. Peak Detector

The capacitor C_1 is first discharged by applying a positive pulse to the reset transistor. When a positive voltage V_{IN} is applied to the input, the input voltage is higher than the voltage across C_1 . The output of the op amp goes high and forward biases the diode D_1 . The capacitor C_1 is charged to V_{IN} . When the input becomes less than the current capacitor voltage, the output of the op amp A_1 goes low and the diode D_1 is reverse biased. This isolates the C_1 and leaves it with the charge equivalent to the peak of the input voltage. The follower prevents unintentional discharging of C_1 by loading from the following circuit.

R_5 and C_1 are properly selected so that the capacitor is charged rapidly to V_{IN} . During the holding period, the capacitor slowly discharge through C_1 , via leakage of the capacitor and the reverse-biased diode, or op amp bias currents. In any cases the discharging time constant is much larger than the charge time constant. And the capacitor can hold its voltage long enough to minimize the output ripple.

Resistors R_2 and R_3 limit the current into the inverting input of A_1 and the non-inverting input of A_2 when power is disconnected from the circuit. The discharging current from C_1 during power off may damage the input circuitry of the op amps.

The peak detector can be reset by applying a positive pulse to the reset transistor. The charge on the capacitor is dumped into ground, and the detector is ready for another cycle.

The maximum input voltage to this detector should be less than $(V^+ - V_D)$, where V_D is the forward voltage drop of the diode. Otherwise, the input voltage should be scaled down before applying to the circuit.

HIGH SIDE CURRENT SENSING

The high side current sensing circuit (*Figure 8*) is commonly used in a battery charger to monitor charging current to prevent over-charging. A sense resistor R_{sense} is connected to the battery directly. This system requires an op amp with rail-to-rail input. The LMV710/711/715 are ideal for this application because its common mode input range can go beyond the positive rail.

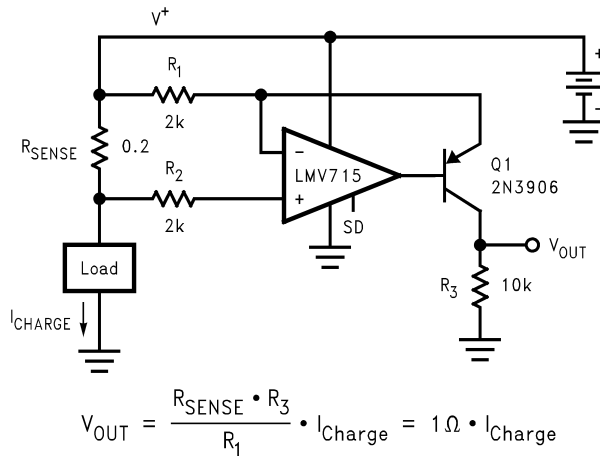

$$V_{OUT} = \frac{R_{SENSE} \cdot R_3}{R_1} \cdot I_{CHARGE} = 1 \Omega \cdot I_{CHARGE}$$

10132513

FIGURE 8. High Side Current Sensing

Simplified Schematic

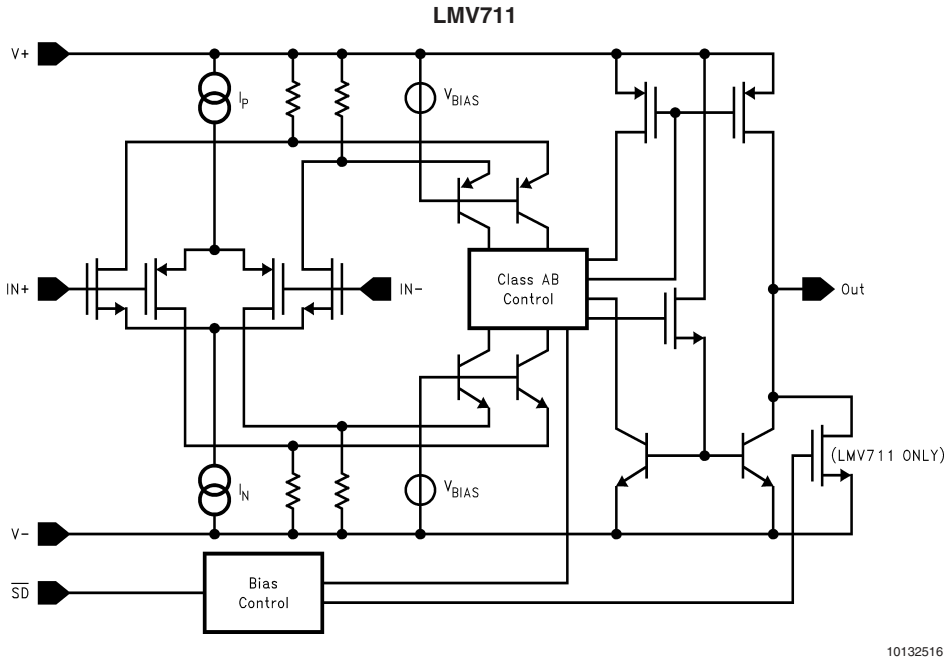

Connection Diagrams

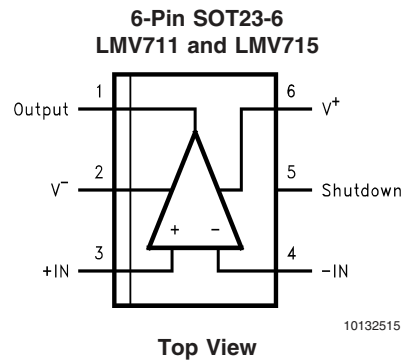
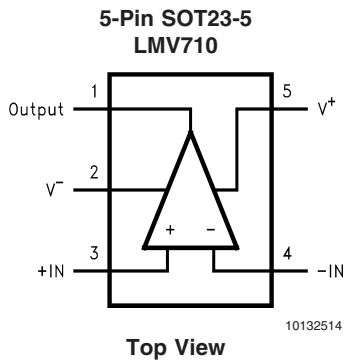

Ordering Information

Package	Temperature Range Industrial -40°C to +85°C	Packaging Marking	Transport Media	NSC Drawing
5-Pin SOT23-5	LMV710M5	A48A	1k Units Tape and Reel	MF05A
	LMV710M5X		3k Units Tape and Reel	
6-Pin SOT23-6	LMV711M6	A47A	1k Units Tape and Reel	MF06A
	LMV711M6X		3k Units Tape and Reel	
	LMV715MF	A75A	1k Units Tape and Reel	
	LMV715MFX		3k Units Tape and Reel	

SOT-23 Tape and Reel Specification

Tape Format

Tape Section	# Cavities	Cavity Status	Cover Tape Status
Leader (Start End)	0 (min)	Empty	Sealed
	75 (min)	Empty	Sealed
Carrier	3000	Filled	Sealed
	1000	Filled	Sealed
Trailer (Hub End)	125 (min)	Empty	Sealed
	0 (min)	Empty	Sealed

Tape Dimensions

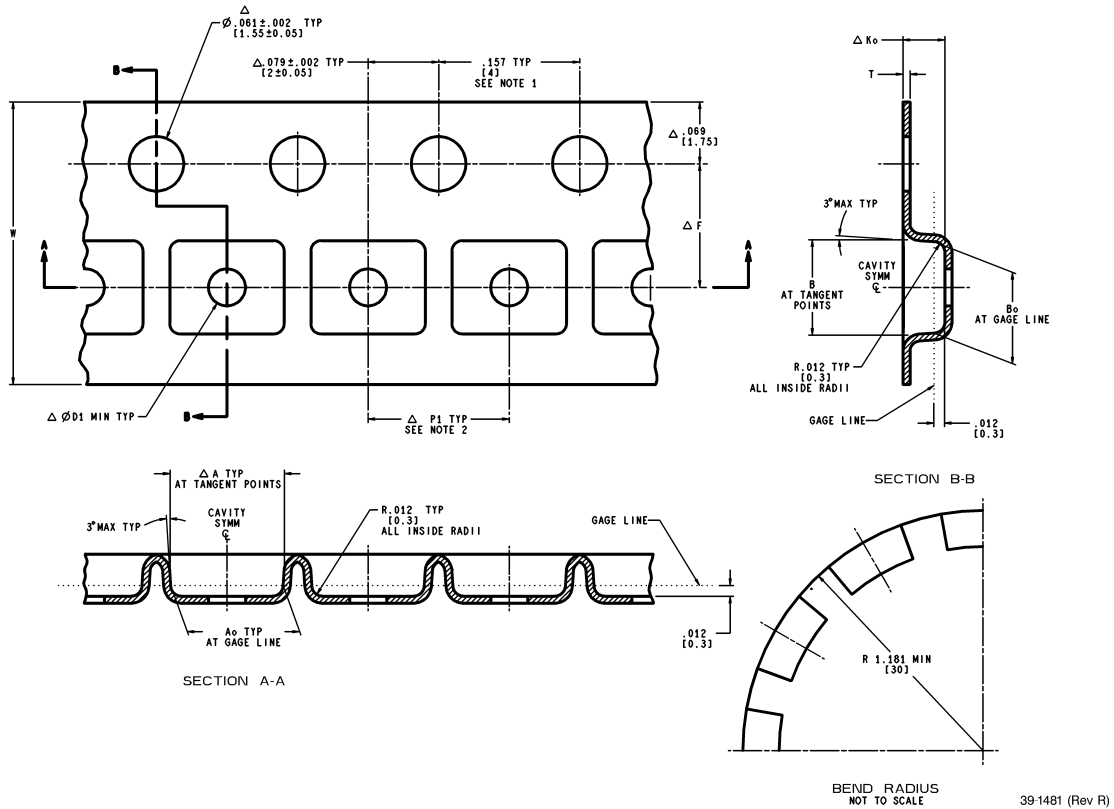

39-1481 (Rev R)

10132555

TAPE SIZE	DIM A	DIM A _o	DIM B	DIM B _o	DIM F	DIM K _o	DIM P1	DIM T	DIM W
8 mm	.130 (3.3)	.124 (3.15)	.130 (3.3)	.126 (3.2)	.138 ± .002 (3.5 ± 0.05)	.055 ± .004 (1.4 ± 0.1)	.157 (4)	.008 ± .004 (0.2 ± 0.1)	.315 ± .012 (8 ± 0.3)

Note: UNLESS OTHERWISE SPECIFIED

1. CUMULATIVE PITCH TOLERANCE FOR FEEDING HOLES AND CAVITIES (CHIP POCKETS) NOT TO EXCEED .008 IN / 0.2mm OVER 10 PITCH SPAN.
2. THRU HOLE INSIDE CAVITY IS CENTERED WITHIN CAVITY.

3. SMALLEST ALLOWABLE TAPE BENDING RADIUS: 1.181 IN/ 30mm.
4. DIMENSIONS WITH Δ ARE CRITICAL. DIMENSIONS TO BE ABSOLUTELY INSPECTED.

Reel Dimensions

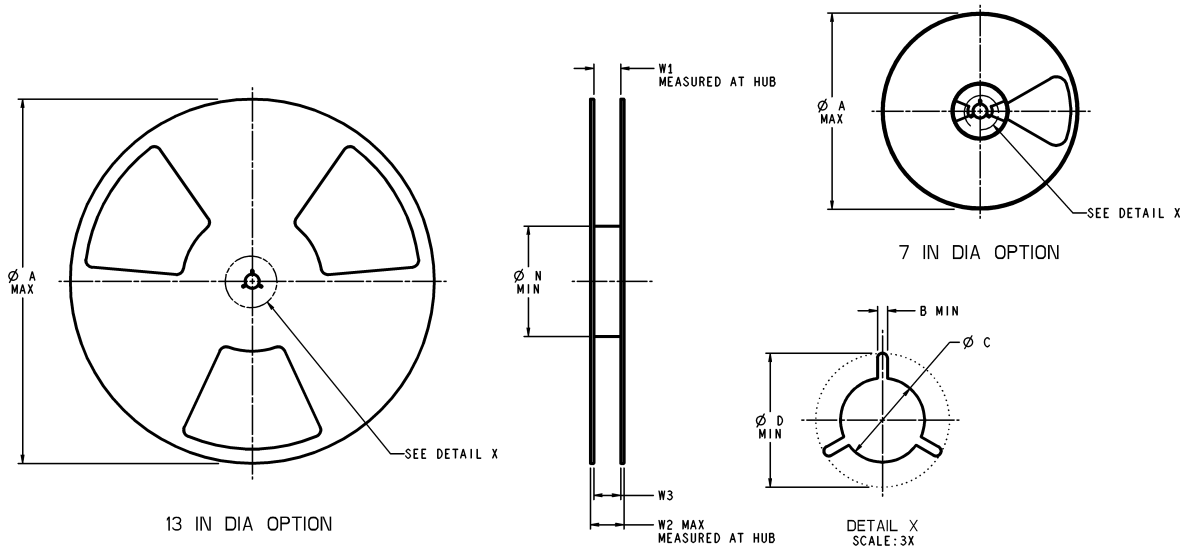

39-1922 (Rev H)

10132554

TAPE SIZE	DIM A	DIM B	DIM C	DIM D	DIM N	DIM W1	DIM W2	DIM W3 (LSL-USL)
8 mm	7.00 (177.8)	.059 (1.5)	.512 + .020/-0.008 (13 +0.5/-0.2)	.795 (20.2)	2.165 (55)	.331 + .059/-0.000 (8.4 + 1.5/0)	.567 (14.4)	.311 - .429 (7.9 - 10.9)

Note: UNLESS OTHERWISE SPECIFIED

1. MATERIAL:

- POLYSTYRENE/PVC (WITH ANTISTATIC COATING).
- OR POLYSTYRENE/PVC, ANTISTATIC
- OR POLYSTYRENE/PVC, CONDUCTIVE.

2. CONTROLLING DIMENSION IS MILLIMETER, DIMENSIONS IN INCHES ROUNDED.

3. SURFACE RESISTIVITY: 10^{10} OHM/SQ MAXIMUM.

4. ALL OUTPUT REELS SHALL BE UNIFORM IN SHADE.

5. PACKING OF REELS IN CONTAINERS MUST ENSURE NO DAMAGE TO THE REEL.

6. SURFACE FINISH OF THE FLANGES SHALL BE SMOOTH, MATTE FINISH PREFERRED.

7. ALL EDGES, ESPECIALLY THE TAPE ENTRY EDGES, MUST BE FREE OF BURRS.

8. THE REEL SHOULD NOT WARP IN THE STORAGE TEMPERATURE OF 67°C MAXIMUM.

9. GLASS TRANSITION TEMPERATURE (T_g) OF THE PLASTIC REEL SHALL BE LOWER THAN -20°C.

10. ALL GATING FROM THE MOLD MUST BE PROPERLY REMOVED.

11. NO FLASHES ARE TO BE PRESENT ALONG THE PARTING LINES.

12. ALLOWABLE RADIUS FOR CORNERS AND EDGES IS .012 INCHES/0.3 MILLIMETERS MINIMUM.

13. SINK MARKS THAT WILL CAUSE A CHANGE TO THE SPECIFIED DIMENSIONS OR SHAPE OF THE REELS ARE NOT ALLOWED.

14. MOLDED REELS SHALL BE FREE OF COSMETIC DEFECTS SUCH AS VOIDS. FLASHING, EXCESSIVE FLOW MARKS, ETC.

15. THERE MUST BE NO MISMATCH BETWEEN MATING PARTS.

16. MOLDED REELS SHALL BE ANTISTATIC COATED OR BLENDED.

17. THE SOT23-5L AND SOT23-6L PACKAGE USE THE 7-INCH REEL.

Physical Dimensions inches (millimeters)

unless otherwise noted

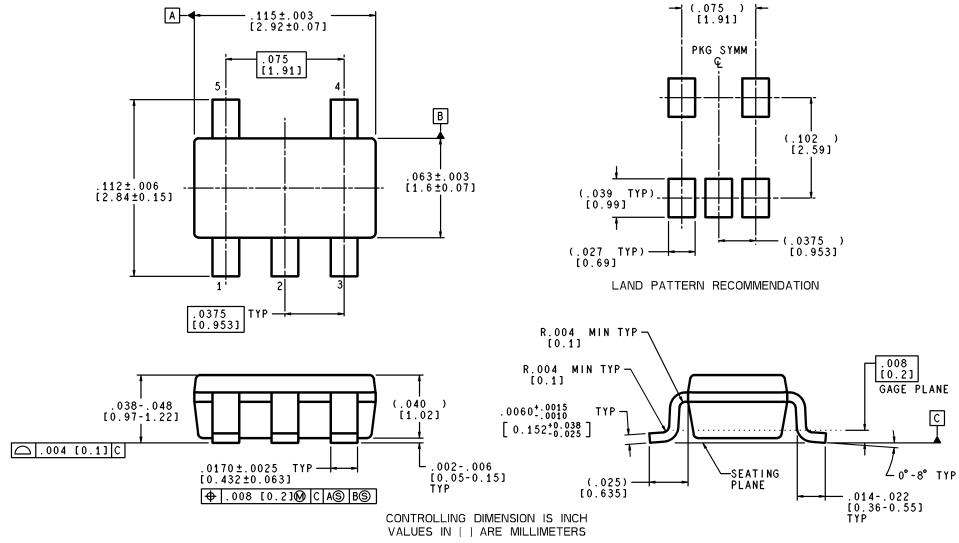

MF05A (Rev A)

SOT23-5 NS Package Number MF05A

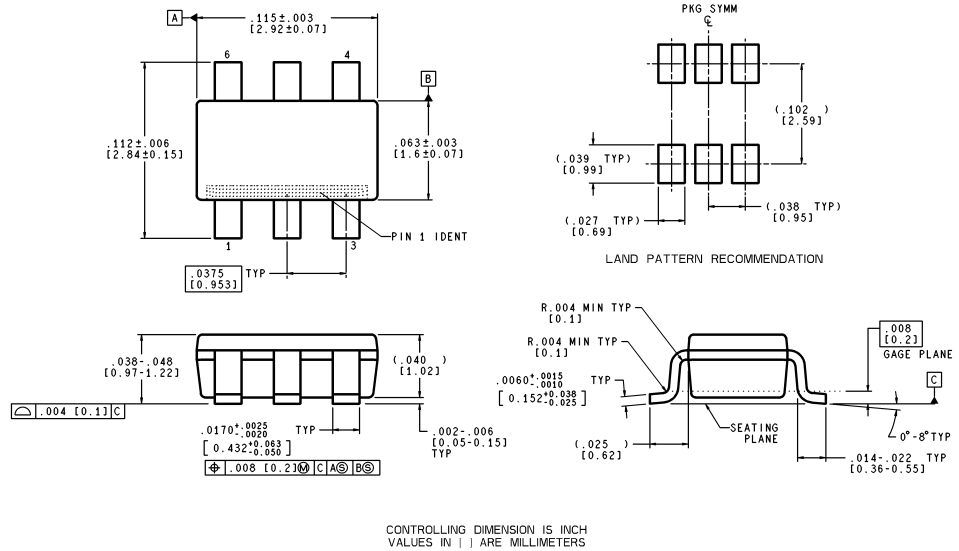

MF06A (Rev A)

SOT23-6 NS Package Number MF06A

Notes

LIFE SUPPORT POLICY

NATIONAL'S PRODUCTS ARE NOT AUTHORIZED FOR USE AS CRITICAL COMPONENTS IN LIFE SUPPORT DEVICES OR SYSTEMS WITHOUT THE EXPRESS WRITTEN APPROVAL OF THE PRESIDENT AND GENERAL COUNSEL OF NATIONAL SEMICONDUCTOR CORPORATION. As used herein:

1. Life support devices or systems are devices or systems which, (a) are intended for surgical implant into the body, or (b) support or sustain life, and whose failure to perform when properly used in accordance with instructions for use provided in the labeling, can be reasonably expected to result in a significant injury to the user.
2. A critical component is any component of a life support device or system whose failure to perform can be reasonably expected to cause the failure of the life support device or system, or to affect its safety or effectiveness.



National Semiconductor
Americas Customer
Support Center
Email: new.feedback@nsc.com
Tel: 1-800-272-9959

www.national.com

National Semiconductor
Europe Customer Support Center
Fax: +49 (0) 180-530 85 86
Email: europe.support@nsc.com
Deutsch Tel: +49 (0) 69 9508 6208
English Tel: +44 (0) 870 24 0 2171
Français Tel: +33 (0) 1 41 91 8790

National Semiconductor
Asia Pacific Customer
Support Center
Fax: 65-6250 4466
Email: ap.support@nsc.com
Tel: 65-6254 4466

National Semiconductor
Japan Customer Support Center
Fax: 81-3-5639-7507
Email: nsj.crc@jksmp.nsc.com
Tel: 81-3-5639-7560