



Integrated
Circuit
Systems, Inc.

PRELIMINARY

ICS840001-32 FEMTOCLOCKS™ CRYSTAL-TO- LVCMOS/LVTTL FREQUENCY SYNTHESIZER

GENERAL DESCRIPTION

The ICS840001-32 is a two output LVCMOS/LVTTL Synthesizer and is a member of the HiPerClocks™ family of high performance devices from ICS. The device uses a 40MHz crystal to provide a 40MHz reference clock output and to synthesize a 100MHz or 106.25MHz output. The ICS840001-32 has excellent <1ps phase jitter performance over the 637kHz – 5MHz integration range. The ICS840001-32 is packaged in a 3mm x 3mm 16-pin VFQFN, making it ideal for use on space constrained boards.

FEATURES

- One LVCMOS/LVTTL output, 15Ω typical output impedance and one reference clock output
- 40MHz, 10pF parallel resonant crystal
- Output frequencies: 100MHz or 106.25MHz
- RMS phase jitter @ 106.25MHz, using a 40MHz crystal (637kHz - 5MHz): 0.78ps (typical)
- 3.3V operating supply
- 0°C to 70°C ambient operating temperature
- Available in both standard and lead-free RoHS-compliant packages

FUNCTION TABLE

Inputs		Outputs	
Crystal Frequency (MHz)	SEL Input	Q Output Frequency (MHz)	REF_OUT Frequency (MHz)
40	0	100	40
40	1	106.25	40

BLOCK DIAGRAM

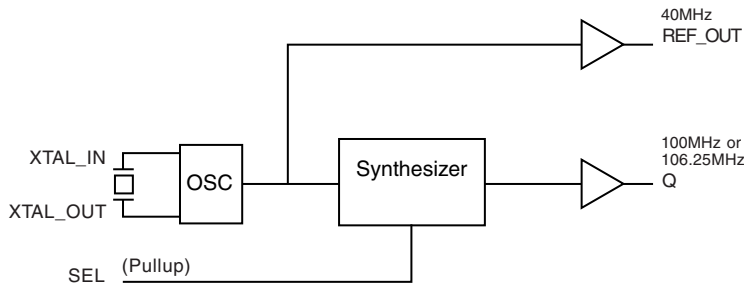

PIN ASSIGNMENT

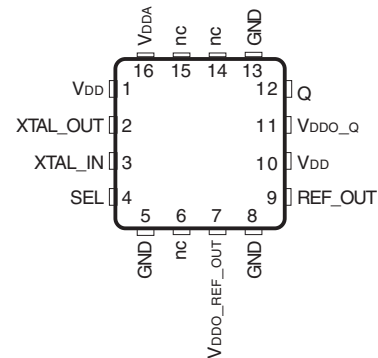

ICS840001-32

16-Lead VFQFN

3mm x 3mm x 0.95 package body

K Package

Top View

The Preliminary Information presented herein represents a product in prototyping or pre-production. The noted characteristics are based on initial product characterization. Integrated Circuit Systems, Incorporated (ICS) reserves the right to change any circuitry or specifications without notice.



TABLE 1. PIN DESCRIPTIONS

Number	Name	Type		Description
1, 10	V _{DD}	Power		Core supply pin.
2, 3	XTAL_OUT, XTAL_IN	Input		Crystal oscillator interface. XTAL_IN is the input. XTAL_OUT is the output.
4	SEL	Input	Pullup	Select input. LVCMOS/LVTTL interface levels.
5, 8, 13	GND	Power		Power supply ground.
6, 14, 15	nc	Unused		No connect.
7	V _{DDO_REF_OUT}	Power		Output supply pin for REF_OUT output
9	REF_OUT	Output		Single-ended three-state reference clock output. LVCMOS/LVTTL interface levels. 15Ω typical output impedance.
11	V _{DDO_Q}	Power		Output supply pin for Q output.
12	Q	Output		Single-ended clock output. LVCMOS/LVTTL interface levels. 15Ω typical output impedance.
16	V _{DDA}	Power		Analog supply pin.

NOTE: *Pullup* refers to internal input resistors. See Table 2, Pin Characteristics, for typical values.

TABLE 2. PIN CHARACTERISTICS

Symbol	Parameter	Test Conditions	Minimum	Typical	Maximum	Units
C _{IN}	Input Capacitance			4		pF
C _{PD}	Power Dissipation Capacitance	V _{DD} , V _{DDA} , V _{DDO_REF_OUT} , V _{DDO_Q} = 3.465V		8		pF
R _{PULLUP}	Input Pullup Resistor			51		kΩ
R _{OUT}	Output Impedance			15		Ω



ABSOLUTE MAXIMUM RATINGS

Supply Voltage, V_{DD}	4.6V
Inputs, V_i	-0.5V to $V_{DD} + 0.5V$
Outputs, V_o	-0.5V to $V_{DDO} + 0.5V$
Package Thermal Impedance, θ_{JA}	51.5°C/W (0 lfpm)
Storage Temperature, T_{STG}	-65°C to 150°C

NOTE: Stresses beyond those listed under Absolute Maximum Ratings may cause permanent damage to the device. These ratings are stress specifications only. Functional operation of product at these conditions or any conditions beyond those listed in the *DC Characteristics* or *AC Characteristics* is not implied. Exposure to absolute maximum rating conditions for extended periods may affect product reliability.

TABLE 3A. POWER SUPPLY DC CHARACTERISTICS, $V_{DD} = V_{DDA} = V_{DDO_REF_OUT} = V_{DDO_Q} = 3.3V \pm 5\%$, $T_A = 0^\circ C$ TO $70^\circ C$

Symbol	Parameter	Test Conditions	Minimum	Typical	Maximum	Units
V_{DD}	Core Supply Voltage		3.135	3.3	3.465	V
V_{DDA}	Analog Supply Voltage		3.135	3.3	3.465	V
V_{DDO}	Output Supply Voltage		3.135	3.3	3.465	V
I_{DD}	Power Supply Current			70		mA
I_{DDA}	Analog Supply Current			25		mA
I_{DDO}	Output Supply Current			12		mA

TABLE 3B. LVCMOS/LVTTL DC CHARACTERISTICS, $V_{DD} = V_{DDA} = V_{DDO_REF_OUT} = V_{DDO_Q} = 3.3V \pm 5\%$, $T_A = 0^\circ C$ TO $70^\circ C$

Symbol	Parameter	Test Conditions	Minimum	Typical	Maximum	Units
V_{IH}	Input High Voltage		2		$V_{DD} + 0.3$	V
V_{IL}	Input Low Voltage		-0.3		0.8	V
I_{IH}	Input High Current	$V_{DD} = V_{IN} = 3.465V$			5	μA
I_{IL}	Input Low Current	$V_{DD} = 3.465V, V_{IN} = 0V$	-150			μA
V_{OH}	Output High Voltage; NOTE 1		2.6			V
V_{OL}	Output Low Voltage; NOTE 1				0.5	V

NOTE 1: Outputs terminated with 50 Ω to $V_{DDO_X}/2$ See Parameter Measurement Information Section, "3.3V Output Load Test Circuit".

TABLE 4. CRYSTAL CHARACTERISTICS

Parameter	Test Conditions	Minimum	Typical	Maximum	Units
Mode of Oscillation		Fundamental			
Frequency			40		MHz
Equivalent Series Resistance (ESR)				50	Ω
Shunt Capacitance				7	pF
Drive Level			10	100	μW



Integrated
Circuit
Systems, Inc.

PRELIMINARY

ICS840001-32
FEMTOCLOCKS™ CRYSTAL-TO-
LVCMOS/LVTTL FREQUENCY SYNTHESIZER

TABLE 5. AC CHARACTERISTICS, $V_{DD} = V_{DDA} = V_{DDO_REF_OUT} = V_{DDO_Q} = 3.3V \pm 5\%$, $T_A = 0^\circ C$ TO $70^\circ C$

Symbol	Parameter	Test Conditions	Minimum	Typical	Maximum	Units
f_{OUT}	Output Frequency	REF_OUT	$f_SEL = 0$		100	MHz
		Q	$f_SEL = 1$		106.25	MHz
$f_{jit}(\emptyset)$	RMS Phase Jitter (Random)		100MHz, Integration Range: 637kHz to 5MHz		0.83	ps
			106.25MHz, Integration Range: 637kHz to 5MHz		0.78	ps
t_R / t_F	Output Rise/Fall Time		20% to 80%		900	ps
odc	Output Duty Cycle				50	%

All parameters are characterized @ 100MHz and 106.25MHz.



Integrated
Circuit
Systems, Inc.

PRELIMINARY

ICS840001-32
FEMTOCLOCKS™ CRYSTAL-TO-
LVCMOS/LVTTL FREQUENCY SYNTHESIZER

TYPICAL PHASE NOISE AT 106.25MHz

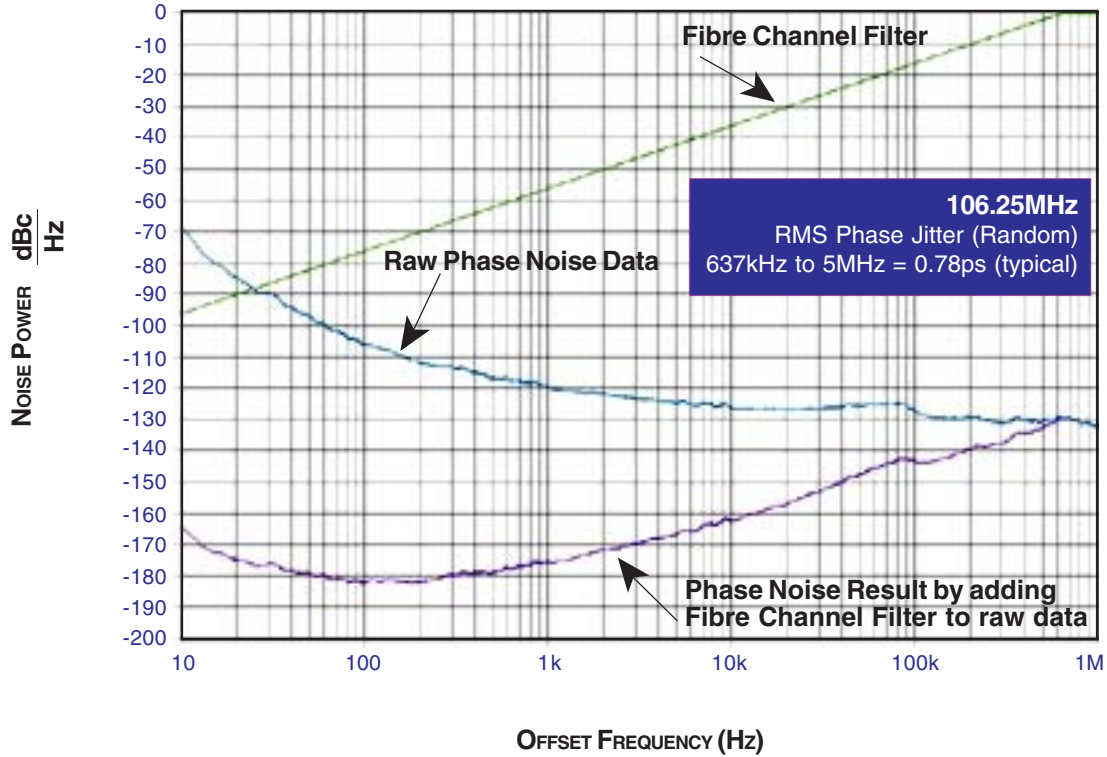



PARAMETER MEASUREMENT INFORMATION

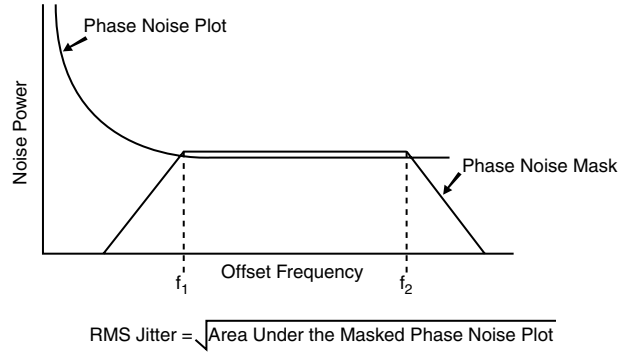
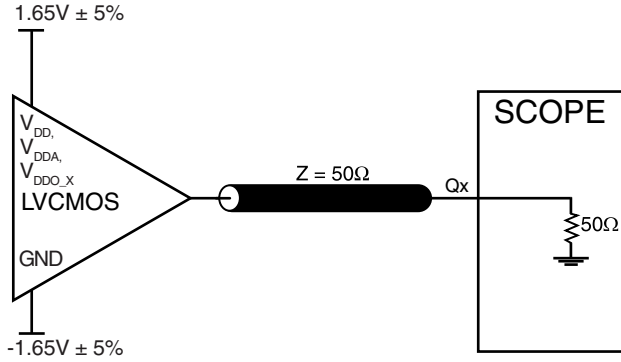

3.3V OUTPUT LOAD AC TEST CIRCUIT

RMS PHASE JITTER

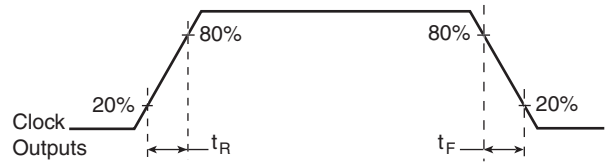
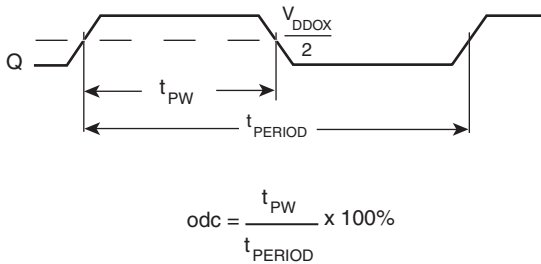

OUTPUT DUTY CYCLE/PULSE WIDTH/PERIOD

OUTPUT RISE/FALL TIME



APPLICATION INFORMATION

POWER SUPPLY FILTERING TECHNIQUES

As in any high speed analog circuitry, the power supply pins are vulnerable to random noise. The ICS840001-32 provides separate power supplies to isolate any high switching noise from the outputs to the internal PLL. V_{DD} , V_{DDA} and V_{DDO_X} should be individually connected to the power supply plane through vias, and bypass capacitors should be used for each pin. To achieve optimum jitter performance, power supply isolation is required. *Figure 1* illustrates how a 10Ω resistor along with a $10\mu\text{F}$ and a $.01\mu\text{F}$ bypass capacitor should be connected to each V_{DDA} pin. The 10Ω resistor can also be replaced by a ferrite bead.

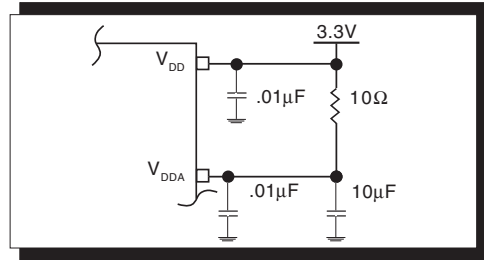

FIGURE 1. POWER SUPPLY FILTERING

CRYSTAL INPUT INTERFACE

The ICS840001-32 has been characterized with 10pF parallel resonant crystals. The capacitor values, $C1$ and $C2$, shown in *Figure 2* below were determined using a 40MHz , 10pF

parallel resonant crystal and were chosen to minimize the ppm error. The optimum $C1$ and $C2$ values can be slightly adjusted for different board layouts.

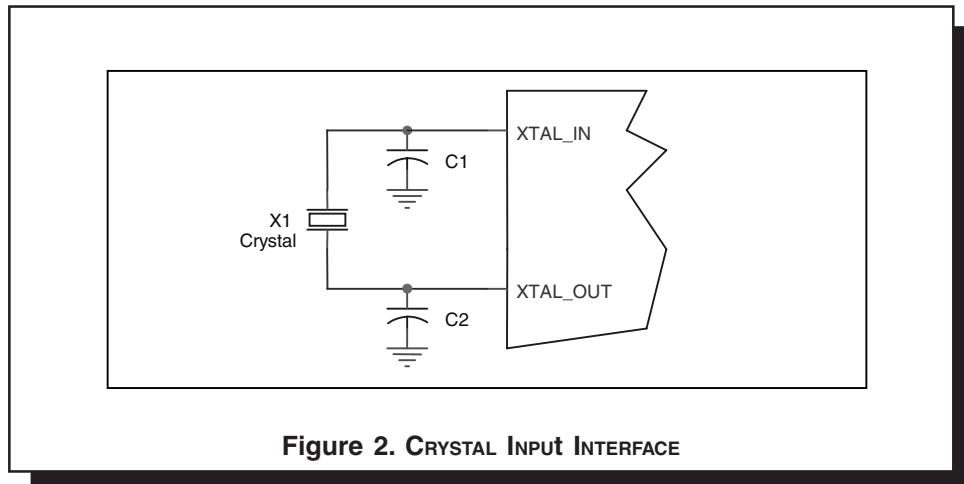

Figure 2. CRYSTAL INPUT INTERFACE



Integrated
Circuit
Systems, Inc.

PRELIMINARY

ICS840001-32
FEMTOCLOCKS™ CRYSTAL-TO-
LVCMOS/LVTTL FREQUENCY SYNTHESIZER

RELIABILITY INFORMATION

TABLE 7. θ_{JA} vs. AIR FLOW TABLE FOR 16 LEAD VFQFN

θ_{JA} vs. 0 Air Flow (Linear Feet per Minute)	
Multi-Layer PCB, JEDEC Standard Test Boards	0 51.5°C/W

TRANSISTOR COUNT

The transistor count for ICS840001-32 is: 2121



PACKAGE OUTLINE - K SUFFIX FOR 16 LEAD VFQFN

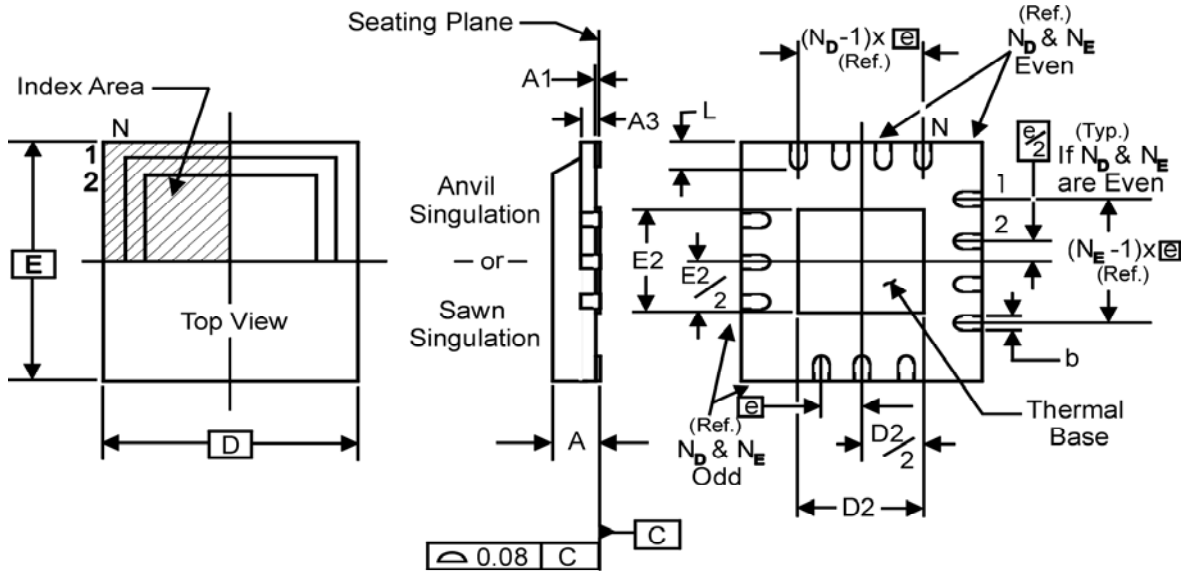

TABLE 8. PACKAGE DIMENSIONS

JEDEC VARIATION ALL DIMENSIONS IN MILLIMETERS		
SYMBOL	MINIMUM	MAXIMUM
N	16	
A	0.80	1.0
A1	0	0.05
A3	0.25 Reference	
b	0.18	0.30
e	0.50 BASIC	
N _D	4	
N _E	4	
D	3.0	
D2	0.25	1.25
E	3.0	
E2	0.25	1.25
L	0.30	0.50

Reference Document: JEDEC Publication 95, MO-220



Integrated
Circuit
Systems, Inc.

PRELIMINARY

ICS840001-32
FEMTOCLOCKS™ CRYSTAL-TO-
LVC MOS/LVTTL FREQUENCY SYNTHESIZER

TABLE 9. ORDERING INFORMATION

Part/Order Number	Marking	Package	Shipping Packaging	Temperature
ICS840001CK-32	1C32	16 Lead VFQFN	tray	0°C to 70°C
ICS840001CK-32T	1C32	16 Lead VFQFN	2500 tape & reel	0°C to 70°C
ICS840001CK-32LF	TBD	16 Lead "Lead-Free" VFQFN	tray	0°C to 70°C
ICS840001CK-32LFT	TBD	16 Lead "Lead-Free" VFQFN	2500 tape & reel	0°C to 70°C

NOTE: Parts that are ordered with an "LF" suffix to the part number are the Pb-Free configuration and are RoHS compliant.

The aforementioned trademarks, HiPerClockS and FemtoClocks are trademarks of Integrated Circuit Systems, Inc. or its subsidiaries in the United States and/or other countries.

While the information presented herein has been checked for both accuracy and reliability, Integrated Circuit Systems, Incorporated (ICS) assumes no responsibility for either its use or for infringement of any patents or other rights of third parties, which would result from its use. No other circuits, patents, or licenses are implied. This product is intended for use in normal commercial applications. Any other applications such as those requiring extended temperature range, high reliability or other extraordinary environmental requirements are not recommended without additional processing by ICS. ICS reserves the right to change any circuitry or specifications without notice. ICS does not authorize or warrant any ICS product for use in life support devices or critical medical instruments.