



TF202THC

N-Channel JFET 20V, 140 to 350 μ A, 1.0mS, VTFP

ON Semiconductor®

<http://onsemi.com>

Features

- Ultrasmall package facilitates miniaturization in end products
- Especially suited for use in electret condenser microphone for audio equipments and telephones
- Excellent voltage characteristics
- Excellent transient characteristics
- Adoption of FBET process
- Halogen free compliance

Specifications

Absolute Maximum Ratings at Ta=25°C

Parameter	Symbol	Conditions	Ratings	Unit
Gate to Drain Voltage	VGDO		-20	V
Gate Current	IG		10	mA
Drain Current	ID		1	mA
Allowable Power Dissipation	PD		100	mW
Junction Temperature	Tj		150	°C
Storage Temperature	Tstg		-55 to +150	°C

Stresses exceeding those listed in the Maximum Ratings table may damage the device. If any of these limits are exceeded, device functionality should not be assumed, damage may occur and reliability may be affected.

Package Dimensions

unit : mm (typ)

7031A-001

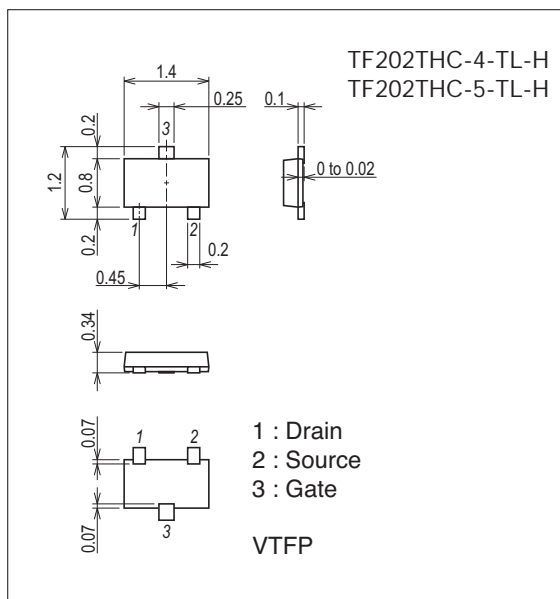

Product & Package Information

- Package : VTFP
- JEITA, JEDEC : SC-106A
- Minimum Packing Quantity : 8,000 pcs./reel

Packing Type: TL

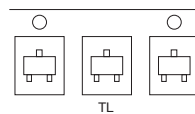

Marking

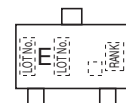

Electrical Connection

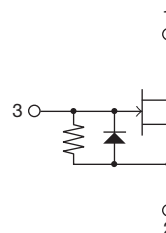

TF202THC

Electrical Characteristics at Ta=25°C

Parameter	Symbol	Conditions	Ratings			Unit
			min	typ	max	
Gate to Drain Breakdown Voltage	V(BR)GDO	I _G =-100μA	-20			V
Cutoff Voltage	V _{GS(off)}	V _{DS} =5V, I _D =1μA	-0.2	-0.6	-1.0	V
Drain Current	I _{DSS}	V _{DS} =5V, V _{GS} =0V	140*		350*	μA
Forward Transfer Admittance	y _{fs}	V _{DS} =5V, V _{GS} =0V, f=1kHz	0.5	1.0		mS
Input Capacitance	C _{iss}	V _{DS} =5V, V _{GS} =0V, f=1MHz		3.5		pF
Reverse Transfer Capacitance	C _{rss}	V _{DS} =5V, V _{GS} =0V, f=1MHz		0.65		pF
[Ta=25°C, V _{CC} =4.5V, R _L =1kΩ, C _{in} =15pF, See specified Test Circuit.]						
Voltage Gain	GV	V _{IN} =10mV, f=1kHz		-3.0		dB
Reduced Voltage Characteristic	ΔGV	V _{IN} =10mV, f=1kHz, V _{CC} =4.5V → 1.5V		-1.2	-3.5	dB
Frequency Characteristic	ΔGvf	f=1kHz to 110Hz			-1.0	dB
Input Impedance	Z _{IN}	f=1kHz	25			MΩ
Output Impedance	Z _O	f=1kHz		1000		Ω
Total Harmonic Distortion	THD	V _{IN} =30mV, f=1kHz		1.2		%
Output Noise Voltage	V _{NO}	V _{IN} =0V, A Curve			-110	dB

Product parametric performance is indicated in the Electrical Characteristics for the listed test conditions, unless otherwise noted. Product performance may not be indicated by the Electrical Characteristics if operated under different conditions.

* : The TF202THC is classified by I_{DSS} as follows : (unit : μA)

Rank	4	5
I _{DSS}	140 to 240	210 to 350

Test Circuit

- Voltage gain
- Frequency Characteristic
- Distortion
- Reduced Voltage Characteristic

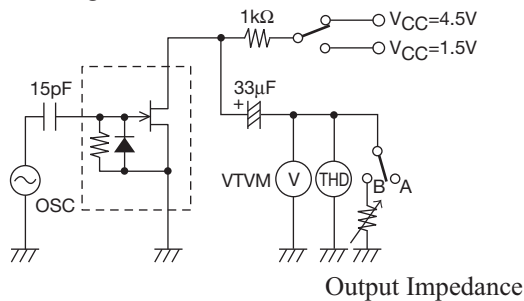

Ordering Information

Device	Package	Shipping	memo
TF202THC-4-TL-H	VTFP	8,000pcs./reel	Pb Free and Halogen Free
TF202THC-5-TL-H	VTFP	8,000pcs./reel	

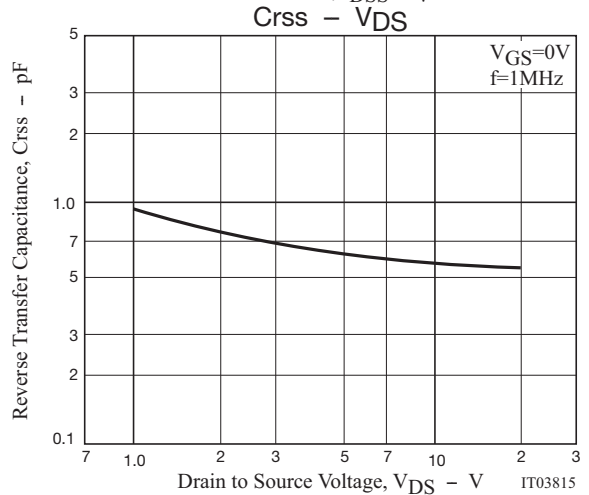
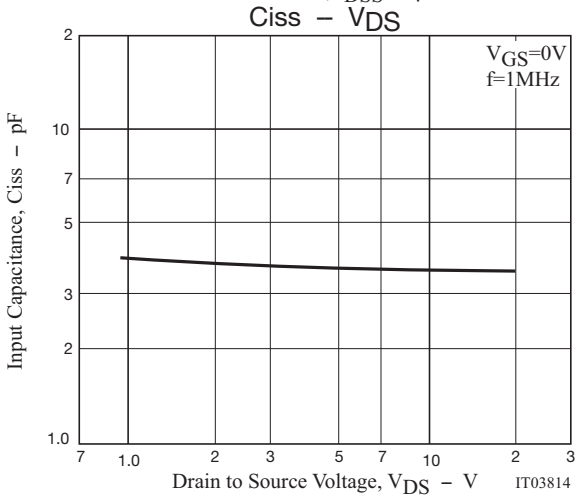
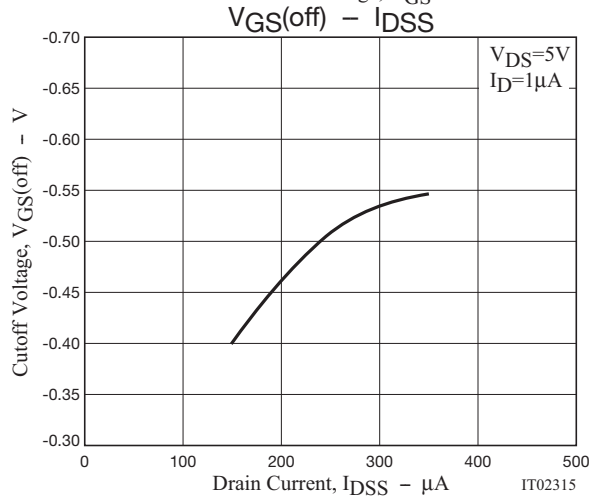
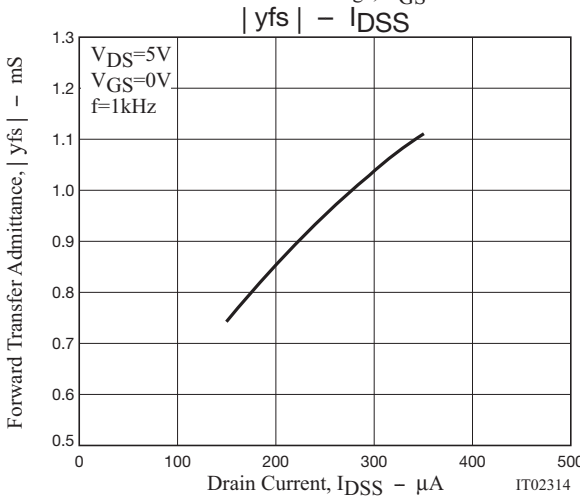
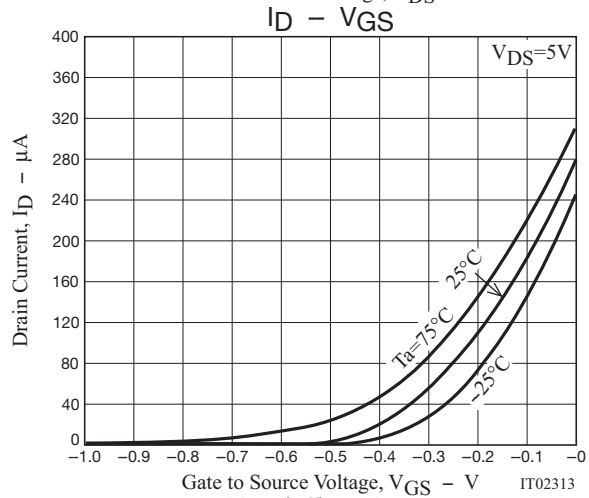
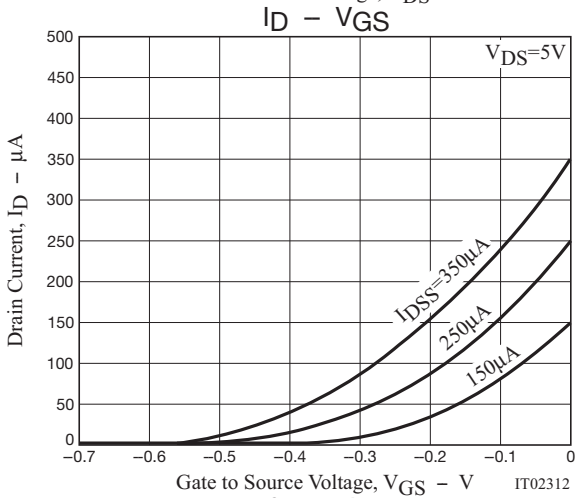
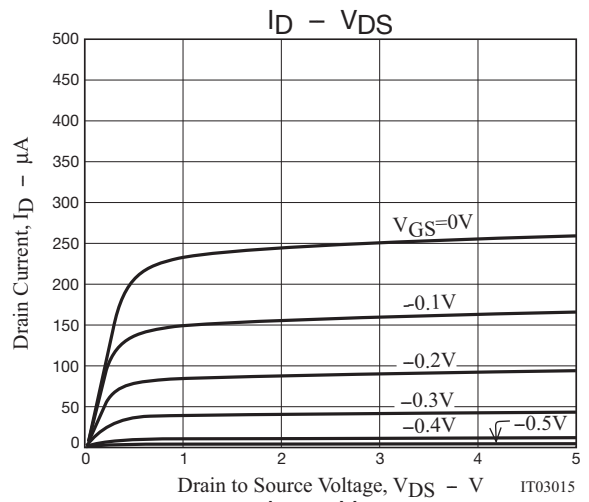
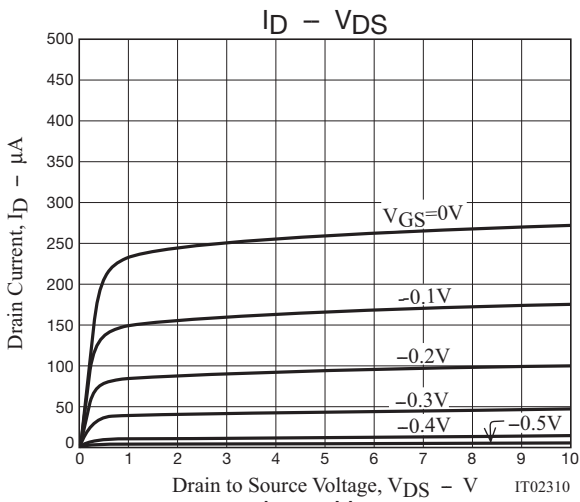

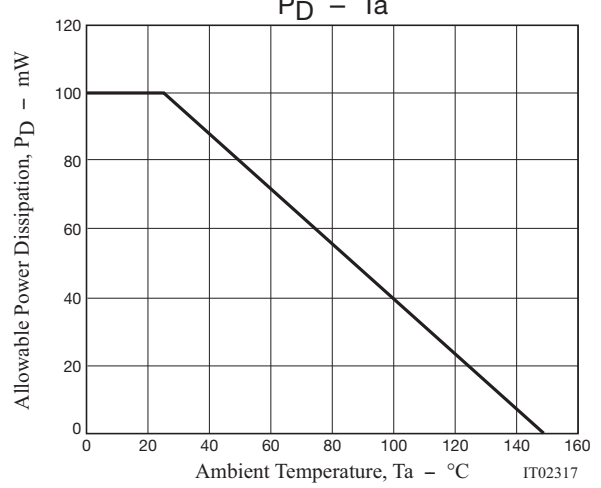
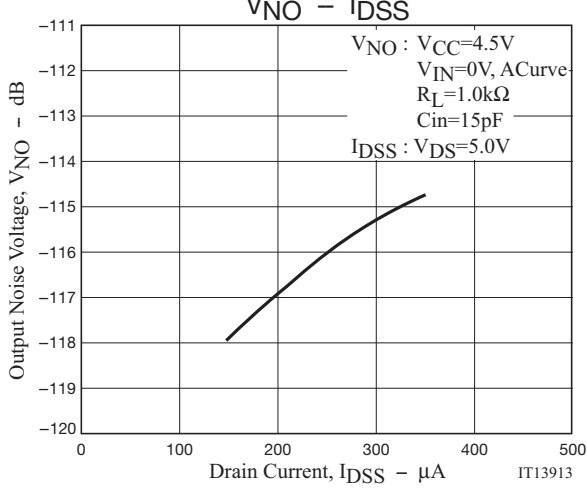
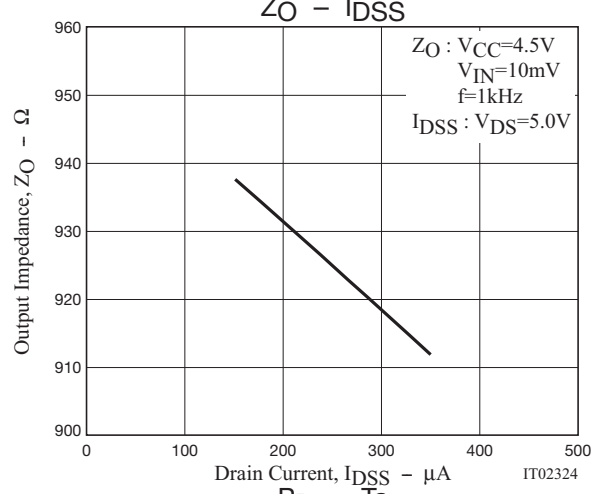
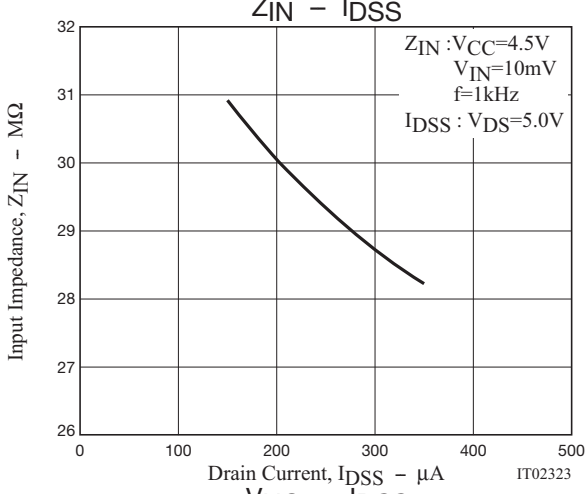
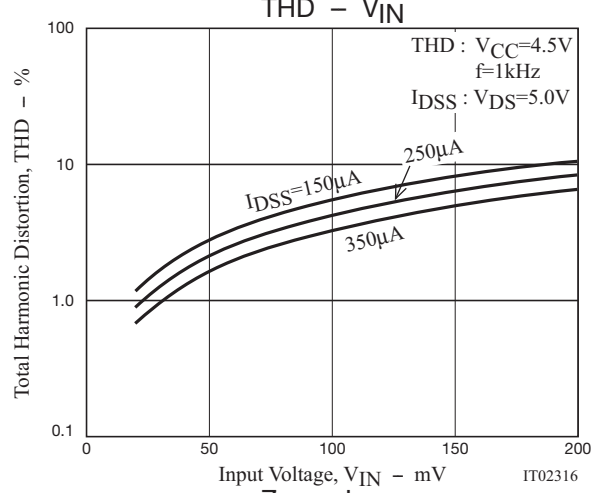
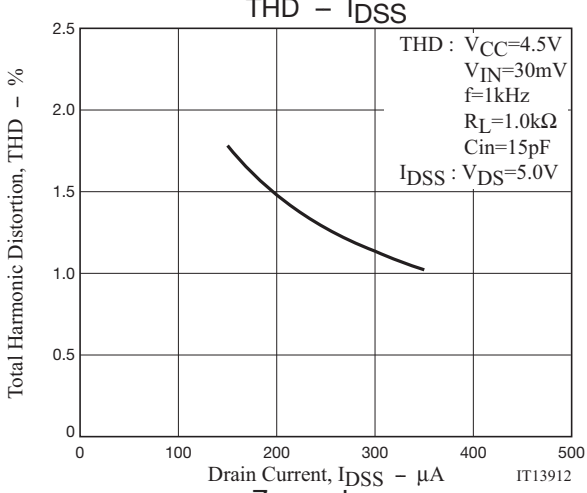
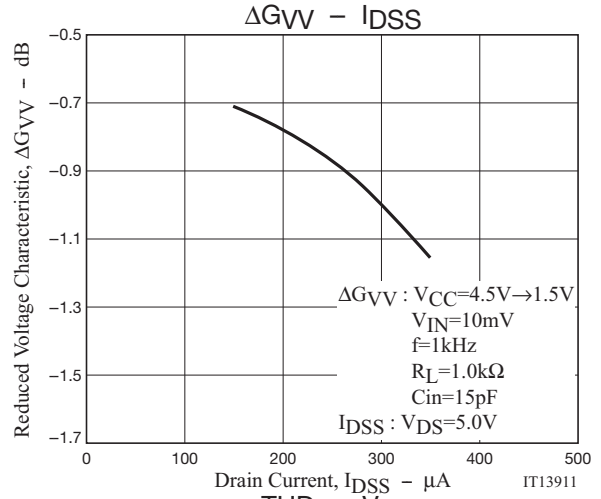
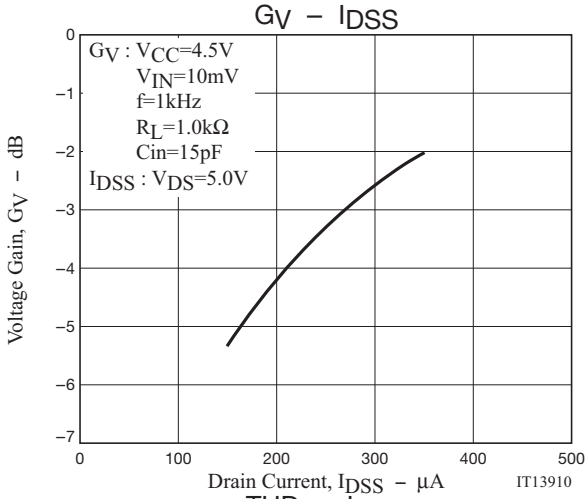

TF202THC

Outline Drawing

TF202THC-4-TL-H, TF202THC-5-TL-H

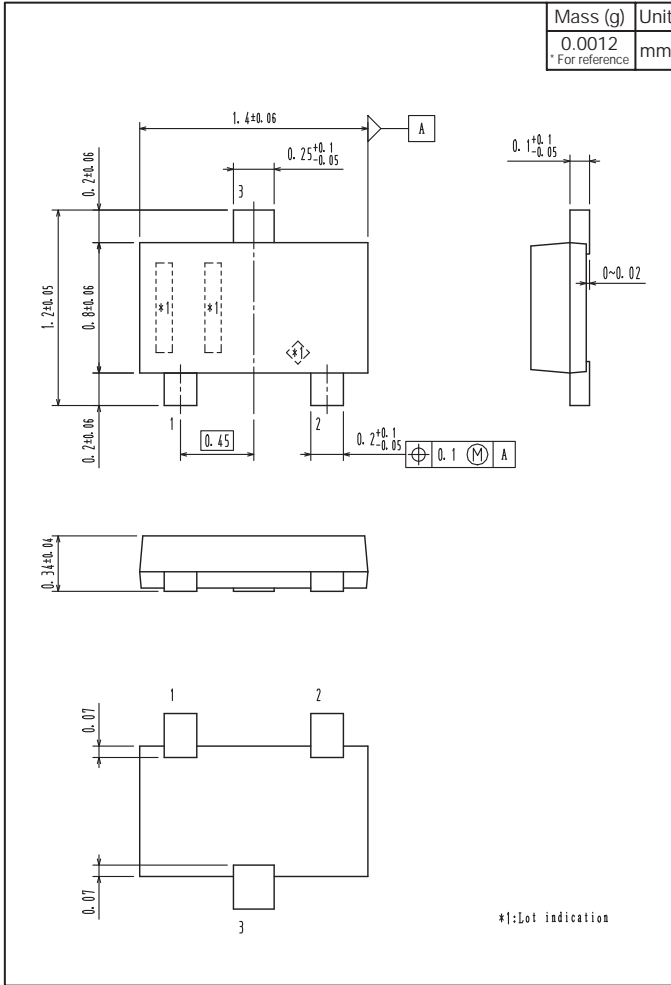

Land Pattern Example

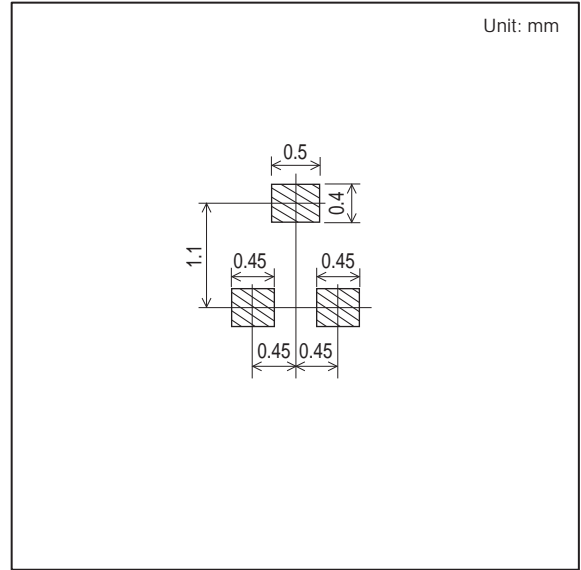

ON Semiconductor and the ON logo are registered trademarks of Semiconductor Components Industries, LLC (SCILLC) or its subsidiaries in the United States and/or other countries. SCILLC owns the rights to a number of patents, trademarks, copyrights, trade secrets, and other intellectual property. A listing of SCILLC's product/patent coverage may be accessed at www.onsemi.com/site/pdf/Patent-Marking.pdf. SCILLC reserves the right to make changes without further notice to any products herein. SCILLC makes no warranty, representation or guarantee regarding the suitability of its products for any particular purpose, nor does SCILLC assume any liability arising out of the application or use of any product or circuit, and specifically disclaims any and all liability, including without limitation special, consequential or incidental damages. "Typical" parameters which may be provided in SCILLC data sheets and/or specifications can and do vary in different applications and actual performance may vary over time. All operating parameters, including "Typicals" must be validated for each customer application by customer's technical experts. SCILLC does not convey any license under its patent rights nor the rights of others. SCILLC products are not designed, intended, or authorized for use as components in systems intended for surgical implant into the body, or other applications intended to support or sustain life, or for any other application in which the failure of the SCILLC product could create a situation where personal injury or death may occur. Should Buyer purchase or use SCILLC products for any such unintended or unauthorized application, Buyer shall indemnify and hold SCILLC and its officers, employees, subsidiaries, affiliates, and distributors harmless against all claims, costs, damages, and expenses, and reasonable attorney fees arising out of, directly or indirectly, any claim of personal injury or death associated with such unintended or unauthorized use, even if such claim alleges that SCILLC was negligent regarding the design or manufacture of the part. SCILLC is an Equal Opportunity/Affirmative Action Employer. This literature is subject to all applicable copyright laws and is not for resale in any manner.