

PVA Pick-to-Light Array

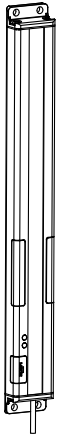

Datasheet

Light Screen for Error-Proofing of Bin-Picking Operations



- Compact package, available in 4 lengths to fit many sizes and configurations of existing parts bins
- Range up to 2 m (6.5 ft)
- Two-component system (asynchronous emitter and receiver) needs no sync wire or controller box.
- Emitters and receivers sold separately or in pairs for easy ordering.
- Two LEDs on each emitter and receiver indicate proper setup and system errors.
- Clearly visible green job indicator lights mounted on either side of emitter and receiver housings; the light can be remotely controlled to initiate user action with a solid ON or blinking condition
- Two frequency settings to prevent crosstalk in close-proximity, multiple-array installations
- Easy DIP-switch selection of light/dark operate, solid/flashing job light, A/B frequency, and gate polarity for activating the job light indicator.
- Choose 2 m (6.5 ft) unterminated cable or 2 m (6.5 ft) cable with 4-pin Euro-style quick-disconnect connector.
- PNP or NPN receiver output, depending on model
- 12 to 30V dc operation
- Minimum resolution 35 mm (1.4 in)
- Wide beam pattern for easy alignment
- Heavy-duty protective brackets available



WARNING: Not To Be Used for Personnel Protection

Never use this device as a sensing device for personnel protection. Doing so could lead to serious injury or death. This device does not include the self-checking redundant circuitry necessary to allow its use in personnel safety applications. A sensor failure or malfunction can cause either an energized or de-energized sensor output condition.

Models



NOTE: Additional models on the next page.



NOTE: Cable diameter is 3.3 mm (0.13 in) on all models.

Model ¹	Description	Array Length / # Beams	Job Light Input ²	Receiver Output
PVA100N6	Emitter/Receiver Pair	100 mm (4 in) Long, 5 Beams	0V dc	NPN (Sinking)
PVA100N6E	Emitter			
PVA100N6R	Receiver			
PVA100P6	Emitter/Receiver Pair		+5 to 30V dc	PNP (Sourcing)
PVA100P6E	Emitter			
PVA100P6R	Receiver			
PVA225N6	Emitter/Receiver Pair	225 mm (9 in) Long, 5 Beams	0V dc	NPN (Sinking)
PVA225N6E	Emitter			
PVA225N6R	Receiver			
PVA225P6	Emitter/Receiver Pair		+5 to 30V dc	PNP (Sourcing)
PVA225P6E	Emitter			
PVA225P6R	Receiver			
PVA300N6	Emitter/Receiver Pair	300 mm (12 in) Long, 13 Beams	0V dc	NPN (Sinking)
PVA300N6E	Emitter			
PVA300N6R	Receiver			

¹ Only cabled models (2 m (6.5 ft) unterminated integral cable) are listed. For 2 m (6.5 ft) pigtail with Euro-style Quick-disconnect fitting, add "Q" to the model number (for example, PVA100N6Q).

² See [Configuration](#) on page 4



Model ¹	Description	Array Length / # Beams	Job Light Input ²	Receiver Output
PVA300P6	Emitter/Receiver Pair		+5 to 30V dc	PNP (Sourcing)
PVA300P6E	Emitter			
PVA300P6R	Receiver			
PVA375N6	Emitter/Receiver Pair	375 mm (15 in) Long, 16 Beams	0V dc	NPN (Sinking)
PVA375N6E	Emitter			
PVA375N6R	Receiver			
PVA375P6	Emitter/Receiver Pair		+5 to 30V dc	PNP (Sourcing)
PVA375P6E	Emitter			
PVA375P6R	Receiver			

Overview

The PVA Series Parts Verification Array is a simple, easy-to-use light screen suited to many part assembly and object detection applications.

The PVA has two components: an emitter and a receiver. The receiver's solid-state output interfaces to a system controller, which is pre-programmed by a supervisor for a specific sequence of tasks. Mounted so that the beams stretch across each bin in an assembler's work station, the PVA then signals the assembler (by means of easy-to-see job lights) which bins contain items to be picked in a given operation and in what order they should be picked.

As the assembler reaches into each bin, the system senses if the correct part has been taken, then signals the next bin in the sequence. The system may be wired to signal an alarm for the assembler and/or a supervisor in the event an incorrect part is selected.

The major benefit of a PVA-driven system is increased efficiency, due to simplified job training, increased quality control (no skipped components), and reduced rework and inspections. The PVA speeds the resumption of work after breaks and other distractions. And it is ideal for multilingual workplaces where communication may be an issue.

Installation

Multiple sensor pairs located farther than the sensor's effective maximum range (approximately 2 m or 6.5 ft) from one another are unlikely to cause crosstalk problems. However, when multiple sensor pairs are mounted in a confined area, take care to avoid crosstalk between them. To avoid crosstalk:

- Alternate the relative position of adjacent emitter/receiver pairs.
- Alternate the Frequency configuration of adjacent pairs.

Mount emitter and receiver pairs parallel, with both cable ends pointing the same direction.

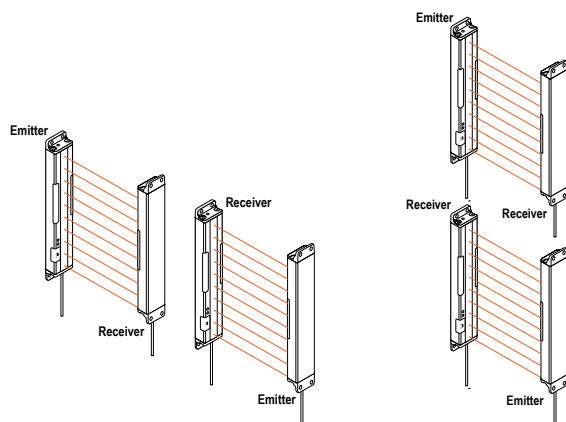

Figure 1. Example—Correct Positions

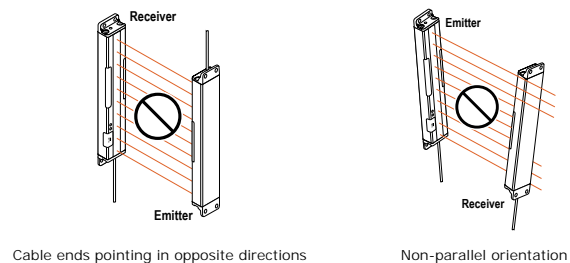

Figure 2. Example—Incorrect Positions

¹ Only cabled models (2 m (6.5 ft) unterminated integral cable) are listed. For 2 m (6.5 ft) pigtail with Euro-style Quick-disconnect fitting, add "Q" to the model number (for example, PVA100N6Q).

² See [Configuration](#) on page 4

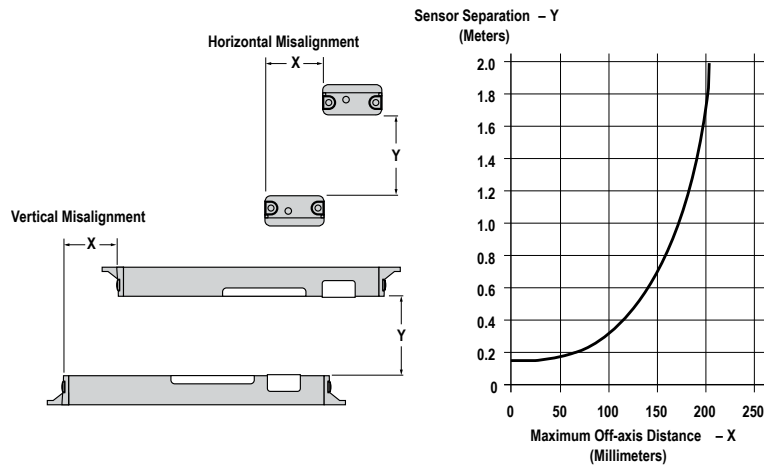

Figure 3. Maximum Off-Axis Misalignment

Mounting

The wide beam pattern of PVA emitters and receivers simplifies their alignment. M4 stainless steel fasteners and two stainless steel brackets are included with each sensor.

Mount each emitter and its corresponding receiver parallel to one another in the same plane, with their cable ends pointing the same direction, and their tops and bottoms aligned.

1. From a common point of reference, make measurements to locate the emitter and receiver in the same plane with their midpoints directly opposite each other.
2. Mount the included brackets to the top and bottom of each sensor, as shown.
3. Mount the emitter and receiver in their brackets, being careful to position the red lenses of the two units directly facing each other. (Remember, the cable ends of both sensors must point in the same direction to ensure proper sensing.)
4. Measure from one or more reference planes (for example, the building or bin floor) to the same point(s) on the emitter and receiver to verify their mechanical alignment. (If the sensors are mounted exactly vertical or horizontal, a carpenter's level may be helpful. A straightedge or a string extended between the sensors may also be helpful.)
5. Also check "by eye" for line-of-sight alignment.
6. Make any necessary final mechanical adjustments, and hand-tighten the bracket hardware.
7. After the electrical hookup is complete, check for beam alignment. If necessary, re-align the emitter and receiver at that time.

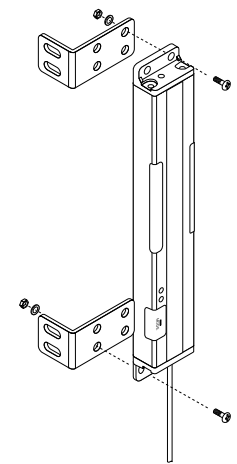
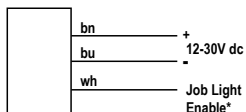

Figure 4. PVA Mounting Hardware

Hookups

All models feature integral 2 m (6.5 ft) long, 3.3 mm (0.13 inch) dia. PVC-jacketed cables. Models whose model numbers end in "Q" are terminated with quick-disconnect (QD) Euro-style 4-pin connectors; other models have unterminated ends.

Emitter with Unterminated Cable



Emitter with 4-Pin Euro QD

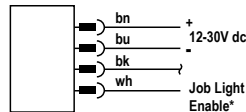

Receiver with NPN (Sinking) Output

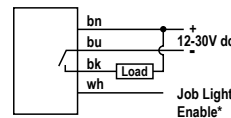

Receiver with PNP (Sourcing) Output

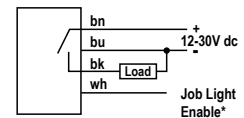

Wiring is functionally identical for cabled and quick-disconnect receiver models.



* See [Configuration](#) on page 4 for job light enable input requirements.



NOTE: Blue wire (dc common) is internally connected to emitter and receiver housings.

Configuration

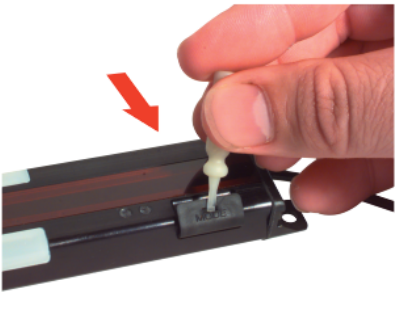
PVA configuration is accomplished using the DIP switches on the emitter and receiver as shown. When setting the DIP switches, use the supplied plastic screwdriver to avoid damaging the switches or causing a short circuit.

Cover Removal	Cover Replacement	
		
<p>Insert a fingernail or small screwdriver into the slot; apply gentle pressure, angling away from the sensor lens. The cover will remain tethered to the sensor housing.</p>	<p>To replace the switch cover, align one edge of the cover with the edge of the sensor housing opening. Then press the front corners into place.</p>	

The switches determine four status operating modes:

- A/B frequency (to avoid crosstalk from multiple pairs of sensors)
- Light/dark operate
- Solid/flashing job light (depending on assembler and/or supervisor preference)
- Gate polarity

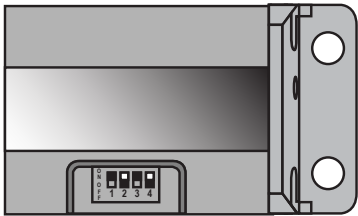
PVA Configuration DIP Switch Settings			
*default settings	Switch	Emitter	Receiver
 <p>ON Example Shown: ↑ Switch #1 OFF Switch #2 ON ↓ Switch #3 OFF Switch #4 ON OFF</p> <p><i>Figure 5. Configuration DIP switch setting positions</i></p>	1 ³	*ON = Frequency A OFF = Frequency B	*ON = Frequency A OFF = Frequency B
	2	No function	ON = Light operate *OFF = Dark operate
	3	*ON = Job light steady OFF = Job light flashes	*ON = Job light steady OFF = Job light flashes
	4	Job light control input: connect the white wire of the emitter and receiver as follows: Models PVA...P6 ON = Job light ON for +5 to 30V dc (27K input impedance) *OFF = Job light ON for 0 to 2V dc/open circuit Models PVA...N6 ON = Job light ON for +5 to 30V dc/open circuit *OFF = Job light ON for 0 to 2V dc (10K input impedance)	

³ Both emitter and receiver must be set to the same frequency in order to operate.

Status Indicators/Troubleshooting

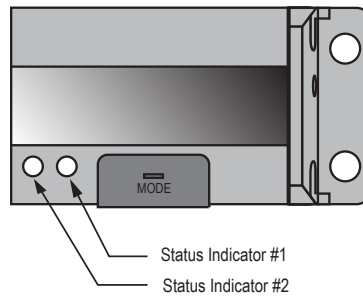

Figure 6. Status indicators

Emitter Indicator	Condition	Description
#1	OFF	Frequency A selected (Emitter/Receiver Switch #1 both ON)
	Steady Red	Frequency B selected (Emitter/Receiver Switch #1 both OFF)
#2	Steady Green	Power is ON and system is OK
	OFF	Power is OFF
	Flashing Green 2x/sec	Emitter Failure (remove and reapply power)

Receiver Indicator	Condition	Description
#1	Steady Yellow	Output is active (change Switch #2 to Light Operate to turn the yellow indicator ON when the system is clear)
	OFF	Output is inactive (change Switch #2 to Dark Operate to turn the yellow indicator ON when the system is blocked)
#2	Steady Green	Power is ON and system is OK
	OFF	Power is OFF
	Flashing Green 1x/sec	Receiver Failure (remove and reapply power)

Specifications

Supply Voltage and Current

12 to 30V dc (10% max. ripple) at less than 62 mA for the emitter and 50 mA for the receiver (exclusive of load)

Supply Protection Circuitry

Protected against reverse polarity

Sensing Range

2 m (6.5 ft) with 2x excess gain remaining

Sensing Height

100 mm (3.9 in), 225 mm (8.9 in), 300 mm (11.8 in), or 375 mm (14.8 in), depending on emitter and receiver models

Beam Spacing

25.0 mm (0.98 in)

Sensing Resolution

35 mm (1.4 in) minimum diameter

Output Configuration

Receivers have one solid-state dc output, programmable for light or dark operate:
 Models PVA...N6R have current sinking (NPN) open-collector transistor
 Models PVA...P6R have current sourcing (PNP) open-collector transistor

Output Rating

150 mA maximum
 OFF-state leakage current: less than 2 microamps
 ON-state saturation voltage: less than 1V dc at 10 mA and less than 1.5V dc at 100 mA

Output Protection

Protected against false pulse on power-up and continuous overload or short circuit of output

Status Indicators

Emitter: Green—power ON/OFF; Red—frequency selected
 Receiver: Green—power ON/OFF; Yellow—output state
 Emitter and Receiver: Two highly visible job lights turn ON and OFF in response to an external signal to the white wire. Job lights may be configured for steady or flashing green.

Construction

Black painted aluminum housing; acrylic lenses; PBT end caps; thermoplastic elastomer programming switch cover; stainless steel mounting brackets and hardware

Connections

Emitter: 3-conductor PVC-jacketed 2 m (6.5 ft) cable which is either unterminated or terminated with a 4-pin Euro-style quick-disconnect connector, depending on model. Cable diameter is 3.3 mm (0.13 in).
 Receiver: 4-conductor PVC-jacketed 2 m (6.5 ft) cable which is either unterminated or terminated with a 4-pin Euro-style quick-disconnect connector, depending on model. Cable diameter is 3.3 mm (0.13 in).

Environmental Rating

NEMA 2: IEC IP62

Operating Temperature

0 °C to +50 °C (+32 °F to +122 °F)

Maximum Off-axis Misalignment

See Figure 3 on page 3

Certifications



Output Response Time

Sensor Size	Standard	With Crosstalk from Adjacent Units
100 mm	20 ms	30 ms
225 mm	40 ms	60 ms
300 mm	52 ms	78 ms
375 mm	64 ms	96 ms

Required Overcurrent Protection



WARNING: Electrical connections must be made by qualified personnel in accordance with local and national electrical codes and regulations.

Overcurrent protection is required to be provided by end product application per the supplied table.

Overcurrent protection may be provided with external fusing or via Current Limiting, Class 2 Power Supply.

Supply wiring leads < 24 AWG shall not be spliced.

For additional product support, go to <http://www.bannerengineering.com>.

Supply Wiring (AWG)	Required Overcurrent Protection (Amps)
20	5.0
22	3.0
24	2.0
26	1.0
28	0.8
30	0.5

Dimensions

Emitter and Receiver

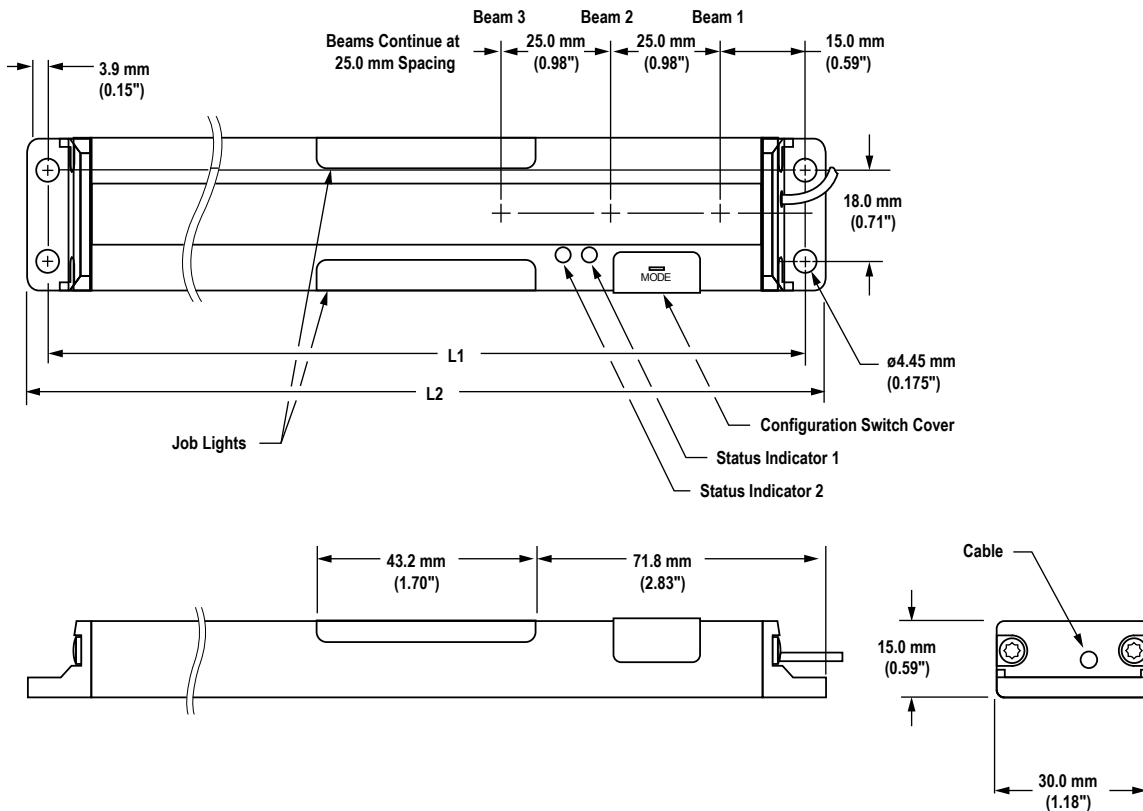

Model	Number of Beams	L ₁	L ₂
PVA100..	5	130.0 mm (5.12 in)	137.8 mm (5.43 in)
PVA225..	10	258.5 mm (10.18 in)	266.4 mm (10.49 in)
PVA300..	13	333.5 mm (13.13 in)	341.4 mm (13.44 in)
PVA375..	16	408.5 mm (16.09 in)	416.6 mm (16.40 in)

SMBPVA1 Standard Bracket (2 Included with PVA)

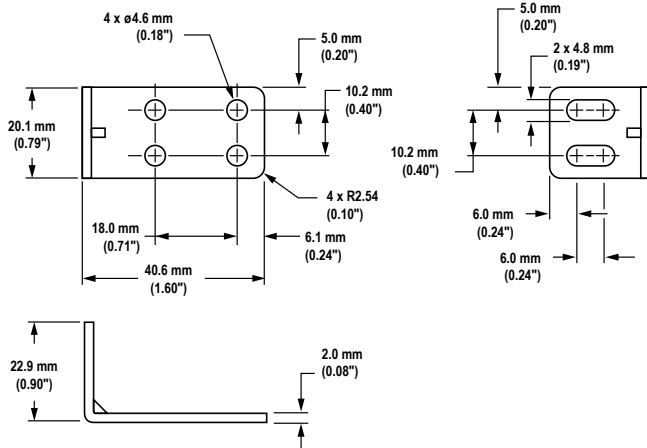

Hardware Included with Each Sensor (kit part number 50532)

Qty	Description
4	Stainless steel Phillips panhead machine screws (M4 x 0.7 x 12)
2	Stainless steel Phillips panhead machine screws (M4 x 0.7 x 6)
2	Stainless steel Phillips panhead machine screws (M4 x 0.7 x 18)
4	Stainless steel hex nuts (M4 x 0.7)
4	Stainless steel lock washers (M4 x 0.7)
1	Plastic screwdriver (3.6 cm/1.4 in long)

Accessories

Cordsets

4-Pin Threaded M12/Euro-Style Cordsets				
Model	Length	Style	Dimensions	Pinout (Female)
MQDC-406	1.83 m (6 ft)	Straight		
MQDC-415	4.57 m (15 ft)			
MQDC-430	9.14 m (30 ft)			
MQDC-450	15.2 m (50 ft)			

Pinout Legend:
 1 = Brown
 2 = White
 3 = Blue
 4 = Black

Brackets



NOTE: Standard SMBPVA1 mounting brackets are included with each PVA System. The following brackets are in addition to the standard brackets.

SMBPVA2

- Set of 4 molded brackets
- Snaps onto standard 28 mm (1.1 in) diameter pipe
- 2 required per sensor



SMBPVA..., SMBPVA..A, SMBPVA..AB

- Protects sensor from impact
- Provides DIP-switch and/or indicator light exposure (depending on model)
- Heavy-duty cold-rolled steel-zinc finish

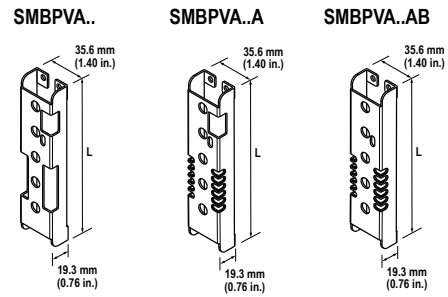

Models	DIP Switch Access	Light Protected	Length (L)	Used With
SMBPVA5	Yes	No	139.7 mm	PVA100
SMBPVA5A	Yes	Yes		
SMBPVA5AB	No	Yes		
SMBPVA10	Yes	No	268.2 mm	PVA225
SMBPVA10A	Yes	Yes		
SMBPVA10AB	No	Yes		
SMBPVA13	Yes	No	343.3 mm	PVA300
SMBPVA13A	Yes	Yes		
SMBPVA13AB	No	Yes		
SMBPVA16	Yes	No	418.2 mm	PVA375
SMBPVA16A	Yes	Yes		
SMBPVA16AB	No	Yes		

Banner Engineering Corp. Limited Warranty

Banner Engineering Corp. warrants its products to be free from defects in material and workmanship for one year following the date of shipment. Banner Engineering Corp. will repair or replace, free of charge, any product of its manufacture which, at the time it is returned to the factory, is found to have been defective during the warranty period. This warranty does not cover damage or liability for misuse, abuse, or the improper application or installation of the Banner product.

THIS LIMITED WARRANTY IS EXCLUSIVE AND IN LIEU OF ALL OTHER WARRANTIES WHETHER EXPRESS OR IMPLIED (INCLUDING, WITHOUT LIMITATION, ANY WARRANTY OF MERCHANTABILITY OR FITNESS FOR A PARTICULAR PURPOSE), AND WHETHER ARISING UNDER COURSE OF PERFORMANCE, COURSE OF DEALING OR TRADE USAGE.

This Warranty is exclusive and limited to repair or, at the discretion of Banner Engineering Corp., replacement. IN NO EVENT SHALL BANNER ENGINEERING CORP. BE LIABLE TO BUYER OR ANY OTHER PERSON OR ENTITY FOR ANY EXTRA COSTS, EXPENSES, LOSSES, LOSS OF PROFITS, OR ANY INCIDENTAL, CONSEQUENTIAL OR SPECIAL DAMAGES RESULTING FROM ANY PRODUCT DEFECT OR FROM THE USE OR INABILITY TO USE THE PRODUCT, WHETHER ARISING IN CONTRACT OR WARRANTY, STATUTE, TORT, STRICT LIABILITY, NEGLIGENCE, OR OTHERWISE.

Banner Engineering Corp. reserves the right to change, modify or improve the design of the product without assuming any obligations or liabilities relating to any product previously manufactured by Banner Engineering Corp. Any misuse, abuse, or improper application or installation of this product or use of the product for personal protection applications when the product is identified as not intended for such purposes will void the product warranty. Any modifications to this product without prior express approval by Banner Engineering Corp will void the product warranties. All specifications published in this document are subject to change; Banner reserves the right to modify product specifications or update documentation at any time. Specifications and product information in English supersede that which is provided in any other language. For the most recent version of any documentation, refer to: www.bannerengineering.com.