

0RQB-30Y05S

Isolated DC-DC Converter

The 0RQB-30Y05S is an isolated DC/DC converter providing 25 W of output power from a wide input range (24 V, 48 V, 72 V, 96 V, 110 V typical). Standard features include remote on/off, input under-voltage protection, output over-voltage protection, over current and short circuit protection.

This converter can also provide a 5 V/5 mA auxiliary supply. When a large hold-up capacitor is added, the converter can still work up to 12 ms when the input supply is interrupted. Conformal coated PCB is used for environmental ruggedness.



Key Features & Benefits

- 24 / 48 / 72 / 96 / 110 VDC Input
- 5.1 VDC / 5 A Output
- Reinforced Isolation
- Input Under-Voltage Protection
- High Efficiency
- Output Over-Voltage Protection
- Hold-Up Function
- Over Current and Short Circuit Protection
- Remote ON/OFF
- Over Temperature Protection
- Conformal Coated
- 5V Auxiliary Supply at Primary Side
- Wide Input Range (24 V, 48 V, 72 V, 96 V, 110 V typical)
- Approved to EN 62368-1
- Class II, Category 2, Isolated DC/DC Converter (refer to IPC-9592B)

Applications

- Industrial
- Railway

1. MODEL SELECTION

MODEL NUMBER	OUTPUT VOLTAGE	INPUT VOLTAGE	MAX. OUTPUT CURRENT	MAX. OUTPUT POWER	TYPICAL EFFICIENCY
ORQB-30Y05SG	5.1 VDC	24 / 48 / 72 / 96 / 110 VDC	5 A	25 W	82%

PART NUMBER EXPLANATION

0	R	QB	-	30	Y	05	S	G
Mounting Type	RoHS Status	Series Name		Output Power	Input Range	Output Voltage	Active Logic & HSK Feature	Package Type
Through Hole Mount	RoHS	DOSA Quarter Brick		25 W	24 / 48 / 72 / 96 / 110 V	5.1 V	Active Low, with Baseplate	Tray Package

2. ABSOLUTE MAXIMUM RATINGS

PARAMETER	DESCRIPTION	MIN	TYP	MAX	UNITS
Continuous non-operating Input Voltage		0.5	-	160	V
Remote On/Off		0.3	-	15	V
Thermal Resistance	Baseplate to heatsink, flat greased surface	-	0.24	-	°C/W
	Baseplate to ambient	-	4	-	
Operating Temperature	Temperature measured at the center of the baseplate, full load	-40	-	105	°C
Storage Temperature		-55	-	125	°C
Altitude		-	-	2000	m

NOTE: Ratings used beyond the maximum ratings may cause a reliability degradation of the converter or may permanently damage the device.

3. INPUT SPECIFICATIONS

PARAMETER	DESCRIPTION	MIN	TYP	MAX	UNIT
Operating Input Voltage Range 1	Fully functioning for long term operation.		24		
			48		
		16.8	72	137.5	V
			96		
			110		
Operating Input Voltage Range 2	Fully functioning for 0.1 s operation. Full function is not guaranteed but undamaged for 1 s operation.	12.9	-	16.8	V
		137.5	-	154	
Input Current		-	-	2.5	A
Input Voltage Rising Slope		-	-	2	V/ms
Input Current (no load)		-	100	150	mA
Remote Off Input Current		-	-	40	mA
Input Reflected Ripple Current (pk-pk)	With simulated source impedance of 10 μ H, 5 Hz to 20 MHz. Use two 100 μ F/250 V electrolytic capacitors with ESR = 0.5 R max, at 200 kHz @ 25°C.	-	-	300	mA
Input Reflected Ripple Current (rms)		-	-	100	mA
Under-voltage Turn on Threshold	Lockout turn on	15	15.6	16.2	V
Under-voltage Turn off Threshold	Lockout turn off, non-latching	11.7	12.2	12.7	V
Recommended input fast-acting fuse on system board		-	6	-	A

CAUTION: This converter is not internally fused. An input line fuse must be used in application.

4. OUTPUT SPECIFICATIONS

PARAMETER	DESCRIPTION	MIN	TYP	MAX	UNIT
Output Voltage Set Point		5	5.1	5.2	V
Line Regulation		-	-	10	mV
Load Regulation		-	-	20	mV
Regulation Over Temperature		-	-	±100	mV
Output Current Range		0	-	5	A
Output Ripple and Noise (pk-pk)	With a 100 μ F ceramic and a 100 μ F electrolytic capacitors at output.	-	50	80	mV
Output Ripple and Noise (rms)		-	10	15	mV
Output DC Current Limit	Enter a hiccup mode, non-latching.	5	-	7	A
Turn on Time	Enable from Vin	-	-	1500	ms
	Enable from ON/OFF	-	-	200	
Rise Time		-	25	50	ms
Overshoot at Turn on		-	0	3	%
Undershoot at Turn off		-	0	3	%
Output Capacitance	Typically 50% ceramic and 50% electrolytic capacitors.	200	-	1000	μ F
5V Auxiliary Supply Source Current		-	-	5	mA
Transient Response					
ΔV 50% ~ 75% of Max Load		-	200	250	mV
Settling Time	di/dt = 0.1 A/ μ s, with a 100 μ F ceramic and a 100 μ F electrolytic capacitors near the brick output.	-	0.5	0.75	ms
ΔV 75% ~ 50% of Max Load		-	200	250	mV
Settling Time		-	0.5	0.75	ms

NOTE: All specifications are typical at nominal input, full load at 25°C unless noted.

5. GENERAL SPECIFICATIONS

PARAMETER	DESCRIPTION	MIN	TYP	MAX	UNIT
Efficiency	Vin = 24 V, Iout = 5 A	79	81	-	%
	Vin = 48 V, Iout = 5 A	82	83	-	
	Vin = 72 V, Iout = 5 A	82	83	-	
	Vin = 96 V, Iout = 5 A	82	83	-	
	Vin = 110 V, Iout = 5 A	83	84	-	
Switching Frequency	1st stage	-	140	-	kHz
	2nd stage	-	250	-	
FIT*	Calculated Per IEC 62380 TR 1 (Utec 80-810)	-	176.66	-	
MTBF*	(Vin=24 V, Vo=5.1V, Io=5A, Tac = 50°C, Tae=35°C)	-	5.66	-	Mhours
Dimensions (L x W xH)		2.30 x 1.45 x 0.59			inch
		58.42 x 36.83 x 15.00			mm
Weight		-	62	-	g
Over Temperature Protection		-	125	-	°C
Over Voltage Protection (Static)		-	6.2	-	V
Isolation Characteristics					
Isolation Capacitance		-	-	2200	pF
Isolation Resistance		10M	-	-	ohm
Input to Output		-	-	2250	V
Input to Heatsink		-	-	2250	V
Output to Heatsink		-	-	2250	V

NOTE: All specifications are typical at 25 °C unless otherwise stated.

6. EFFICIENCY DATA

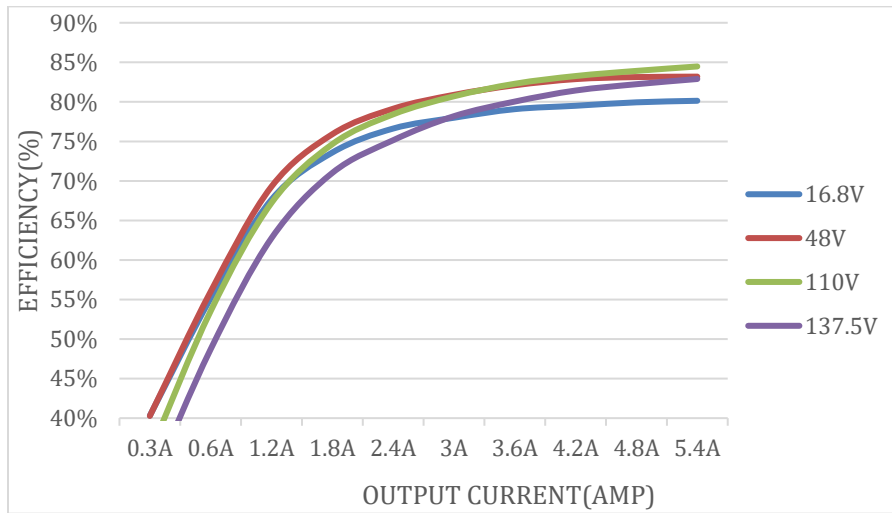

Figure 1. Efficiency



Asia-Pacific +86 755 298 85888
Europe, Middle East +353 61 225 977
North America +1 408 785 5200

7. REMOVE ON/OFF

PARAMETER	DESCRIPTION		MIN	TYP	MAX	UNIT
Signal Low (Unit On)	Active Low	Remote On/Off pin is open, the module is off.	-0.3	-	0.8	V
Signal High (Unit Off)			2.4	-	15	
Current Sink			0	-	1	mA

Recommended Remote On/Off Circuit for Active Low

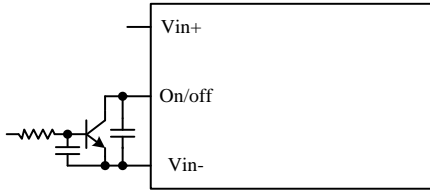

Figure 2. Control with open collector/drain circuit

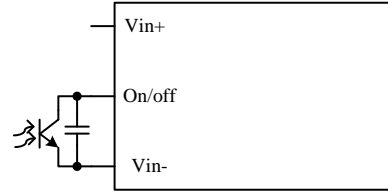

Figure 3. Control with photocoupler circuit

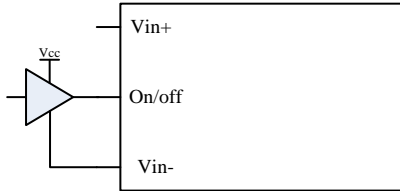

Figure 4. Control with logic circuit

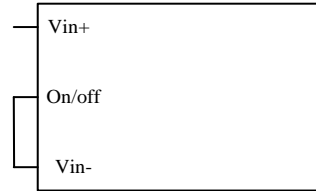

Figure 5. Permanently on

8. RIPPLE AND NOISE WAVEFORM

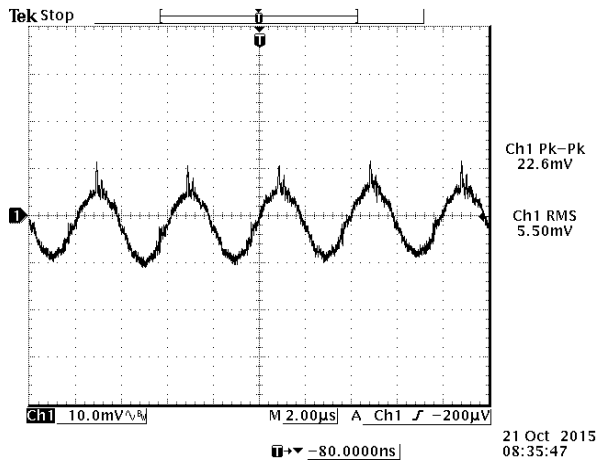

Figure 6.

NOTE: Ripple and noise, 48 VDC input, 5.1 VDC / 5 A output and $T_a = 25^\circ\text{C}$, with 100 μF ceramic capacitor and 100 μF AL. cap at output.

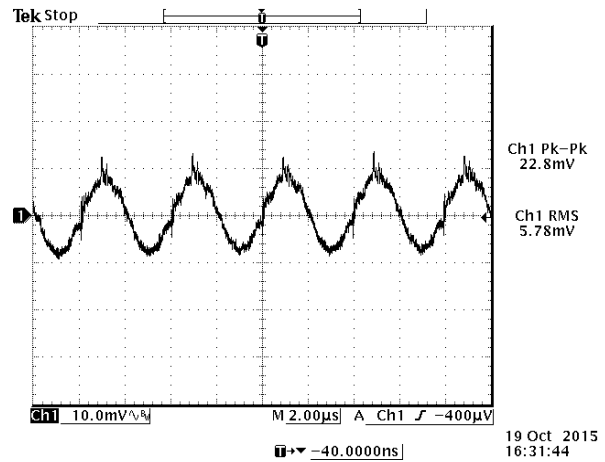

Figure 7.

NOTE: Ripple and noise, 110 VDC input, 5.1 VDC / 5 A output and $T_a = 25^\circ\text{C}$, with 100 μF ceramic capacitor and 100 μF AL. cap at output.

9. INPUT NOISE

Input Reflected Ripple Current

Testing setup:

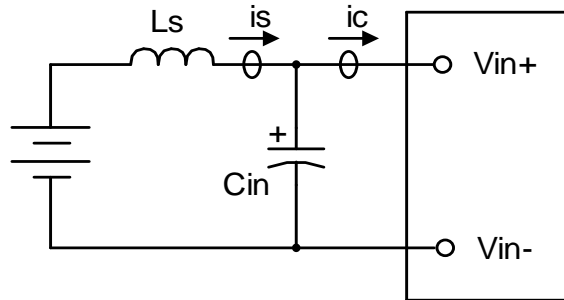

Figure 8.

Notes and values in testing:

Is: Input Reflected Ripple Current

ic: Input Terminal Ripple Current

Ls: Simulated Source Impedance (10 μ H)

Cin: Electrolytic capacitor, should be as closed as possible to the power module to damped ic ripple current and enhance stability.

Recommendation: 2* 10 0 μ F, ESR<0.5R @ 100 kHz, 20 $^{\circ}$ C

Below measured waveforms are based on above simulated and recommended inductance and capacitance.

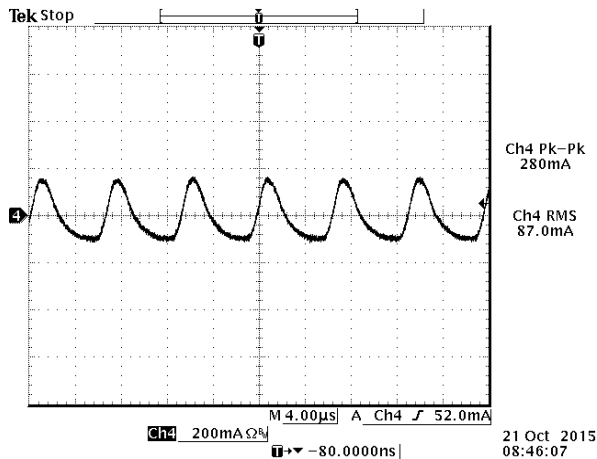

Figure 9. is (input reflected ripple current), AC component

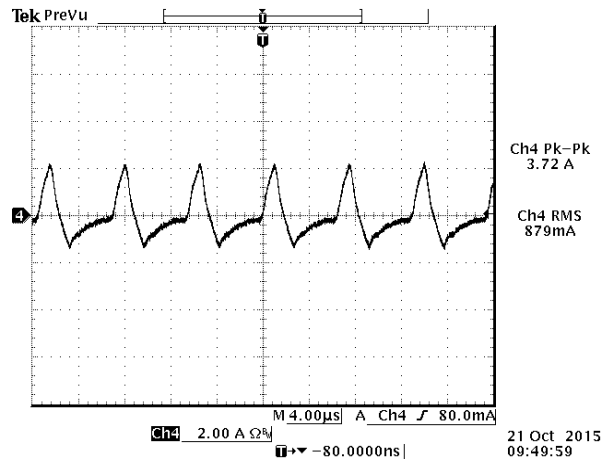

Figure 10. ic (input reflected ripple current), AC component

NOTE: 48 VDC input, 5.1 VDC / 5 A output and Ta = 25 $^{\circ}$ C, with 100 μ F ceramic capacitor and 100 μ F AL. cap at output.

10. TRANSIENT RESPONSE

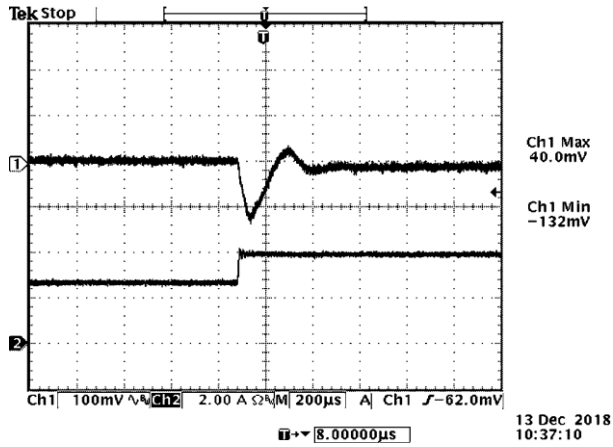

Figure 11. 50%-75% Load Transients at $V_{in} = 48\text{ V} @ T_a = 25^\circ\text{C}$

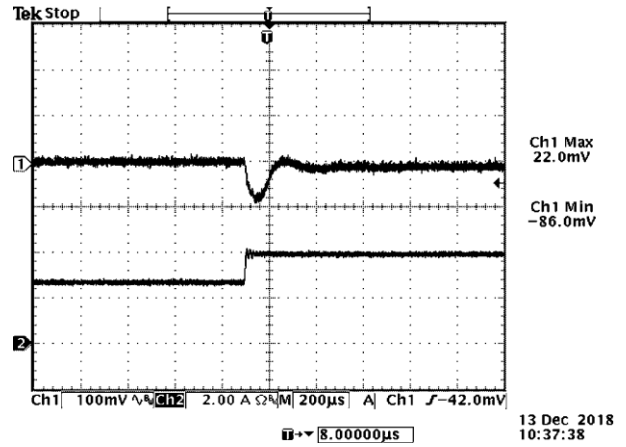

Figure 12. 50%-75% Load Transients at $V_{in} = 110\text{ V} @ T_a = 25^\circ\text{C}$

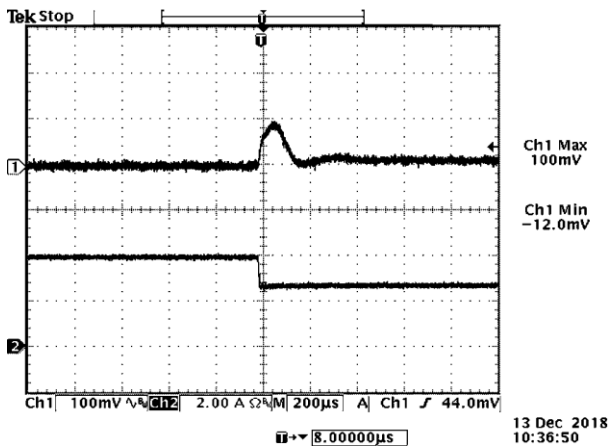

Figure 13. 75%-50% Load Transients at $V_{in} = 48\text{ V} @ T_a = 25^\circ\text{C}$

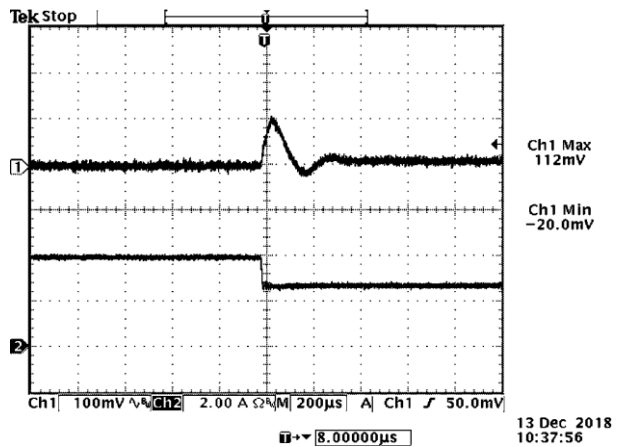

Figure 14. 75%-50% Load Transients at $V_{in} = 110\text{ V} @ T_a = 25^\circ\text{C}$

11. STARTUP & SHUTDOWN

Turn on rise time:

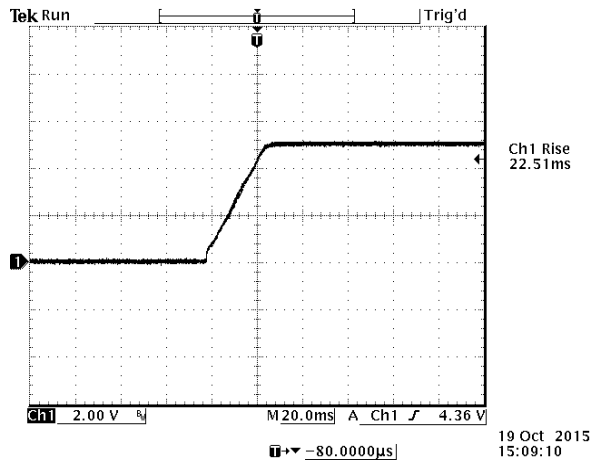

Figure 15. $V_{in} = 48\text{ V}$, $I_o = 5\text{ A}$, $V_o = 5.1\text{ V}$

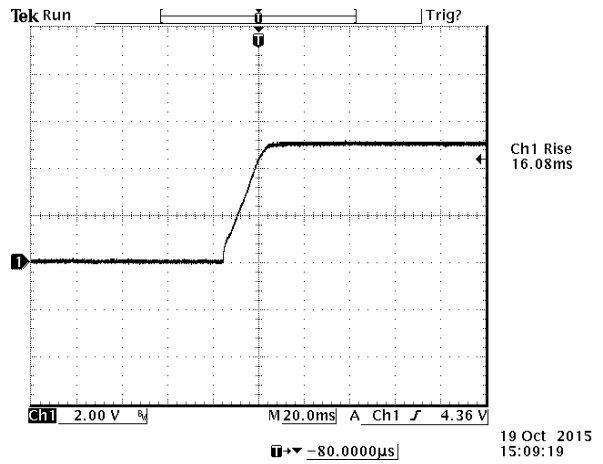

Figure 16. $V_{in} = 110\text{ V}$, $I_o = 5\text{ A}$, $V_o = 5.1\text{ V}$

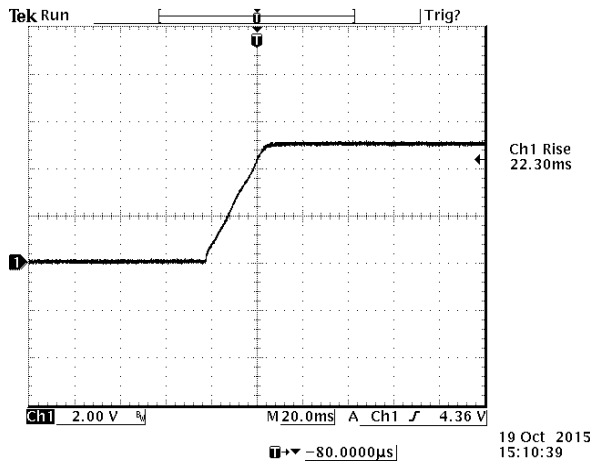

Figure 17. $V_{in} = 48\text{ V}$, $I_o = 5\text{ A}$, $V_o = 5.1\text{ V}$, with $C_{ext} = 1000\text{ }\mu\text{F}$

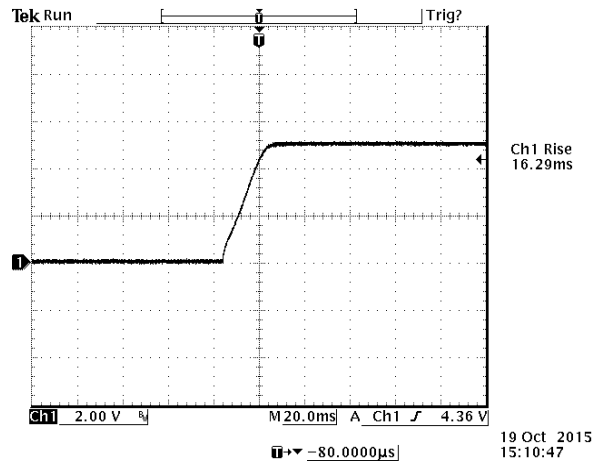

Figure 18. $V_{in} = 48\text{ V}$, $I_o = 5\text{ A}$, $V_o = 5.1\text{ V}$, with $C_{ext} = 1000\text{ }\mu\text{F}$

Turn on delay time:

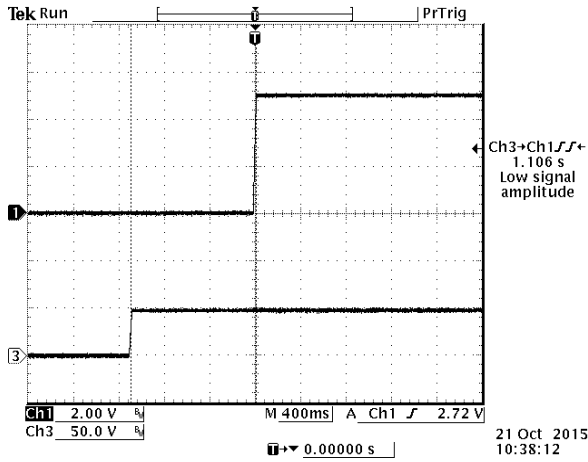

Figure 19. Startup from Vin
 Ch1: Vo
 Ch3: Vin
 Vin = 48 V, Io = 5 A, Vo = 5.1 V

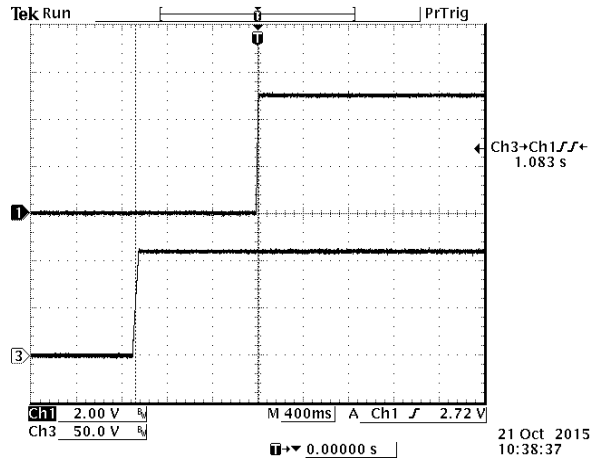

Figure 20. Startup from Vin
 Ch1: Vo
 Ch3: Vin
 Vin = 110 V, Io = 5 A, Vo = 5.1 V

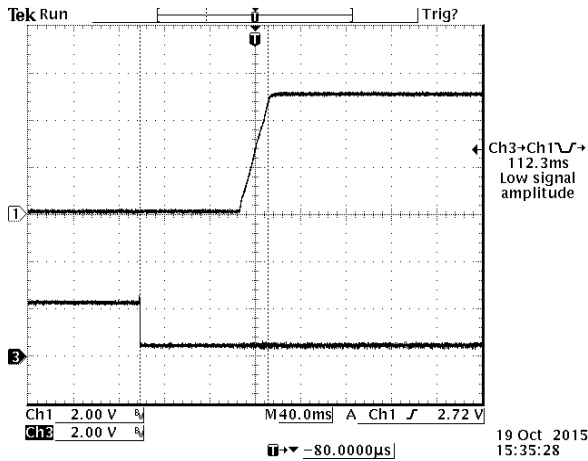

Figure 21. Startup from on/off
 Ch1: Vo
 Ch3: on/off
 Vin = 48 V, Io = 5 A, Vo = 5.1 V

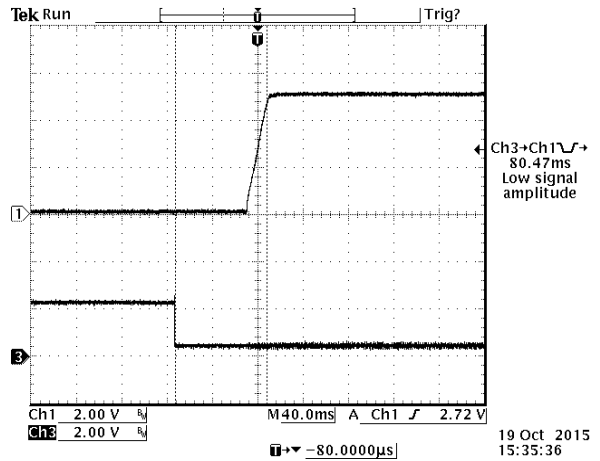

Figure 22. Startup from on/off
 Ch1: Vo
 Ch3: on/off
 Vin = 110 V, Io = 5 A, Vo = 5.1 V

Shutdown:

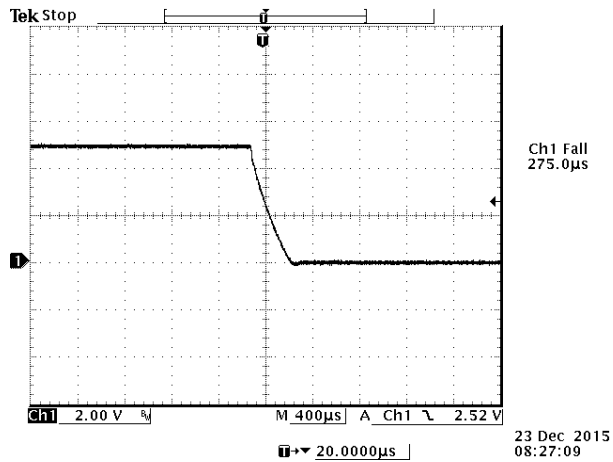

Figure 23. $V_{in} = 48\text{ V}$, $I_o = 5\text{ A}$, $V_o = 5.1\text{ V}$

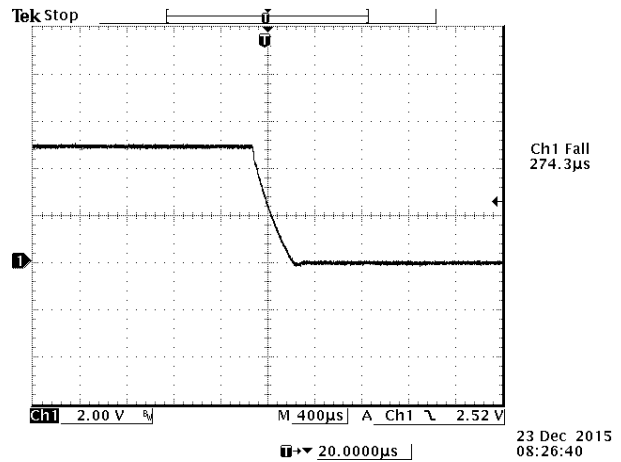

Figure 24. $V_i = 48\text{ V}$, $I_o = 5\text{ A}$, $V_o = 5.1\text{ V}$

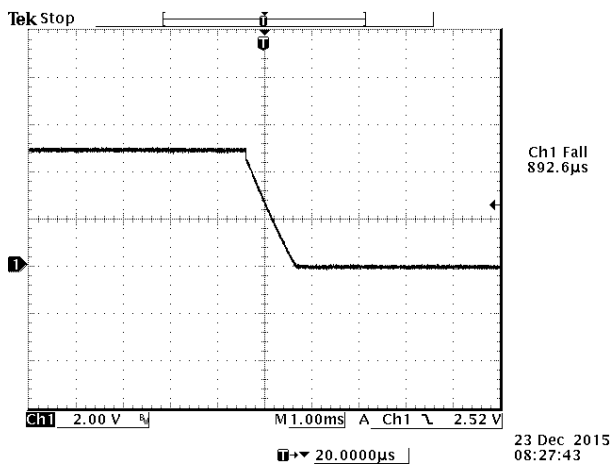

Figure 25. $V_{in} = 48\text{ V}$, $I_o = 5\text{ A}$, $V_o = 5.1\text{ V}$, with $C_{ext} = 1000\text{ }\mu\text{F}$

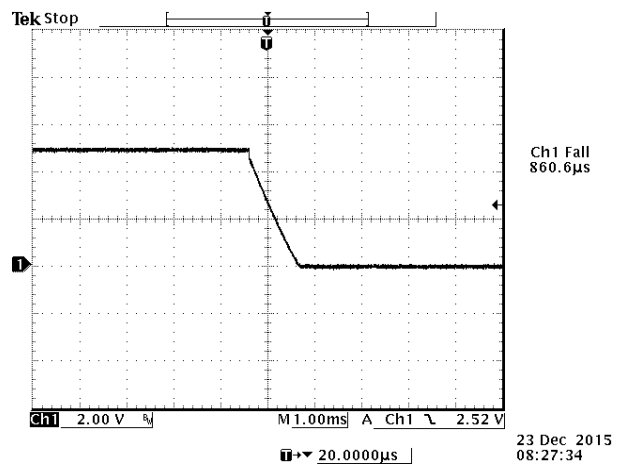

Figure 26. $V_{in} = 48\text{ V}$, $I_o = 5\text{ A}$, $V_o = 5.1\text{ V}$, with $C_{ext} = 1000\text{ }\mu\text{F}$

12. HOLD UP CIRCUIT

PARAMETER	DESCRIPTION	SYMBOL	MIN	TYP	MAX	UNITS
Hold up Capacitor	Working voltage rating should be 200 V. Caution: This capacitor is necessary for both normal and hold up operation.	C_HOLD	220	-	330	μF
Hold up Voltage	Normal operation.	V_HOLD	45	85	154	V
Hold up Time	16.8 - 137.5 V input and all lout range.	T_HOLD	12	-	-	ms

Recommended External Hold up Circuit

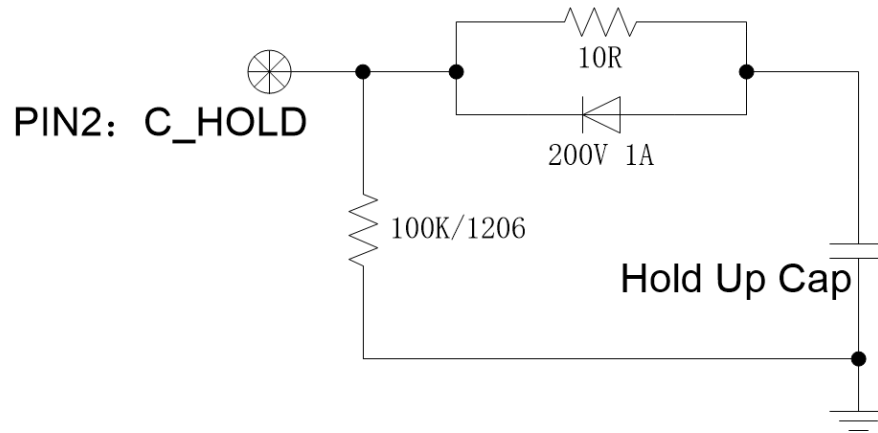

Figure 27.

NOTE: the power of the current-limiting resistance is determined by the rise slope of the input voltage.

13. INPUT UNDER-VOLTAGE LOCKOUT

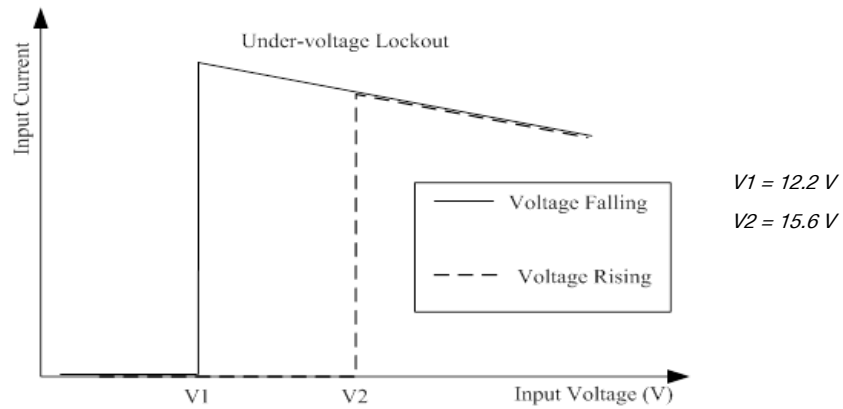

Figure 28. Input under voltage lockout

14. THERMAL DERATING CURVES

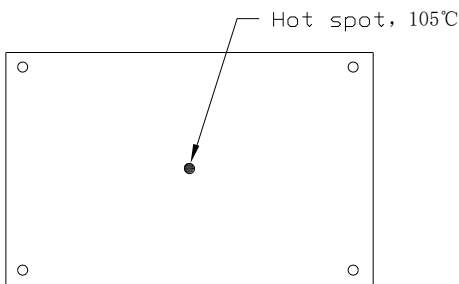

Figure 29. Module top view

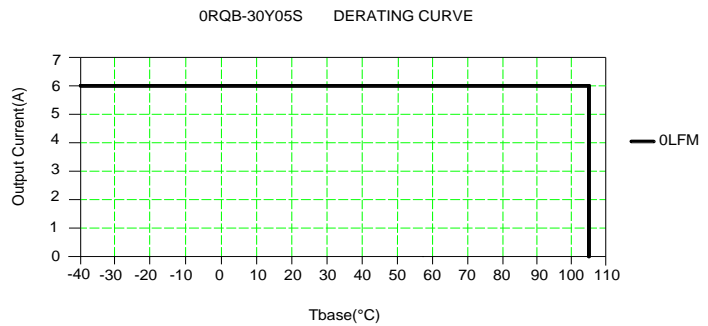

Figure 30. Derating curve

15. SAFETY & EMC

Safety:

safety certificated to EN 62368-1

CE certificated to Low Voltage Directive 2014/35/EU

EMC:

Conductive EMI: EN 55032 class A

Compliance to EN 55032 class A (both peak and average) with the following inductive and capacitive filter

Test Setup:

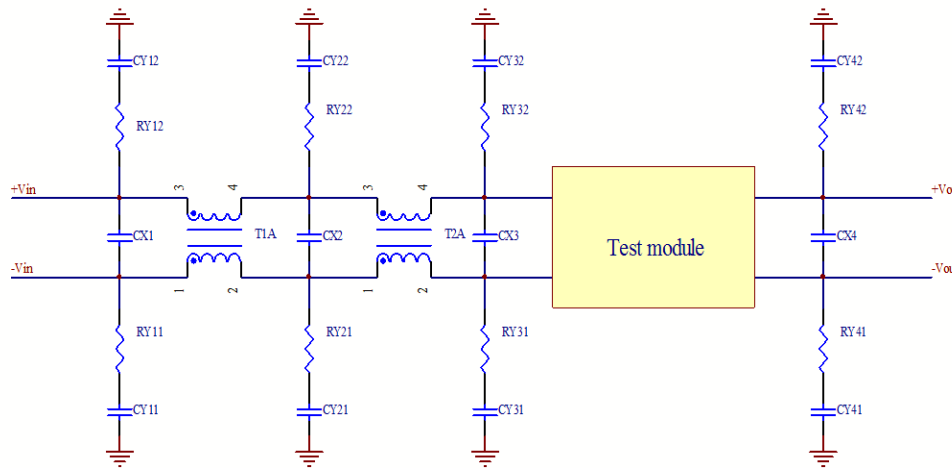

Figure 31.

ITEM	DESIGNATOR	PARAMETER	VENDOR	VENDOR P/N
1	CX1	Cap X2 1uF +/-20% 310VAC	Vishay	BFC233924105
2	CX2	AL-EL CAP 100uF+/-20% 200V -40 to 105C 18X40mm	Nichicon	UPJ2D101MHD
3	CX3	AL-EL CAP 100uF+/-20% 200V -40 to 105C 18X40mm	Nichicon	UPJ2D101MHD
4	CY21	CAP Y2 4700PF +/-20% 250VAC 7.5mm CTRS	MURATA	DE2E3KH472MB3B
5	CY22	CAP Y2 4700PF +/-20% 250VAC 7.5mm CTRS	MURATA	DE2E3KH472MB3B
6	CX4	AL-EL CAP 330UF 20% 100V 100YXH330M-EFC-18*20 Lead Type	NCC	EKY-101ELL331MM20S
7	T1A	5.0uH, 70mOhm, 3.7Amp Max. DIP Common Mode Chokes	ITG Electronics	C20200-06
8	RY21	CHIP RES TKF 0R +/-5% 0.25W 1206	SEI	RMCF1206ZT0R00
9	RY22	CHIP RES TKF 0R +/-5% 0.25W 1206	SEI	RMCF1206ZT0R00
10	T2A,RY12, RY11,CY11, CY12,RY32, RY31,CY32 CY31,RY42,RY41,CY41, CY42	NIL		

Positive:

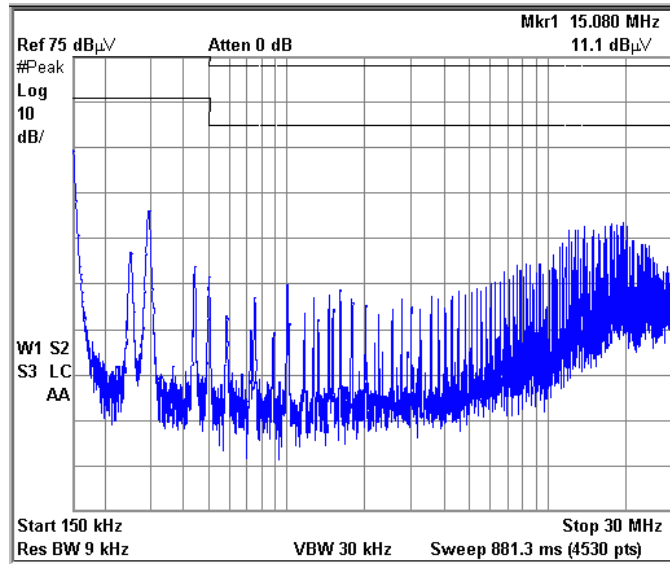

Figure 32. Positive

Negative:

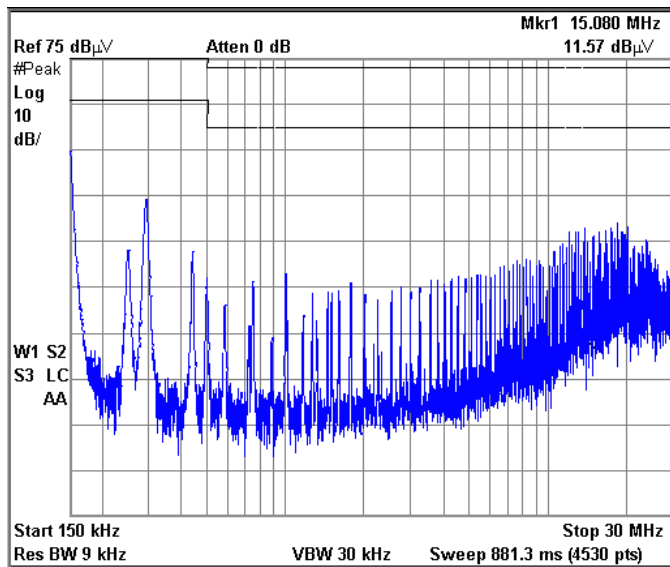

Figure 33. Negative

16. MECHANICAL DIMENSIONS
OUTLINE

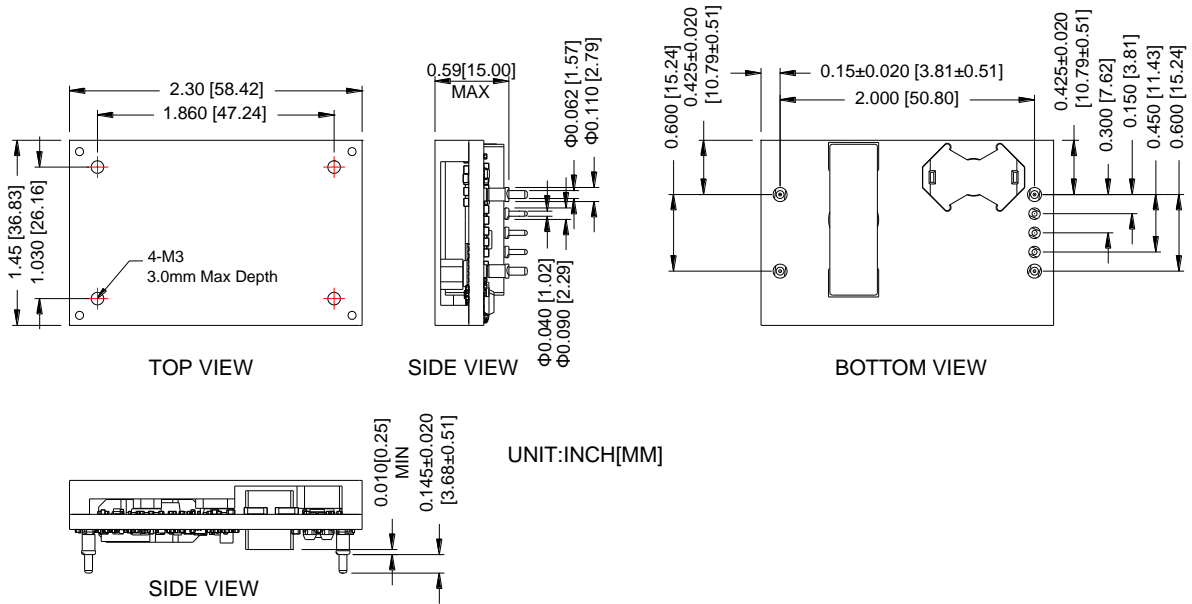

Figure 34. Outline

Note: This module is recommended and compatible with Pb-Free Wave Soldering and must be soldered using a peak solder temperature of no more than 260 °C for less than 5 seconds.

Notes:

- 1) All Pins: Material - Copper Alloy;
Finish - Tin plated.
- 2) Un-dimensioned components are shown for visual reference only.
- 3) All dimensions in inch [mm]; Tolerances: x.xx +/-0.02 inch [0.5 mm]. x.xxx +/-0.010 inch [0.25 mm]. Unless otherwise stated.

PIN DEFINITIONS

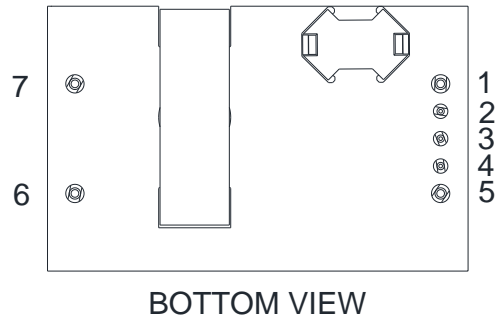

Figure 35. Pins

PIN	FUNCTION
1	Vin(+)
2	C_HOLD
3	ON/OFF
4	V_AUX(5V)
5	Vin(-)
6	Vout(-)
7	Vout(+)

RECOMMENDED PAD LAYOUT

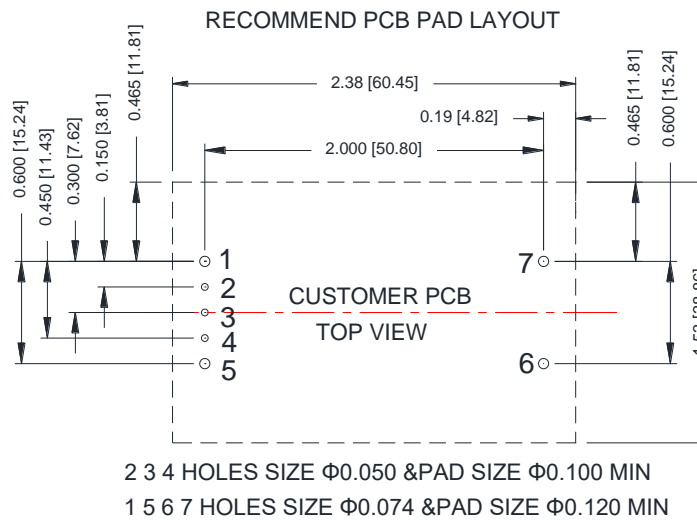

Figure 36. Recommended pad layout

17. REVISION HISTORY

DATE	REVISION	CHANGES DETAIL	APPROVAL
2018-08-09	AA	First release.	S.Wang
2018-09-13	AB	Update MD.	S.Wang
2018-10-10	AC	Update hold-up circuit.	S.Wang
2018-12-13	AD	Update OCP and Under-voltage Turn on Threshold.	S.Wang
2019-06-17	AE	Update the Efficiency of 24V 5A; Add safety certification.	S.Wang
2019-10-24	AF	Add feature reinforced isolation.	S.Wang
2020-10-10	AG	Delete preliminary watermark. Update outline.	XF.Jiang
2021-05-12	AH	Add object ID.	XF.Jiang

For more information on these products consult: tech.support@psbel.com

NUCLEAR AND MEDICAL APPLICATIONS - Products are not designed or intended for use as critical components in life support systems, equipment used in hazardous environments, or nuclear control systems.

TECHNICAL REVISIONS - The appearance of products, including safety agency certifications pictured on labels, may change depending on the date manufactured. Specifications are subject to change without notice.



tech.support@psbel.com
belfuse.com/power-solutions

