

Female cordset V1-W-15M-PUR

- Degree of protection IP68 / IP69
- Resistant to microbes and hydrolysis
- Halogen-free
- Specific design protects against loosening and inaccurate installation

Female cordset single-ended M12 angled A-coded, 4-pin, PUR cable grey



Dimensions

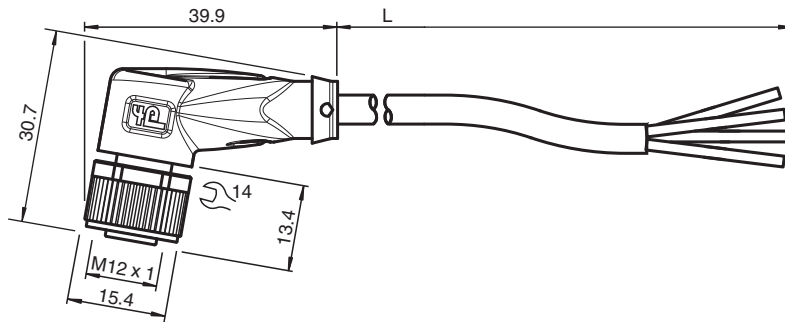

Technical Data

General specifications

Connector 1	
Connection	socket
Construction type	M12
Style	angled
Locking	screw connection
Number of pins	4
Coding	A-coded
Connector 2	
Connection	cable end

Electrical specifications

Operating voltage	U_B	max. 250 V AC/DC
Operating current	I_B	max. 4 A

Conformity

Degree of protection	EN 60529
Plug connection	connector M12 x 1 : IEC 61076-2-101
Halogen-free	IEC 60754-1

Release date: 2022-03-20 Date of issue: 2022-03-20 Filename: 195615_eng.pdf

Refer to "General Notes Relating to Pepperl+Fuchs Product Information".

Pepperl+Fuchs Group
www.pepperl-fuchs.com

USA: +1 330 486 0001
fa-info@us.pepperl-fuchs.com

Germany: +49 621 776 1111
fa-info@de.pepperl-fuchs.com

Singapore: +65 6779 9091
fa-info@sg.pepperl-fuchs.com

PEPPERL+FUCHS

Technical Data

Ambient conditions		
Ambient temperature		
Plug connector		-40 ... 90 °C (-40 ... 194 °F)
Cable, fixed		-40 ... 80 °C (-40 ... 176 °F)
Cable, flexing		-25 ... 80 °C (-13 ... 176 °F)
Pollution degree		3
Mechanical specifications		
Plug connector		
Tightening torque		0.6 Nm
Loosening protection		available
Tool installation		straight knurling and hexagon nut SW = 14 mm
Mating cycles		min. 100
Degree of protection		IP68 / IP69
Cable		according to IEC/EN 60228 (DIN VDE 0295) class 5
Sheath diameter		4.8 mm
Bending radius		> 10 x cable diameter, moving > 8 x cable diameter, fixed
Sheath stripping force		max. 60 N / 500 mm
Sheath color		grey (similar to RAL 7001)
Number of cores		4
Core cross section		0.34 mm ²
Cores color		Core 1: brown Core 2: white Core 3: blue Core 4: black
Core construction		19 x 0.15 mm Ø
Length	L	15 m
Cable code		Li 9Y 11YM 4 x 0.34
Drag chain suitability		
Drag chain cycles		max. 50 / day
Motion velocity		max. 0.3 m/s
Material		
Halogen-free		yes
Plug connector		
Screw connection		Zinc diecast, nickel-plated
Body		TPU, black
Seal		FKM
Contact surface		Au
Flammability		V-2
Cable		
Sheathing		PUR based on polyether
Core insulation		PP
Chemical resistance		good
Microbial resistance		yes
Hydrolysis resistance		yes

Release date: 2022-03-20 Date of issue: 2022-03-20 Filename: 195615_eng.pdf

Refer to "General Notes Relating to Pepperl+Fuchs Product Information".

Pepperl+Fuchs Group
www.pepperl-fuchs.com

USA: +1 330 486 0001
fa-info@us.pepperl-fuchs.com

Germany: +49 621 776 1111
fa-info@de.pepperl-fuchs.com

Singapore: +65 6779 9091
fa-info@sg.pepperl-fuchs.com





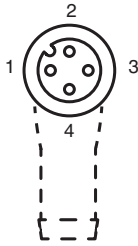

 PEPPERL+FUCHS

Connection Assignment



1	⌋	BN
2	⌋	WH
3	⌋	BU
4	⌋	BK

Accessories

	MH V1-SCREWDRIVER	torque screwdriver (0.6 Nm)
	MH V1-BIT M12	plug-in cap M12
	V1/V3-LABELHOLDER	Label holder
	V1/V3-LABEL	Label plate
	MH V1-Holder	Modular universal holder for M12 connectors
	V1-CLIP	Unlocking protector for M12 connector
	V1-MARKING-RING-COLOR	Marking rings for M12 connectors, various colors

Release date: 2022-03-20 Date of issue: 2022-03-20 Filename: 195615_eng.pdf