



10 dB Fixed Attenuator, 2.92mm Male to 2.92mm Female Passivated Stainless Steel Body Rated to 1 Watt Up to 40 GHz

RF Fixed Attenuators Technical Data Sheet

PE7088-10

Features

- Bidirectional
- DC to 40 GHz Frequency Range
- Attenuation 10±1 dB
- Max Power 1 Watts (CW)
- VSWR < 1.4:1

Applications

- Instrumentation
- Precision measurements
- Prototyping and characterization
- Production systems

Description

Pasternack carries a wide range of fixed attenuators with a broad selection of attenuation levels, frequency ranges, and power dissipation ranges. RF microwave attenuators (also known as RF pads) lower the amplitude of a signal (attenuate) a known amount and can be used in a wide variety of applications. These attenuator pads are used when a signal needs to be reduced to protect measurement equipment or other circuitry, to extend the range of power meters and amplifiers, and to impedance match circuits by reducing the VSWR seen by adjacent components. RF attenuators can prevent signal overload in amplifiers, receivers and detectors, adjusting the signal level to a range that is optimal.

Few RF components are as commonly used as fixed coaxial attenuators, and Pasternack carries one of the largest in-stock varieties and ships them same day. The 10 dB Fixed Attenuator PE7088-10 is rated to 1 Watt and operates from DC to 40 GHz. The versatile coaxial package uses 2.92mm male to 2.92mm female connectors and is also REACH and RoHS compliant.

Electrical Specifications

Description	Minimum	Typical	Maximum	Units
Frequency Range	DC		40	GHz
Impedance		50		Ohms
Nominal Attenuation		10		dB
VSWR			1.4:1	
Input Power, CW derated linearly to .1W at +125°C			1	Watts

Specifications by Frequency

Description	F1	F2	F3	F4	F5	Units
Range	DC to 18	18 to 26.5	26.5 to 40			GHz
VSWR, Max	1.3:1	1.4:1	1.4:1			
Attenuation Accuracy, Typ	±0.6	±0.6	±1			dB

Click the following link (or enter part number in "SEARCH" on website) to obtain additional part information including price, inventory and certifications: [10 dB Fixed Attenuator, 2.92mm Male to 2.92mm Female Passivated Stainless Steel Body Rated to 1 Watt Up to 40 GHz PE7088-10](#)



10 dB Fixed Attenuator, 2.92mm Male to 2.92mm Female
 Passivated Stainless Steel Body Rated to 1 Watt Up to 40 GHz

RF Fixed Attenuators Technical Data Sheet

PE7088-10

Mechanical Specifications

Size

Length	0.87 in [22.1 mm]
Width/Diameter	0.312 in [7.92 mm]
Weight	0.013 lbs [5.9 g]
Body Material and Plating	Passivated Stainless Steel

Configuration

Design	Fixed, Bidirectional
Package Style	Connectorized Module

Connectors

Description	Connector 1	Connector 2
Type	2.92mm Male	2.92mm Female
Contact Material and Plating	Beryllium Copper, Gold	Beryllium Copper, Gold
Contact Plating Specification	MIL-PRF-39012	MIL-PRF-39012
Coupling Nut Material and Plating	Passivated Stainless Steel	
Hex Size	5/16 Inch	
Torque	8 in-lbs 0.9 Nm	
Body Material and Plating	Passivated Stainless Steel	Passivated Stainless Steel

Mechanical Specification Notes:
 The connectors use high temperature plastic bead dielectric.

Environmental Specifications

Temperature

Operating Range	-55 to +125 deg C
-----------------	-------------------

Compliance Certifications (visit www.Pasternack.com for current document)

RoHS Compliant	
REACH Compliant	12/17/2015

Plotted and Other Data

Notes:

Click the following link (or enter part number in "SEARCH" on website) to obtain additional part information including price, inventory and certifications: [10 dB Fixed Attenuator, 2.92mm Male to 2.92mm Female Passivated Stainless Steel Body Rated to 1 Watt Up to 40 GHz PE7088-10](#)



10 dB Fixed Attenuator, 2.92mm Male to 2.92mm Female
Passivated Stainless Steel Body Rated to 1 Watt Up to 40 GHz

RF Fixed Attenuators Technical Data Sheet

PE7088-10

Typical Performance Data

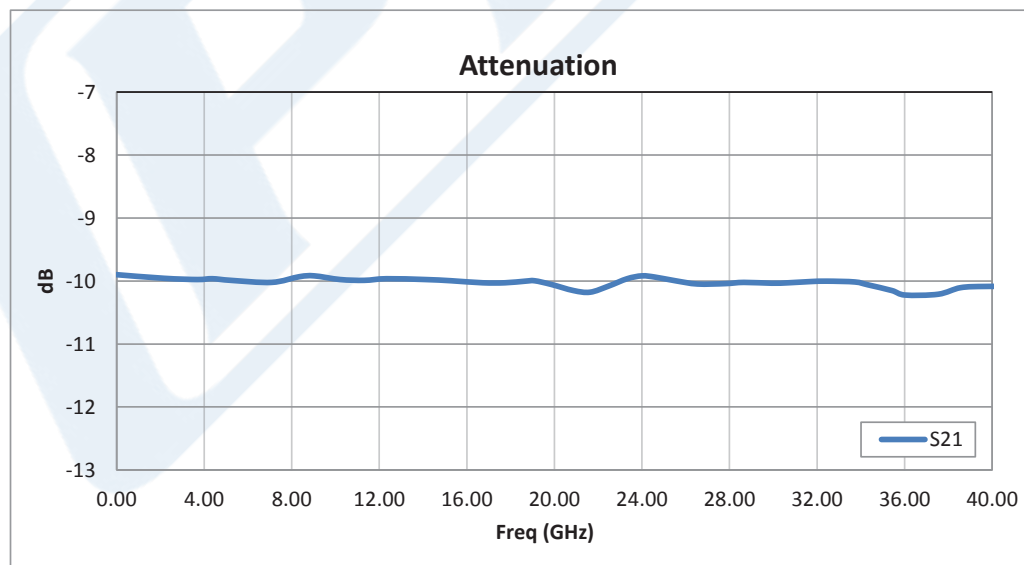

Click the following link (or enter part number in "SEARCH" on website) to obtain additional part information including price, inventory and certifications: [10 dB Fixed Attenuator, 2.92mm Male to 2.92mm Female Passivated Stainless Steel Body Rated to 1 Watt Up to 40 GHz PE7088-10](#)





10 dB Fixed Attenuator, 2.92mm Male to 2.92mm Female
Passivated Stainless Steel Body Rated to 1 Watt Up to 40 GHz

RF Fixed Attenuators Technical Data Sheet

PE7088-10

10 dB Fixed Attenuator, 2.92mm Male to 2.92mm Female Passivated Stainless Steel Body Rated to 1 Watt Up to 40 GHz from Pasternack Enterprises has same day shipment for domestic and International orders. Our RF, microwave and millimeter wave products maintain a 99% availability and are part of the broadest selection in the industry.

Click the following link (or enter part number in "SEARCH" on website) to obtain additional part information including price, inventory and certifications: [10 dB Fixed Attenuator, 2.92mm Male to 2.92mm Female Passivated Stainless Steel Body Rated to 1 Watt Up to 40 GHz PE7088-10](http://www.pasternack.com/10db-fixed-2.92mm-male-2.92mm-female-1-watt-attenuator-pe7088-10-p.aspx)

URL: <http://www.pasternack.com/10db-fixed-2.92mm-male-2.92mm-female-1-watt-attenuator-pe7088-10-p.aspx>

PE7088-10 CAD Drawing

10 dB Fixed Attenuator, 2.92mm Male to 2.92mm Female Passivated
Stainless Steel Body Rated to 1 Watt Up to 40 GHz

P/N	ATTEN.
PE7088-0	0 dB
PE7088-1	1 dB
PE7088-2	2 dB
PE7088-3	3 dB
PE7088-4	4 dB
PE7088-5	5 dB
PE7088-6	6 dB
PE7088-7	7 dB
PE7088-8	8 dB
PE7088-9	9 dB
PE7088-10	10 dB
PE7088-12	12 dB
PE7088-15	15 dB
PE7088-20	20 dB
PE7088-30	30 dB

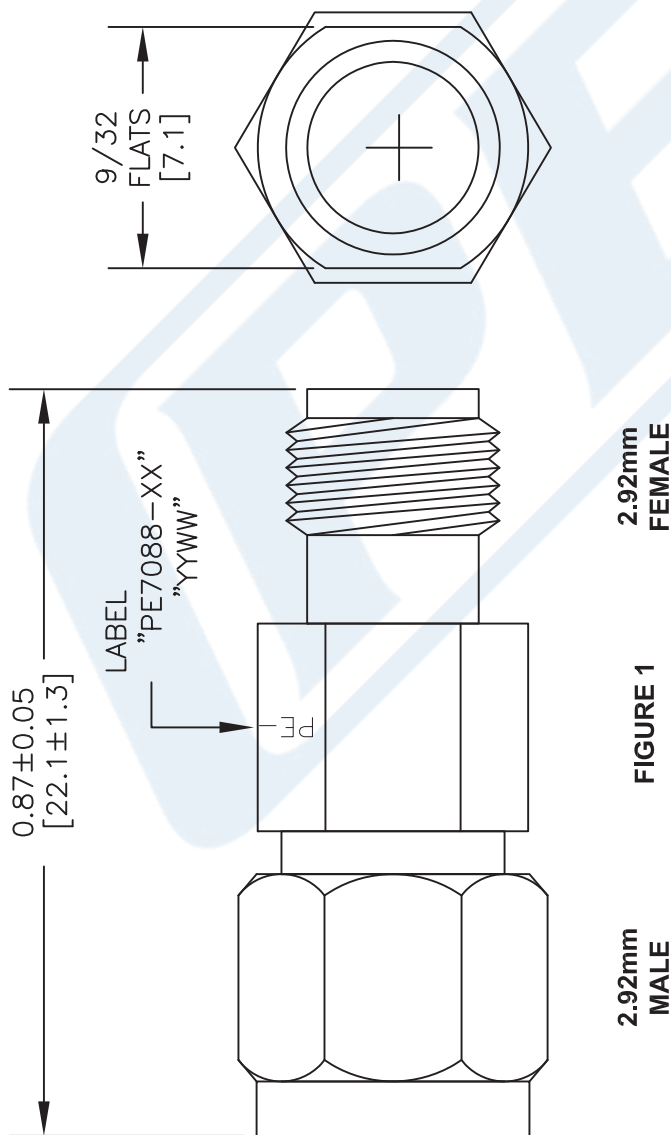

2.92mm
FEMALE

FIGURE 1

2.92mm
MALE

STANDARD TOLERANCES
.X ±0.03
.XX ±0.010
.XXX ±0.005

*STANDARD TOLERANCES APPLY ONLY TO DIMENSIONS IN INCHES

NOTES:
 1. UNLESS OTHERWISE SPECIFIED ALL DIMENSIONS ARE NOMINAL.
 2. ALL SPECIFICATIONS ARE SUBJECT TO CHANGE WITHOUT NOTICE AT ANY TIME.
 3. DIMENSIONS ARE IN INCHES [mm].

DWG TITLE
PE7088

FSCM NO. 53919

CAD FILE 022916

SCALE N/A

SIZE A

3045

PE PASTERNAK®
 THE ENGINEER'S RF SOURCE
 Pasternack Enterprises, Inc.
 P.O. Box 16759 | Irvine | CA | 92623
 Phone: (949) 261-1920 | Fax: (949) 261-7451
 Website: www.pasternack.com | E-Mail: sales@pasternack.com