



**SPX2700/01/02**

**700mA Low Dropout Voltage Regulators  
With Shutdown  
(PRELIMINARY INFORMATION)**

**FEATURES**

- Output Current 700mA at 3.3V and 5V
- Internal Short Circuit Current Limit
- Dropout Voltage 0.5V at 700mA Output
- Extremely Tight Load and Line Regulation
- Very Low Temperature Coefficient
- Mirror Image Insertion Protection
- Unregulated DC Input Can Withstand -20V Reverse Battery and +60V Positive Transients
- Direct Replacement For LM2937 Socket

**APPLICATIONS**

- Battery Powered Systems
- Cordless Telephones
- Automotive Electronics
- Portable/ Palm Top / Notebook Computers
- Portable Consumer Equipment
- Portable Instrumentation
- SMPS Post-Regulator
- Voltage Reference

**PRODUCT DESCRIPTION**

The SPX2700/01/02 are a low power positive voltage regulators. The SPX2700/01/02 offers 700mA output current with a dropout voltage of only 0.5V and over temperature dropout is up to 1V. The quiescent current is 10mA at differential output of 5V and output current of 700mA. A higher quiescent current can exist when the device is in dropout mode ( $V_{IN} - V_{OUT} \leq 3V$ ).

The regulator will automatically shut down to protect both the internal circuits and the load. This device also features short circuit and thermal overload protection.

The SPX2700/01/02 is offered in 3 and 5 pin TO-220, TO-263 and 3-pin SOT-223 packages compatible with other 5V and 3.3V regulators, TO-263 and 3-pin SOT-223. The device is offered in standard output voltages of 5V and 3.3V as well as in adjustable output regulator.

**PIN CONNECTIONS**

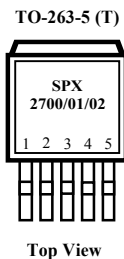

**Five Lead Package Pin Functions:**

- |             |          |
|-------------|----------|
| 1) Error    | Adjust   |
| 2) Input    | Shutdown |
| 3) GND      | GND      |
| 4) Output   | Input    |
| 5) Shutdown | Output   |

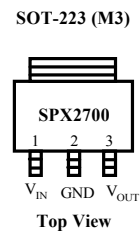
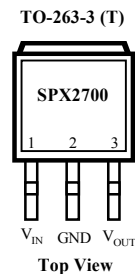
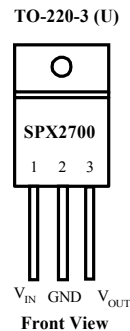

## ABSOLUTE MAXIMUM RATINGS

Power Dissipation.....Internally Limited	Input Supply Voltage      Continuous ..... +12V
Lead Temp. (Soldering, 10 Seconds) ..... 260°C	Transient.....-20V to +60V
Feedback Input Voltage.....-1.5V to +30V	Storage Temperature Range .....-65° to +150°C
Shutdown Input Voltage.....-0.3V to +30V	Operating Junction Temperature Range .....-40°C to +125°C
Error Comparator Output .....-0.3V to +30V	ESD Rating .....2KV Min

**ELECTRICAL CHARACTERISTICS** at  $V_{IN} = V_O + 5V$ ,  $I_O = 700mA$ ,  $C_O = 10 \mu F$ , unless otherwise specified. Limits in **Boldface** type apply over the entire operating temperature range. All other specifications are  $T_A = 25^\circ C$ .

Parameter	Conditions (Note 2)	Typ.	SPX2700/01/02A		SPX2700/01/02		Units
			Min	Max	Min	Max	
<b>3.3V Version</b>							
Output Voltage	-40°C ≤ T <sub>J</sub> ≤ +125°C 1mA ≤ I <sub>L</sub> ≤ 500mA	3.3	3.267	3.333	3.234	3.366	V
			3.3	<b>3.217</b>	<b>3.382</b>	<b>3.185</b>	<b>3.415</b>
<b>5V Version</b>							
Output Voltage	-40°C ≤ T <sub>J</sub> ≤ +125°C 1mA ≤ I <sub>L</sub> ≤ 700mA	5.0	4.950	5.050	4.900	5.100	V
			5.0	<b>4.880</b>	<b>5.120</b>	<b>4.870</b>	<b>5.130</b>
<b>All Voltage Options</b>							
Output Voltage Temperature Coefficient	(Note1)	20		<b>100</b>		<b>150</b>	ppm/°C
Line Regulation (Note 3)	6V ≤ V <sub>IN</sub> ≤ 30V (Note4)	0.03		0.1 0.40		0.20 <b>0.80</b>	%max
Load Regulation (Note 3)	I <sub>L</sub> = 1 to 700 I <sub>L</sub> = 0.1 to 1mA	0.04		0.20 <b>0.30</b>		0.30 <b>0.50</b>	%max
Dropout Voltage (Note 5)	I <sub>L</sub> = 1mA	60		100 <b>150</b>		100 <b>150</b>	mV
	I <sub>L</sub> = 700mA	375		400 <b>500</b>		400 <b>500</b>	
Ground Current	I <sub>L</sub> = 1mA	100		150 <b>180</b>		150 <b>180</b>	μA
		4.5 15		2 <b>2.5</b>		2 <b>2.5</b>	mA
	I <sub>L</sub> = 700mA	20		14 <b>16</b>		14 <b>16</b>	
				20 <b>22</b>		20 <b>22</b>	
Current Limit	V <sub>OUT</sub> = 0			700 <b>800</b>		700 <b>800</b>	mA
Thermal Regulation		0.05		0.2		0.2	%/w
Output Noise, 10Hz to 100kHz I <sub>L</sub> = 100mA	C <sub>L</sub> = 2.2μF C <sub>L</sub> = 33μF	400 200	1.0	<b>0.60</b>	1.0	<b>0.60</b>	μV V <sub>rms</sub>
<b>Adjustable Versions Only</b>							
Reference Voltage	Over Temperature (Note 6)	1.235	1.210 <b>1.200</b> 1.185	1.260 <b>1.270</b> 1.285	1.200 <b>1.980</b> 1.185	1.270 <b>1.272</b> 1.285	V
Feedback Pin Bias Current		20		40 <b>60</b>		60 <b>80</b>	nA
Reference Voltage Temperature Coefficient	(Note 7)	50					ppm/°C
Feedback Pin Bias Current Temperature Coefficient		0.1					NA/°C

**ELECTRICAL CHARACTERISTICS** at  $V_{IN} = V_O + 5V$ ,  $I_O = 700mA$ ,  $C_O = 22 \mu F$ , unless otherwise specified. Limits in **Boldface** type apply over the entire operating temperature range. All other specifications are  $T_A = 25^\circ C$ .

Parameter	Conditions	Typ.	SPX2700/01/02A		SPX2700/01/02		Units
			Min	Max	Min	Max	
<b>Error Comparator</b>							
Output Leakage Current	$V_{OH} = 30V$	0.01		1.00 <b>2.00</b>		1.00 <b>2.00</b>	$\mu A$
Output Low Voltage	$V_{IN} = 4.5V$ $I_{OL} = 400\mu A$	150		250 <b>400</b>		250 <b>400</b>	mV
Upper Threshold Voltage	(Note 8)	60	40 <b>25</b>		40 <b>25</b>		mV
Lower Threshold Voltage	(Note 8)	75		95 <b>140</b>		95 <b>140</b>	mV
Hysteresis	(Note 8)	15					mV
<b>Shutdown Input</b>							
Input Logic Voltage	Low (Regulator ON) High (Regulator OFF)		<b>2.0</b>	0.7	<b>2.0</b>	0.7	V
Shutdown Pin Input Current	$V_S = 2.4V$	30		50 <b>100</b> 600 <b>750</b>		90 <b>150</b> 800 <b>1000</b>	$\mu A$
	$V_S = 30V$	450					
Regulator Output Current In Shutdown		3	10 <b>20</b>			15 <b>25</b>	$\mu A$

- Note 1:** Output or reference voltage temperature coefficients defined as the worst case voltage change divided by the total temperature range.
- Note 2:** Unless otherwise specified all limits are guaranteed for  $T_j = 25^\circ C$ ,  $V_{IN} = 6V$ ,  $I_L = 100\mu A$  and  $C_L = 1\mu F$ . Additional conditions for the 8-pin versions are feedback tied to 5V tap and output tied to output sense ( $V_{OUT} = 5V$ ) and  $V_{SHUTDOWN} \leq 0.8V$ .
- Note 3:** Regulation is measured at constant junction temperature, using pulse testing with a low duty cycle. Changes in output voltage due to heating effects are covered under the specification for thermal regulation.
- Note 4:** Line regulation for the SPX2700/01/02 is tested at  $150^\circ C$  for  $I_L = 1 mA$ . For  $I_L = 100\mu A$  and  $T_j = 125^\circ C$ , line regulation is guaranteed by design to 0.2%. See typical performance characteristics for line regulation versus temperature and load current.
- Note 5:** Dropout voltage is defined as the input to output differential at which the output voltage drops 100 mV below its nominal value measured at 1V differential at very low values of programmed output voltage, the minimum input supply voltage of 2V ( 2.3V over temperature) must be taken into account.
- Note 6:**  $V_{REF} \leq V_{OUT} \leq (V_{in} - 1V)$ ,  $2.3 \leq V_{in} \leq 30V$ ,  $100\mu A \leq I_L \leq 250 mA$ ,  $T_j \leq T_{JMAX}$ .
- Note 7:** Comparator thresholds are expressed in terms of a voltage differential at the feedback terminal below the nominal reference voltage measured at 6V input. To express these thresholds in terms of output voltage change, multiply by the error amplifier gain =  $V_{OUT}/V_{REF} = (R1 + R2)/R2$ . For example, at a programmed output voltage of 5V, the Error output is guaranteed to go low when the output drops by  $95 mV \times 5V/1.235 = 384 mV$ . Thresholds remain constant as a percent of  $V_{OUT}$  as  $V_{OUT}$  is varied, with the dropout warning occurring at typically 5% below nominal, 7.5% guaranteed.
- Note 8:**  $V_{SHUTDOWN} \geq 2V$ ,  $V_{IN} \leq 30V$ ,  $V_{OUT} = 0$ , Feedback pin tied to 5V Tap.
- Note 9:** The junction -to-ambient thermal resistance of the TO-92 package is  $180^\circ C/W$  with 0.4" leads and  $160^\circ C/W$  with 0.25" leads to a PC board. The thermal resistance of the 8-Pin DIP package is  $105^\circ C/W$  junction-to-ambient when soldered directly to a PC board. Junction-to-ambient thermal resistance for the SOIC (S) package is 166

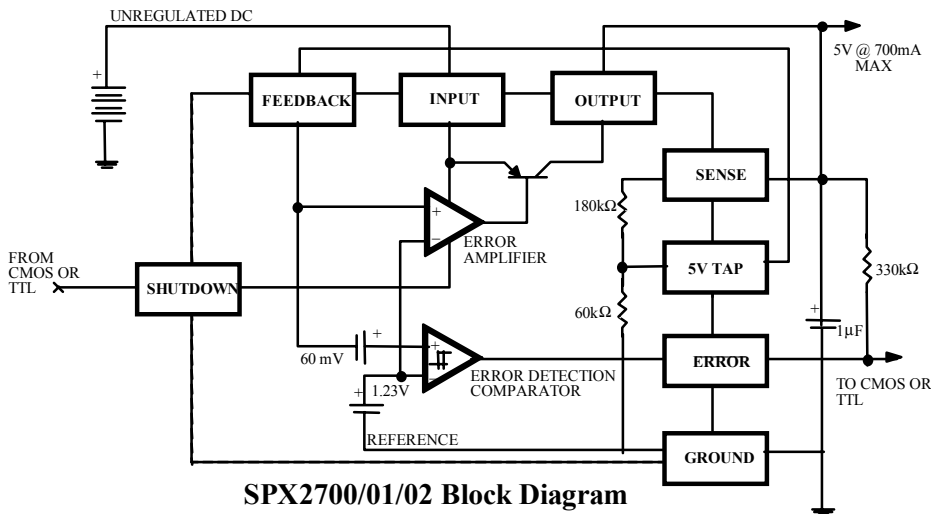

## APPLICATION HINTS

### EXTERNAL CAPACITORS

The stability of the SPX2700/01/02 requires a 10µF or greater capacitor between output and ground. Oscillation could occur without this capacitor. Most types of tantalum or aluminum electrolytic works fine here. For operations below -25°C solid tantalum is recommended since the many aluminum types have electrolytes that freeze at about -30°C. The ESR of about 5Ω or less and resonant frequency above 500 kHz are the most important parameters in the value of the capacitor. The capacitor value may be increased without limit.

At lower values of output current, less output capacitance is required for stability. For the currents below 10mA the value of the capacitor can be reduced to 22µF and 0.15µF for 1mA. More output capacitance is needed for the 8-pin version at voltages below 5V since it runs the error amplifier at lower gain. At worst case 22µF or greater must be used for the condition of 750mA load at 1.23V output.

The SPX2700/01/02, unlike other low dropout regulators will remain stable and in regulation with no load in addition to the internal voltage divider. This feature is especially important in applications like CMOS RAM keep-alive. When setting the output voltage of the SPX2700/01/02 version with external resistors, a minimum load of 5mA is recommended. If there is more than 10 inches of wire between the input and the AC filter capacitor or if a battery is used as the input then a 1µA tantalum or aluminum electrolytic capacitor should be placed from the input to the ground.

### ERROR DETECTION COMPARATOR OUTPUT

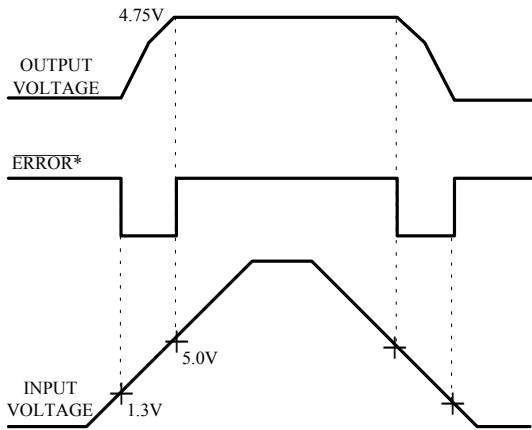

\* See Application Info.

Figure 1. ERROR Output Timing

The Comparator produces a logic low output whenever the SPX2700/01/02 output falls out of regulation by more than around 5%. This is around 75mV offset divided by the 1.235 reference voltage. This trip level remains 5% below normal regardless of the programmed output voltage of the regulator. Figure 1 shows the timing diagram depicting the ERROR signal and the regulator output voltage as the SPX2700/01/02 input is ramped up and down. The ERROR signal becomes low at around 1.3V input, and goes

high around 5V input (input voltage at which  $V_{out} = 4.75$ ). Since the SPX2700/01/02's dropout voltage is load dependent, the input voltage trip point (around 5V) will vary with the load current. The output voltage trip point (approx. 4.75V) does not vary with load. The error comparator has an open-collector output, which requires an external pull-up resistor. Depending on the system requirements the resistor may be returned to 5V output or other supply voltage. In determining the value of this resistor, note that the output is rated to sink 250µA, this value adds to battery drain in a low battery condition. Suggested values range from 100K to 1MΩ. If the output is unused this resistor is not required.

### PROGRAMMING THE OUTPUT VOLTAGE OF SPX2700/01/02

The SPX2700/01/02 may be programmed for any output voltage between its 1.235V reference and its 30V maximum rating. As seen in Figure 2, an external pair of resistors is required. Refer to the below equation for the programming of the output voltage:

$$V_{OUT} = V_{REF} \times (1 + R_1/R_2) + I_{FB}R_1$$

The  $V_{REF}$  is 1.235 and  $I_{FB}$  is the feedback bias current, nominally -20 nA. The minimum recommended load current of 1µA forces an upper limit of 1.2 MΩ on value of  $R_2$ . If no load is presented the  $I_{FB}$  produces an error of typically 2% in  $V_{OUT}$ , which may be eliminated at room temperature by trimming  $R_1$ . To improve the accuracy choose the value of  $R_2 = 100k$  this reduces the error by 0.17% and increases the resistor program current by 12µA. Since the SPX2700/01/02 typically draws 100µA at no load with SHUTDOWN open-circuited this is a small price to pay

### REDUCING OUTPUT NOISE

It may be an advantage to reduce the AC noise present at the output. One way is to reduce the regulator bandwidth by increasing the size of the output capacitor. This is the only way that noise can be reduced on the 3 lead SPX2700/01/02 but is relatively inefficient, as increasing the capacitor from 1µF to 220µF only decreases the noise from 430µV to 160µV<sub>RMS</sub> for a 100 kHz bandwidth at 5V output. Noise could also be reduced fourfold by a bypass capacitor across  $R_1$ , since it reduces the high frequency gain from 4 to unity. Pick

$$C_{BYPASS} \cong 1 / 2\pi R_1 \times 200 \text{ Hz}$$

or choose 0.01µF. When doing this, the output capacitor must be increased to 3.3µF to maintain stability. These changes reduce the output noise from 430µV to 100µV<sub>RMS</sub> for a 100 kHz bandwidth at 5V output. With the bypass capacitor added, noise no longer scales with output voltage so that improvements are more dramatic at higher output voltages.

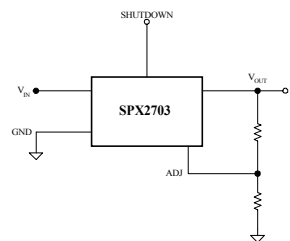
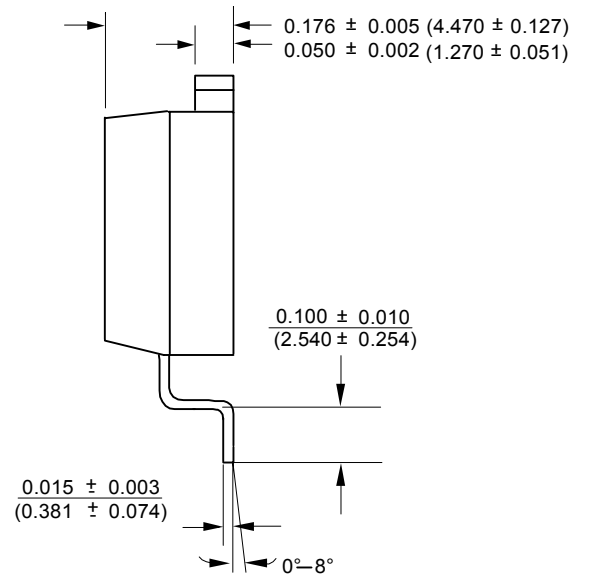
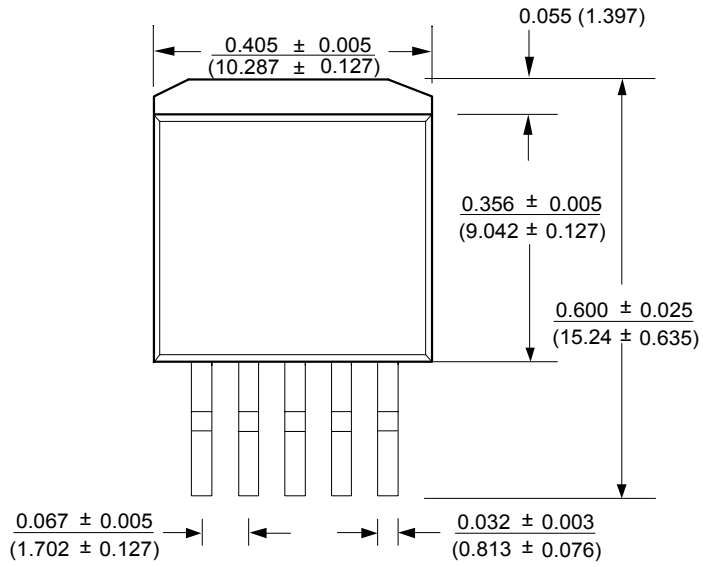
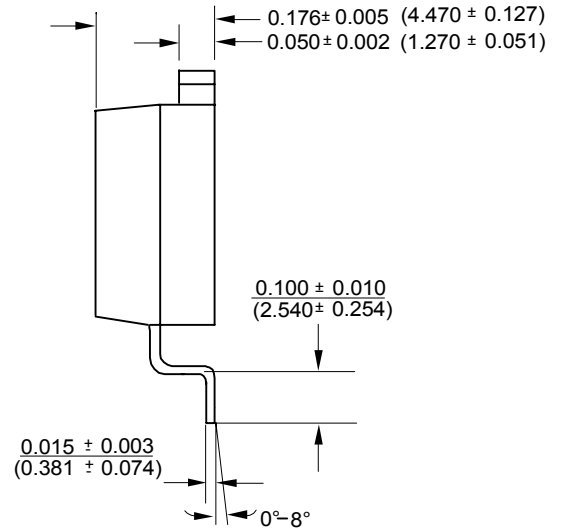
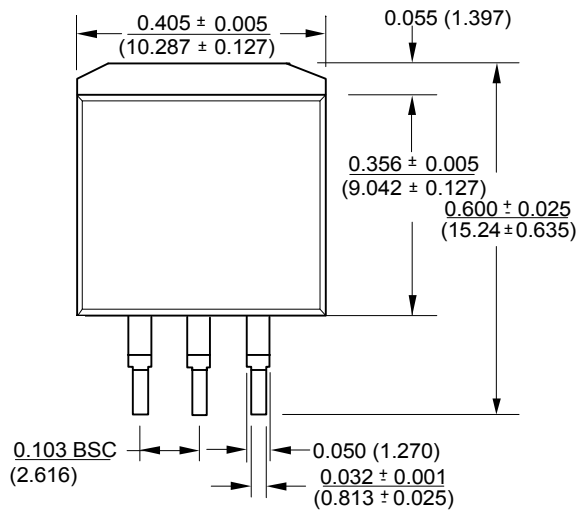

Fig.2 Adjustable Voltage Regulator

TO-263-5L (T)



TO-263-3L (T)



TO-220-3L (U)

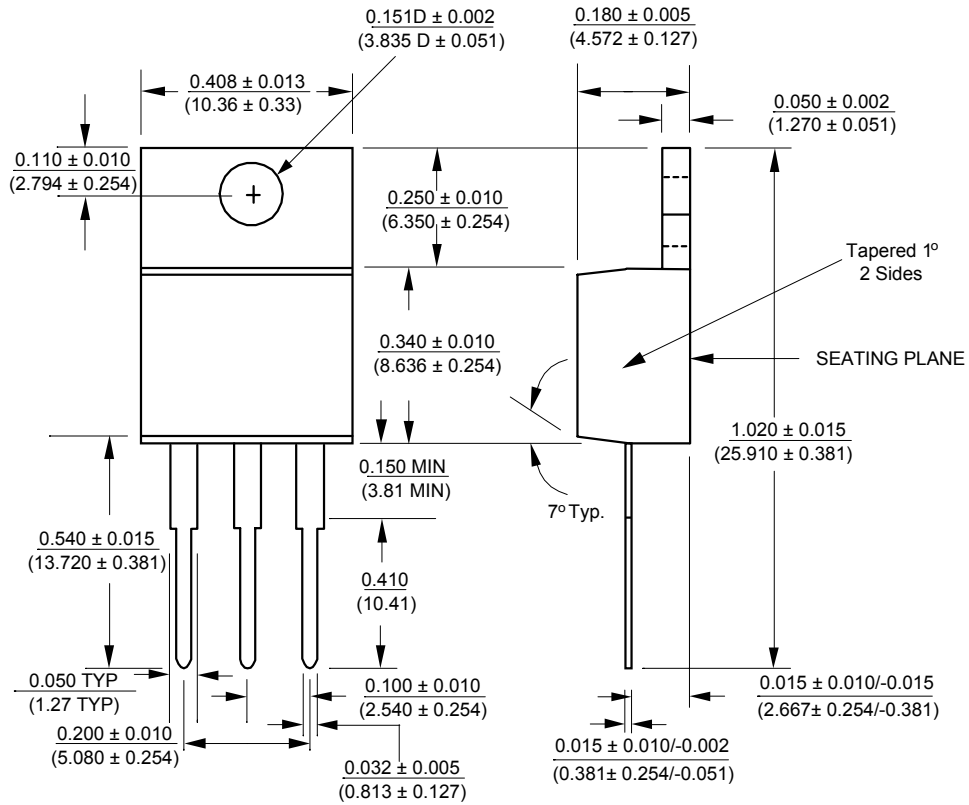

TO-220-5L (U)

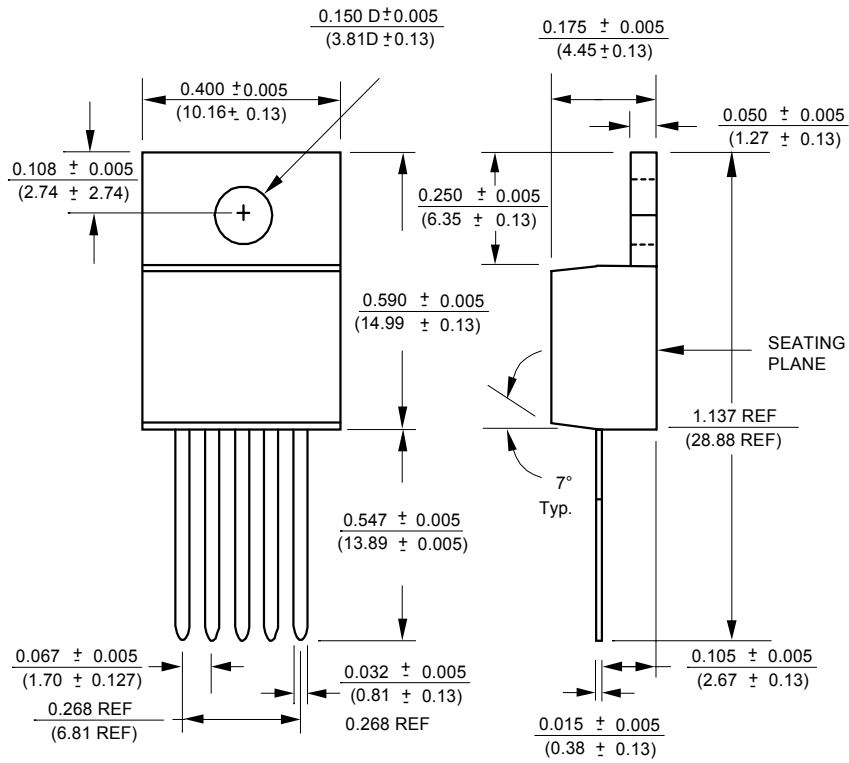



SOT-223-3L (M3)

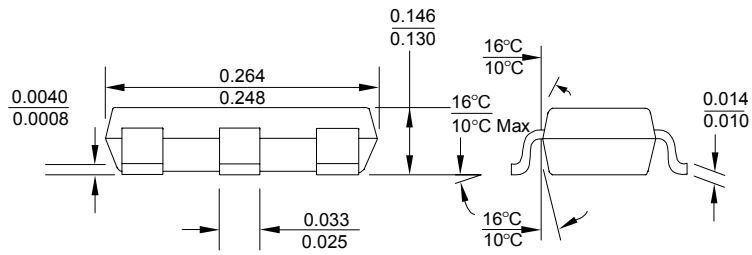
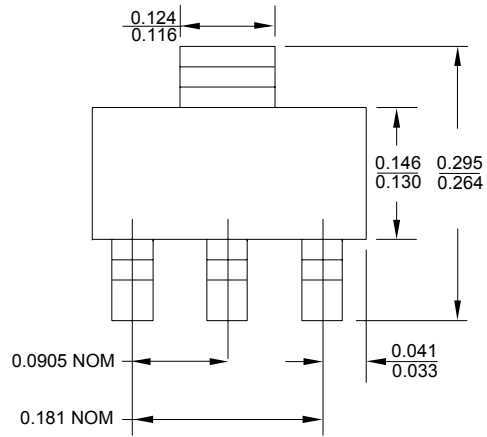

**ORDERING INFORMATION**

<b>Ordering No.</b>	<b>Precision</b>	<b>Output Voltage</b>	<b>Packages</b>
SPX2700M3-3.3	2%	3.3V	3 Lead TO-223
SPX2700M3-5.0	2%	5.0V	3 Lead TO-223
SPX2700AM3-3.3	1%	3.3V	3 Lead TO-223
SPX2700AM3-5.0	1%	5.0V	3 Lead TO-223
SPX2700T3-3.3	2%	3.3V	3 Lead TO-263
SPX2700T3-5.0	2%	5.0V	3 Lead TO-263
SPX2700AT3-3.3	1%	3.3V	3 Lead TO-263
SPX2700AT3-5.0	1%	5.0V	3 Lead TO-263
SPX2700T5-3.3	2%	3.3V	5 Lead TO-263
SPX2700T5-5.0	2%	5.0V	5 Lead TO-263
SPX2700AT5-3.3	1%	3.3V	5 Lead TO-263
SPX2700AT5-5.0	1%	5.0V	5 Lead TO-263
SPX2700U3-3.3	2%	3.3V	3 Lead TO-220
SPX2700U3-5.0	2%	5.0V	3 Lead TO-220
SPX2700AU3-3.3	1%	3.3V	3 Lead TO-220
SPX2700AU3-5.0	1%	5.0V	3 Lead TO-220
SPX2700U5-3.3	2%	3.3V	5 Lead TO-220
SPX2700U5-5.0	2%	5.0V	5 Lead TO-220
SPX2700AU5-3.3	1%	3.3V	5 Lead TO-220
SPX2700AU5-5.0	1%	5.0V	5 Lead TO-220
SPX2701T3-3.3	2%	3.3V	3 Lead TO-263
SPX2701T3-5.0	2%	5.0V	3 Lead TO-263
SPX2701AT3-3.3	1%	3.3V	3 Lead TO-263
SPX2701AT3-5.0	1%	5.0V	3 Lead TO-263
SPX2701T5-3.3	2%	3.3V	5 Lead TO-263
SPX2701T5-5.0	2%	5.0V	5 Lead TO-263
SPX2701AT5-3.3	1%	3.3V	5 Lead TO-263
SPX2701AT5-5.0	1%	5.0V	5 Lead TO-263
SPX2701U3-3.3	2%	3.3V	3 Lead TO-220
SPX2701U3-5.0	2%	5.0V	3 Lead TO-220
SPX2701AU3-3.3	1%	3.3V	3 Lead TO-220
SPX2701AU3-5.0	1%	5.0V	3 Lead TO-220
SPX2701U5-3.3	2%	3.3V	5 Lead TO-220
SPX2701U5-5.0	2%	5.0V	5 Lead TO-220
SPX2701AU5-3.3	1%	3.0V	5 Lead TO-220
SPX2701AU5-5.0	1%	5.0V	5 Lead TO-220
SPX2702T3	2%	Adj	3 Lead TO-263
SPX2702AT3	1%	Adj	3 Lead TO-263
SPX2702T5	2%	Adj	5 Lead TO-263
SPX2702AT5	1%	Adj	5 Lead TO-263
SPX2702U3	2%	Adj	3 Lead TO-220
SPX2702AU3	1%	Adj	3 Lead TO-220
SPX2702U5	2%	Adj	5 Lead TO-220
SPX2702AU5	1%	Adj	5 Lead TO-220



SIGNAL PROCESSING EXCELLENCE

**Sipex Corporation**

**Headquarters and Main Offices:**  
22 Linnell Circle  
Billerica, MA 01821  
TEL: (978) 667-8700  
FAX: (978) 670-9001  
e-mail: [sales@sipex.com](mailto:sales@sipex.com)

233 South Hillview Drive  
Milpitas, CA 95035  
TEL: (408) 935-7600  
FAX: (408) 934-7500

Sipex Corporation reserves the right to make changes to any products described herein. Sipex does not assume any liability arising out of the application or use of any product or circuit described hereing; neither does it convey any license under its patent rights nor the rights of others.