



Micro Commercial Components



Micro Commercial Components
 20736 Marilla Street Chatsworth
 CA 91311
 Phone: (818) 701-4933
 Fax: (818) 701-4939

1SS196

150mW Switching Diodes

Features

- Low Leakage Current
- Surface Mount SOT-23 Package
- Epoxy meets UL 94 V-0 flammability rating
- Moisture Sensitivity Level 1
- Marking Code : G3

Maximum Ratings

Reverse Voltage	V_R	80V
Forward Current	I_F	100mA
Power Dissipation @ $T_A=25^\circ\text{C}$	P_D	150mW
Storage Temperature Range	T_{stg}	-55°C to $+150^\circ\text{C}$
Junction Temperature	T_j	150°C

Electrical Characteristics @ 25°C Unless Otherwise Specified

Reverse Voltage	V_R	80V	
Minimum Reverse Breakdown Voltage	$V_{(BR)}$	80V	$I_R=100\mu\text{A}$ $T_A = 25^\circ\text{C}$
Maximum Forward Voltage	V_F	1.2V	$T_A= 25^\circ\text{C}$ $I_F = 100\text{mA}$;
Maximum Reverse Voltage Leakage Current	I_R	0.5uA	$V_R=80\text{Volts}$ $T_A = 25^\circ\text{C}$
Maximum Diode Capacitance	C_D	3.0pF	Measured at $f=1.0\text{MHz}$, $V_R=0$
Maximum Reverse Recovery Time	t_{rr}	4.0ns	

SOT-23

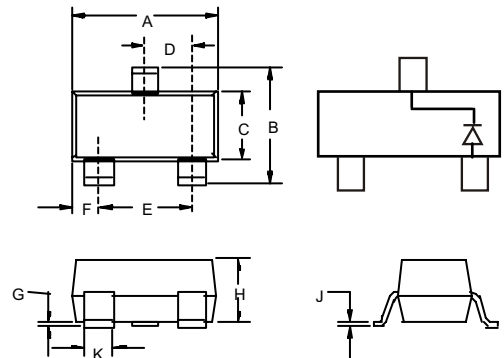

DIM	DIMENSIONS				NOTE
	INCHES		MM		
A	.110	.120	2.80	3.04	
B	.083	.098	2.10	2.64	
C	.047	.055	1.20	1.40	
D	.035	.041	.89	1.03	
E	.070	.081	1.78	2.05	
F	.018	.024	.45	.60	
G	.0005	.0039	.013	.100	
H	.035	.044	.89	1.12	
J	.003	.007	.085	.180	
K	.015	.020	.37	.51	

Suggested Solder Pad Layout

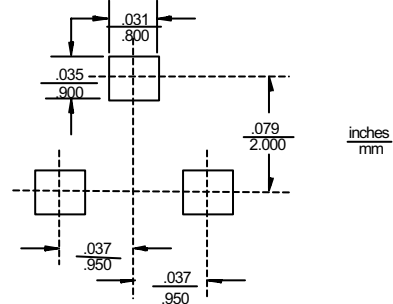

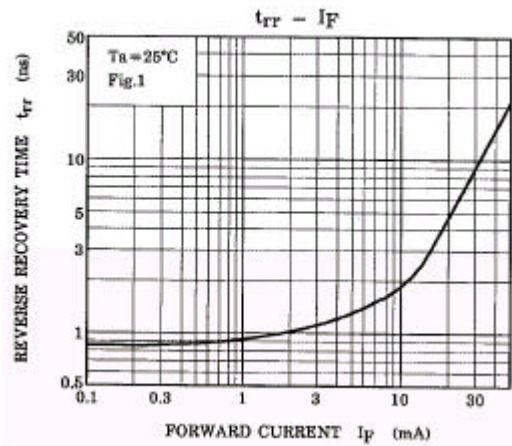
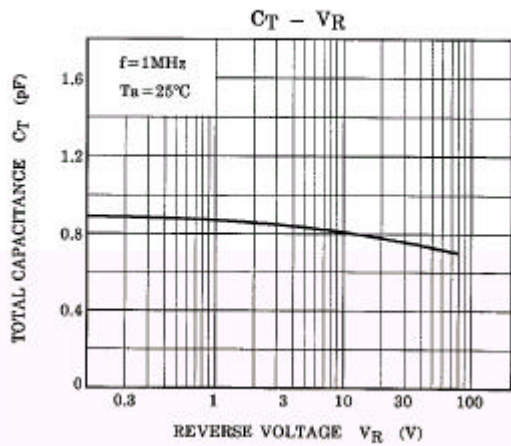
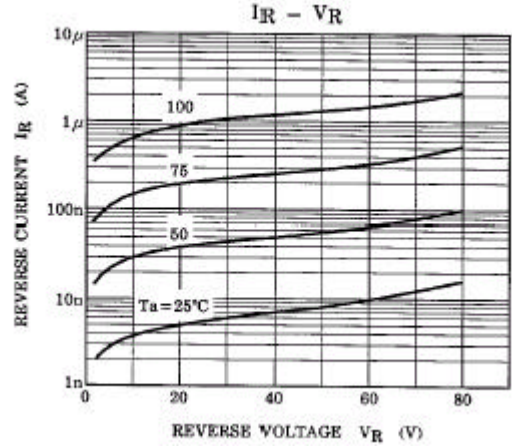
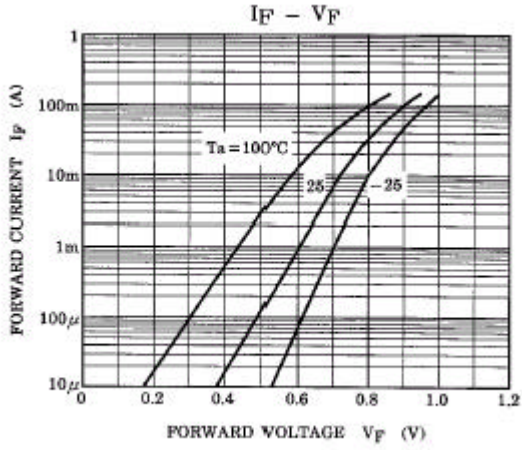
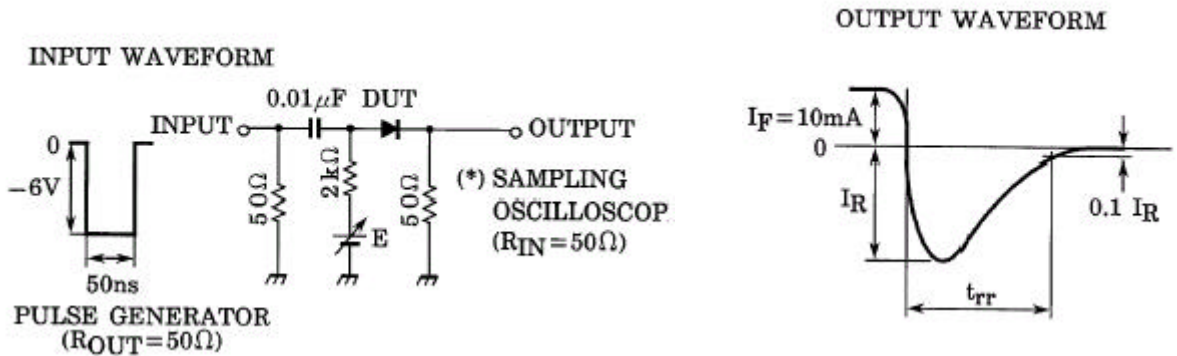

Fig.1 Reverse recovery time (t_{rr}) test circuit





Micro Commercial Components

Ordering Information :

Device	Packing
Part Number-TP	Tape&Reel: 3Kpcs/Reel

*****IMPORTANT NOTICE*****

Micro Commercial Components Corp. reserves the right to make changes without further notice to any product herein to make corrections, modifications , enhancements , improvements , or other changes . **Micro Commercial Components Corp .** does not assume any liability arising out of the application or use of any product described herein; neither does it convey any license under its patent rights ,nor the rights of others . The user of products in such applications shall assume all risks of such use and will agree to hold **Micro Commercial Components Corp .** and all the companies whose products are represented on our website, harmless against all damages.

*****LIFE SUPPORT*****

MCC's products are not authorized for use as critical components in life support devices or systems without the express written approval of Micro Commercial Components Corporation.

*****CUSTOMER AWARENESS*****

Counterfeiting of semiconductor parts is a growing problem in the industry. Micro Commercial Components (MCC) is taking strong measures to protect ourselves and our customers from the proliferation of counterfeit parts. MCC strongly encourages customers to purchase MCC parts either directly from MCC or from Authorized MCC Distributors who are listed by country on our web page cited below. Products customers buy either from MCC directly or from Authorized MCC Distributors are genuine parts, have full traceability, meet MCC's quality standards for handling and storage. **MCC will not provide any warranty coverage or other assistance for parts bought from Unauthorized Sources.** MCC is committed to combat this global problem and encourage our customers to do their part in stopping this practice by buying direct or from authorized distributors.