

**SMALL SIGNAL COMPLEMENTARY PRE-BIASED DUAL TRANSISTOR**
**Features**

- Epitaxial Planar Die Construction
- Built-In Biasing Resistors
- Surface Mount Package Suited for Automated Assembly
- **Totally Lead-Free & Fully RoHS Compliant (Notes 1 & 2)**
- **Halogen and Antimony-Free. “Green” Device (Note 3)**
- **For automotive applications requiring specific change control (i.e. parts qualified to AEC-Q100/101/200, PPAP capable, and manufactured in IATF 16949 certified facilities), please contact us or your local Diodes representative. <https://www.diodes.com/quality/product-definitions/>**

**Mechanical Data**

- Package: SOT363
- Package Material: Molded Plastic, “Green” Molding Compound; UL Flammability Classification Rating 94V-0
- Moisture Sensitivity: Level 1 per J-STD-020
- Terminals: Finish – Matte Tin Plated Leads, Solderable per MIL-STD-202, Method 208 ③
- Weight: 0.006 grams (Approximate)

Part Number	R1(NOM)	R2(NOM)
DCX124EU	22kΩ	22kΩ
DCX144EU	47kΩ	47kΩ
DCX114YU	10kΩ	47kΩ
DCX123JU	2.2kΩ	47kΩ
DCX114EU	10kΩ	10kΩ
DCX143EU	4.7kΩ	4.7kΩ
DCX143ZU	4.7kΩ	47kΩ
DCX115EU	100kΩ	100kΩ

Part Number	R1 Only
DCX143TU	4.7kΩ
DCX114TU	10kΩ

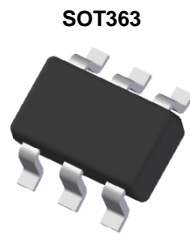

Top View

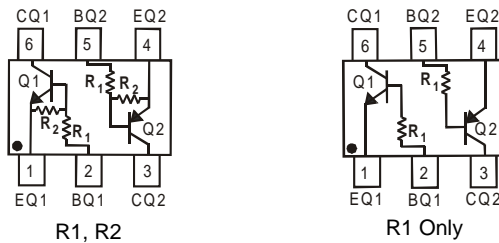

Device Schematic

**Ordering Information** (Notes 4, 5)

Product	Status	Compliance	Marking	Reel Size (inches)	Tape Width (mm)	Quantity per Reel
DCX124EU-7-F	Active	Standard	C17	7	8	3,000
DCX124EUQ-7-F	NRND (Use ACX124EUQ)	Automotive	C17	7	8	3,000
DCX124EUQ-13-F	NRND (Use ACX124EUQ)	Automotive	C17	13	8	10,000
DCX124EUQ-13R-F	NRND (Use ACX124EUQ)	Automotive	C17	13	8	10,000
DCX144EU-7-F	Active	Standard	C20	7	8	3,000
DCX144EU-7R-F	Active	Standard	C20	7	8	3,000
DCX144EUQ-7-F	Active	Automotive	C20	7	8	3,000
DCX144EUQ-7R-F	Active	Automotive	C20	7	8	3,000
DCX114YU-7-F	Active	Standard	C14	7	8	3,000
DCX114YU-7R-F	Active	Standard	C14	7	8	3,000
DCX114YUQ-7-F	NRND (Use ACX114YUQ)	Automotive	C14	7	8	3,000
DCX114YUQ-13-F	NRND (Use ACX114YUQ)	Automotive	C14	13	8	10,000
DCX114YUQ-13R-F	NRND (Use ACX114YUQ)	Automotive	C14	13	8	10,000
DCX123JU-7-F	Active	Standard	C06	7	8	3,000
DCX123JUQ-7-F	Active	Automotive	C06	7	8	3,000
DCX114EU-7-F	Active	Standard	C13	7	8	3,000
DCX114EU-13R-F	Active	Standard	C13	13	8	10,000

### Ordering Information (Notes 4, 5) (continued)

Product	Status	Compliance	Marking	Reel Size (inches)	Tape Width (mm)	Quantity per Reel
DCX114EUQ-7-F	NRND (Use ACX114EUQ)	Automotive	C13	7	8	3,000
DCX114EUQ-13-F	NRND (Use ACX114EUQ)	Automotive	C13	13	8	10,000
DCX114EUQ-13R-F	NRND (Use ACX114EUQ)	Automotive	C13	13	8	10,000
DCX143TU-7-F	Active	Standard	C07	7	8	3,000
DCX143EU-7-F	Active	Standard	C08	7	8	3,000
DCX114TU-7-F	Active	Standard	C12	7	8	3,000
DCX143ZU-7-F	Active	Standard	C02	7	8	3,000
DCX115EU-7-F	Active	Standard	C01	7	8	3,000

- Notes:
1. No purposely added lead. Fully EU Directive 2002/95/EC (RoHS), 2011/65/EU (RoHS 2) & 2015/863/EU (RoHS 3) compliant.
  2. See <https://www.diodes.com/quality/lead-free/> for more information about Diodes Incorporated's definitions of Halogen- and Antimony-free, "Green" and Lead-free.
  3. Halogen- and Antimony-free "Green" products are defined as those which contain <900ppm bromine, <900ppm chlorine (<1500ppm total Br + Cl) and <1000ppm antimony compounds.
  4. For packaging details, go to our website at <https://www.diodes.com/design/support/packaging/diodes-packaging/>.
  5. NRND = Not Recommended for New Design.

### Marking Information

SOT363

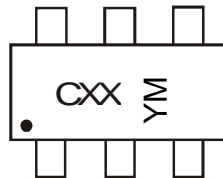

CXX = Product Type Marking Code  
 YM = Date Code Marking  
 Y or  $\bar{Y}$  = Year (ex: I = 2021)  
 M = Month (ex: D = December)

Date Code Key

<b>Year</b>	2020	2021	2022	2023	2024	2025	2026	2027	2028	2029	2030	2031
<b>Code</b>	H	I	J	K	L	M	N	O	P	R	S	T
<b>Month</b>	Jan	Feb	Mar	Apr	May	Jun	Jul	Aug	Sep	Oct	Nov	Dec
<b>Code</b>	1	2	3	4	5	6	7	8	9	O	N	D

**Absolute Maximum Ratings NPN Section (@ T<sub>A</sub> = +25°C, unless otherwise specified.)**

Characteristic		Symbol	Value	Unit
Supply Voltage <Pin: (6) to (1)>		V <sub>CC</sub>	50	V
Input Voltage <Pin: (2) to (1)>	DCX124EU	V <sub>IN</sub>	-10 to +40	V
	DCX144EU		-10 to +40	
	DCX114YU		-6 to +40	
	DCX123JU		-5 to +12	
	DCX114EU		-10 to +40	
	DCX143TU		-5V Max	
	DCX143EU		-10 to +30	
	DCX114TU		-5V Max	
Output Current	DCX143ZU	I <sub>O</sub>	-10 to +30	mA
	DCX115EU		-10 to +40	
	DCX124EU		30	
	DCX144EU		30	
	DCX114YU		70	
	DCX123JU		100	
	DCX114EU		50	
	DCX143TU		100	
Output Current	DCX143EU	I <sub>C (Max)</sub>	100	mA
	DCX114TU		100	
	DCX143ZU		100	
	DCX115EU		20	

**Absolute Maximum Ratings PNP Section (@ T<sub>A</sub> = +25°C, unless otherwise specified.)**

Characteristic		Symbol	Value	Unit
Supply Voltage <Pin: (4) to (3)>		V <sub>CC</sub>	50	V
Input Voltage <Pin: (5) to (4)>	DCX124EU	V <sub>IN</sub>	+10 to -40	V
	DCX144EU		+10 to -40	
	DCX114YU		+6 to -40	
	DCX123JU		+5 to -12	
	DCX114EU		+10 to -40	
	DCX143TU		+5V Max	
	DCX143EU		+10 to -30	
	DCX114TU		+5V Max	
Output Current	DCX143ZU	I <sub>O</sub>	+5 to -30	mA
	DCX115EU		+10 to -40	
	DCX124EU		-30	
	DCX144EU		-30	
	DCX114YU		-70	
	DCX123JU		-100	
	DCX114EU		-50	
	DCX143TU		-100	
Output Current	DCX143EU	I <sub>C (Max)</sub>	-100	mA
	DCX114TU		-100	
	DCX143ZU		-100	
	DCX115EU		-20	

**Thermal Characteristics (@ T<sub>A</sub> = +25°C, unless otherwise specified.)**

Characteristic	Symbol	Value	Unit
Power Dissipation (Notes 6, 7)	P <sub>D</sub>	200	mW
Thermal Resistance, Junction to Ambient Air (Note 6)	R <sub>θJA</sub>	625	°C/W
Operating and Storage Temperature Range	T <sub>J</sub> , T <sub>STG</sub>	-55 to +150	°C

Notes: 6. Mounted on FR-4 PC Board with minimum recommended pad layout.  
7. 150mW per element must not be exceeded.

**Thermal Characteristics** (@  $T_A = +25^\circ\text{C}$ , unless otherwise specified.)

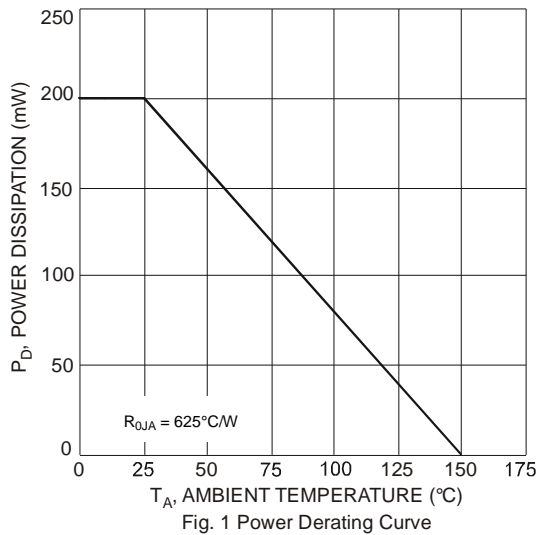

**Electrical Characteristics NPN Section** (@ T<sub>A</sub> = +25°C, unless otherwise specified.)

Characteristic		Symbol	Min	Typ	Max	Unit	Test Condition	
<b>R1 Only (DCX143TU &amp; DCX114TU)</b>								
Collector-Base Breakdown Voltage		BV <sub>CBO</sub>	50	—	—	V	I <sub>C</sub> = 50μA	
Collector-Emitter Breakdown Voltage		BV <sub>CEO</sub>	50	—	—	V	I <sub>C</sub> = 1mA	
Emitter-Base Breakdown Voltage		BV <sub>EBO</sub>	5	—	—	V	I <sub>E</sub> = 50μA	
Collector Cutoff Current		I <sub>CBO</sub>	—	—	0.5	μA	V <sub>CB</sub> = 50V	
Emitter Cutoff Current		I <sub>EBO</sub>	—	—	0.5	μA	V <sub>EB</sub> = 4V	
Collector-Emitter Saturation Voltage		V <sub>CE(sat)</sub>	—	—	0.3	V	I <sub>C</sub> /I <sub>B</sub> = 2.5mA / 0.25mA DCX143TU I <sub>C</sub> /I <sub>B</sub> = 1mA / 0.1mA DCX114TU	
DC Current Transfer Ratio		h <sub>FE</sub>	100	250	600	—	I <sub>C</sub> = 1mA, V <sub>CE</sub> = 5V	
Input Resistor (R <sub>1</sub> ) Tolerance		ΔR <sub>1</sub>	-30	—	+30	%	—	
Gain-Bandwidth Product		f <sub>T</sub>	—	250	—	MHz	V <sub>CE</sub> = 10V, I <sub>E</sub> = 5mA, f = 100MHz	
<b>R1/R2 Only</b>								
Input Voltage	DCX124EU	V <sub>I(off)</sub>	0.5	1.1	—	V	V <sub>CC</sub> = 5V, I <sub>O</sub> = 100μA	
	DCX144EU		0.5	1.1				
	DCX114YU		0.3	—				
	DCX123JU		0.5	—				
	DCX114EU		0.5	1.1				
	DCX143EU		0.5	1.16				
	DCX143ZU		0.5	—				
	DCX115EU		0.5	—				
	DCX124EU	V <sub>I(on)</sub>	—	1.9	3.0	V	V <sub>O</sub> = 0.3V, I <sub>O</sub> = 5mA	
	DCX144EU		—	1.9	3.0		V <sub>O</sub> = 0.3V, I <sub>O</sub> = 2mA	
	DCX114YU		—	—	1.4		V <sub>O</sub> = 0.3V, I <sub>O</sub> = 1mA	
	DCX123JU		—	—	1.1		V <sub>O</sub> = 0.3V, I <sub>O</sub> = 5mA	
	DCX114EU		—	1.9	3.0		V <sub>O</sub> = 0.3V, I <sub>O</sub> = 10mA	
	DCX143EU		—	1.99	3.0		V <sub>O</sub> = 0.3V, I <sub>O</sub> = 20mA	
	DCX143ZU		—	—	1.3		V <sub>O</sub> = 0.3V, I <sub>O</sub> = 5mA	
	DCX115EU		—	—	3		V <sub>O</sub> = 0.3V, I <sub>O</sub> = 1mA	
Output Voltage	DCX124EU	V <sub>O(on)</sub>	—	0.1	0.3	V	I <sub>O</sub> /I <sub>I</sub> = 10mA / 0.5mA	
	DCX144EU						I <sub>O</sub> /I <sub>I</sub> = 10mA / 0.5mA	
	DCX114YU						I <sub>O</sub> /I <sub>I</sub> = 5mA / 0.25mA	
	DCX123JU						I <sub>O</sub> /I <sub>I</sub> = 5mA / 0.25mA	
	DCX114EU						I <sub>O</sub> /I <sub>I</sub> = 10mA / 0.5mA	
	DCX143EU						I <sub>O</sub> /I <sub>I</sub> = 10mA / 0.5mA	
	DCX143ZU						I <sub>O</sub> /I <sub>I</sub> = 5mA / 0.25mA	
	DCX115EU						I <sub>O</sub> /I <sub>I</sub> = 10mA / 0.5mA	
Input Current	DCX124EU	I <sub>I</sub>	—	—	—	mA	V <sub>I</sub> = 5V	
	DCX144EU							0.36
	DCX114YU							0.18
	DCX123JU							0.88
	DCX114EU							3.6
	DCX143EU							0.88
	DCX143ZU							0.88
	DCX115EU							1.8
Output Current	I <sub>O(off)</sub>	—	—	0.5	μA	V <sub>CC</sub> = 50V, V <sub>I</sub> = 0V		
DC Current Gain	DCX124EU	G <sub>I</sub>	—	—	—	—	V <sub>O</sub> = 5V, I <sub>O</sub> = 5mA	
	DCX124EUQ						56	V <sub>O</sub> = 5V, I <sub>O</sub> = 5mA
	DCX144EU						60	V <sub>O</sub> = 5V, I <sub>O</sub> = 5mA
	DCX114YU						68	V <sub>O</sub> = 5V, I <sub>O</sub> = 5mA
	DCX114YUQ						68	V <sub>O</sub> = 5V, I <sub>O</sub> = 10mA
	DCX123JU						80	V <sub>O</sub> = 5V, I <sub>O</sub> = 10mA
	DCX114EU						80	V <sub>O</sub> = 5V, I <sub>O</sub> = 10mA
	DCX143EU						30	V <sub>O</sub> = 5V, I <sub>O</sub> = 5mA
	DCX143ZU						50	V <sub>O</sub> = 5V, I <sub>O</sub> = 10mA
	DCX115EU						80	V <sub>O</sub> = 5V, I <sub>O</sub> = 10mA
DCX115EU	82	V <sub>O</sub> = 5V, I <sub>O</sub> = 5mA						
Input Resistor (R <sub>1</sub> ) Tolerance	ΔR <sub>1</sub>	-30	—	+30	%	—		
Resistance Ratio Tolerance	ΔR <sub>2</sub> /R <sub>1</sub>	-20	—	+20	%	—		
Gain-Bandwidth Product	f <sub>T</sub>	—	250	—	—	MHz	V <sub>CE</sub> = 10V, I <sub>E</sub> = 5mA, f = 100MHz	

**Electrical Characteristics PNP Section** (@ T<sub>A</sub> = +25°C, unless otherwise specified.)

Characteristic		Symbol	Min	Typ	Max	Unit	Test Condition	
<b>R1 Only (DCX143TU &amp; DCX114TU)</b>								
Collector-Base Breakdown Voltage		BV <sub>CBO</sub>	-50	—	—	V	I <sub>C</sub> = -50μA	
Collector-Emitter Breakdown Voltage		BV <sub>CEO</sub>	-50	—	—	V	I <sub>C</sub> = -1mA	
Emitter-Base Breakdown Voltage		BV <sub>EBO</sub>	-5	—	—	V	I <sub>E</sub> = -50μA	
Collector Cutoff Current		I <sub>CBO</sub>	—	—	-0.5	μA	V <sub>CB</sub> = -50V	
Emitter Cutoff Current		I <sub>EBO</sub>	—	—	-0.5	μA	V <sub>EB</sub> = -4V	
Collector-Emitter Saturation Voltage		V <sub>CE(sat)</sub>	—	—	-0.3	V	I <sub>C</sub> /I <sub>B</sub> = 2.5mA / 0.25mA DCX143TU I <sub>C</sub> /I <sub>B</sub> = 1mA / 0.1mA DCX114TU	
DC Current Transfer Ratio		h <sub>FE</sub>	100	250	600	—	I <sub>C</sub> = -1mA, V <sub>CE</sub> = -5V	
Input Resistor (R <sub>1</sub> ) Tolerance		ΔR <sub>1</sub>	-30	—	+30	%	—	
Gain-Bandwidth Product		f <sub>T</sub>	—	250	—	MHz	V <sub>CE</sub> = -10V, I <sub>E</sub> = -5mA, f = 100MHz	
<b>R1/R2 Only</b>								
Input Voltage	DCX124EU	V <sub>I(off)</sub>	-0.5	-1.1	—	V	V <sub>CC</sub> = -5V, I <sub>O</sub> = -100μA	
	DCX144EU		-0.5	-1.1				
	DCX114YU		-0.3	—				
	DCX123JU		-0.5	—				
	DCX114EU		-0.5	-1.1				
	DCX143EU		-0.5	-1.16				
	DCX143ZU		-0.5	—				
	DCX115EU		-0.5	—				
	DCX124EU	V <sub>I(on)</sub>	—	-1.9	-3.0	V	V <sub>O</sub> = -0.3V, I <sub>O</sub> = -5mA	
	DCX144EU		—	-1.9	-3.0		V <sub>O</sub> = -0.3V, I <sub>O</sub> = -2mA	
	DCX114YU		—	—	-1.4		V <sub>O</sub> = -0.3V, I <sub>O</sub> = -1mA	
	DCX123JU		—	—	-1.1		V <sub>O</sub> = -0.3V, I <sub>O</sub> = -5mA	
	DCX114EU		—	-1.9	-3.0		V <sub>O</sub> = -0.3V, I <sub>O</sub> = -10mA	
	DCX143EU		—	-2.5	-3.0		V <sub>O</sub> = -0.3V, I <sub>O</sub> = -20mA	
	DCX143ZU		—	—	-1.3		V <sub>O</sub> = -0.3V, I <sub>O</sub> = -5mA	
	DCX115EU		—	—	-3		V <sub>O</sub> = -0.3V, I <sub>O</sub> = -1mA	
	Output Voltage		DCX124EU	V <sub>O(on)</sub>	—		-0.1	-0.3
DCX144EU		I <sub>O</sub> /I <sub>I</sub> = -10mA / -0.5mA						
DCX114YU		I <sub>O</sub> /I <sub>I</sub> = -5mA / -0.25mA						
DCX123JU		I <sub>O</sub> /I <sub>I</sub> = -5mA / -0.25mA						
DCX114EU		I <sub>O</sub> /I <sub>I</sub> = -10mA / -0.5mA						
DCX143EU		I <sub>O</sub> /I <sub>I</sub> = -10mA / -0.5mA						
DCX143ZU		I <sub>O</sub> /I <sub>I</sub> = -5mA / -0.25mA						
DCX115EU	I <sub>O</sub> /I <sub>I</sub> = -10mA / -0.5mA							
Input Current	DCX124EU	I <sub>I</sub>	—	—	-0.36	mA	V <sub>I</sub> = -5V	
	DCX144EU				-0.18			
	DCX114YU				-0.88			
	DCX123JU				-3.6			
	DCX114EU				-0.88			
	DCX143EU				-0.88			
	DCX143ZU				-1.8			
	DCX115EU				-0.15			
Output Current		I <sub>O(off)</sub>	—	—	-0.5	μA	V <sub>CC</sub> = -50V, V <sub>I</sub> = 0V	
DC Current Gain	DCX124EU	G <sub>I</sub>	56	—	—	—	V <sub>O</sub> = -5V, I <sub>O</sub> = -5mA	
	DCX124EUQ						60	V <sub>O</sub> = -5V, I <sub>O</sub> = -5mA
	DCX144EU						68	V <sub>O</sub> = -5V, I <sub>O</sub> = -5mA
	DCX114YU						68	V <sub>O</sub> = -5V, I <sub>O</sub> = -10mA
	DCX114YUQ						80	V <sub>O</sub> = -5V, I <sub>O</sub> = -10mA
	DCX123JU						80	V <sub>O</sub> = -5V, I <sub>O</sub> = -10mA
	DCX114EU						30	V <sub>O</sub> = -5V, I <sub>O</sub> = -5mA
	DCX143EU						40	V <sub>O</sub> = -5V, I <sub>O</sub> = -10mA
	DCX143ZU						80	V <sub>O</sub> = -5V, I <sub>O</sub> = -10mA
DCX115EU	82	V <sub>O</sub> = -5V, I <sub>O</sub> = -5mA						
Input Resistor (R <sub>1</sub> ) Tolerance		ΔR <sub>1</sub>	-30	—	+30	%	—	
Resistance Ratio Tolerance		ΔR <sub>2</sub> /R <sub>1</sub>	-20	—	+20	%	—	
Gain-Bandwidth Product		f <sub>T</sub>	—	250	—	MHz	V <sub>CE</sub> = -10V, I <sub>E</sub> = -5mA, f = 100MHz	

**Typical Curves – DCX123JU PNP Section (@  $T_A = +25^\circ\text{C}$ , unless otherwise specified.)**

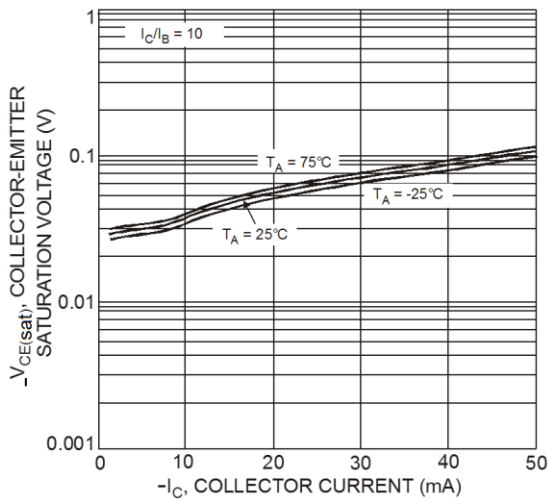

Fig. 24 Typical  $V_{CE(sat)}$  vs.  $I_C$

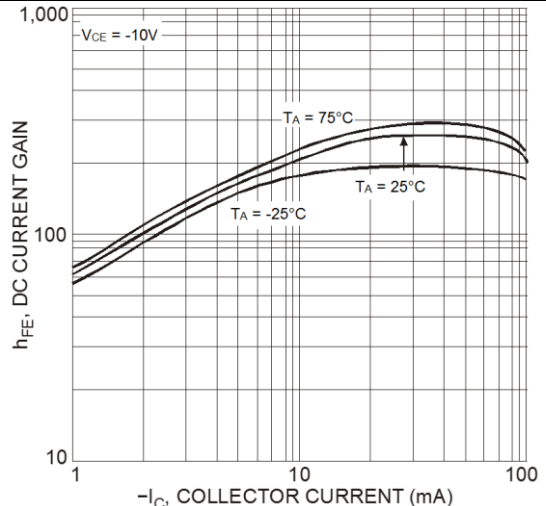

Fig. 3 Typical DC Current Gain

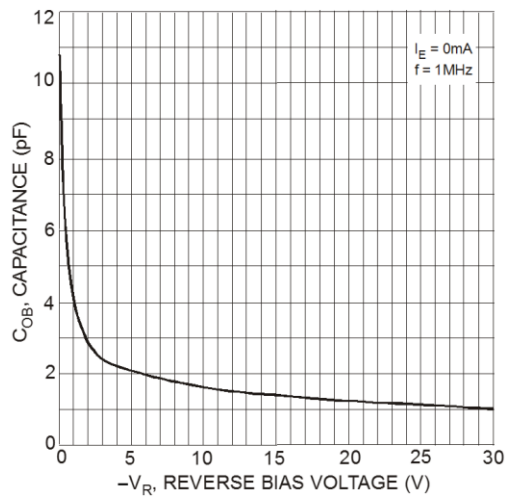

Fig. 4 Typical Output Capacitance

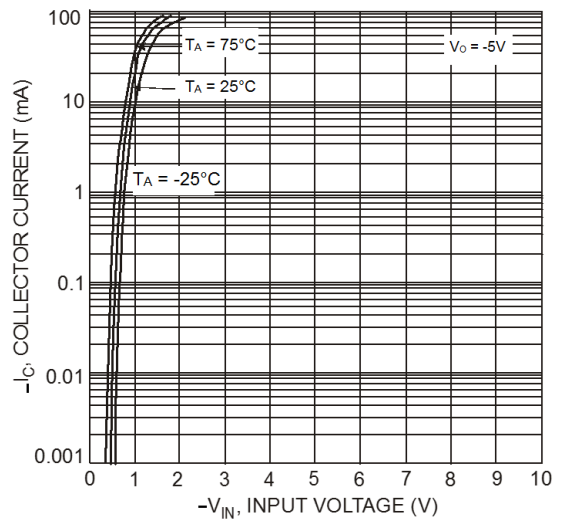

Fig. 5 Typical Collector Current vs. Input Voltage

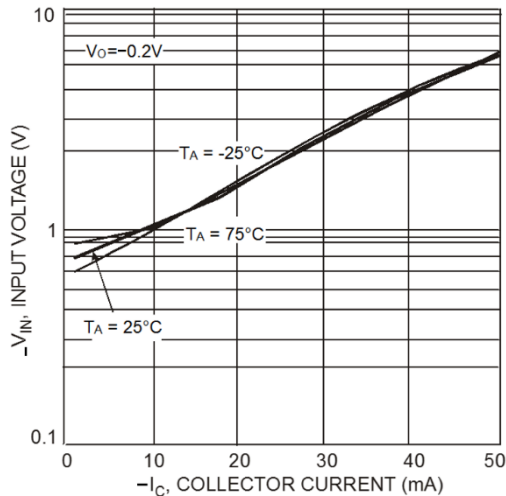
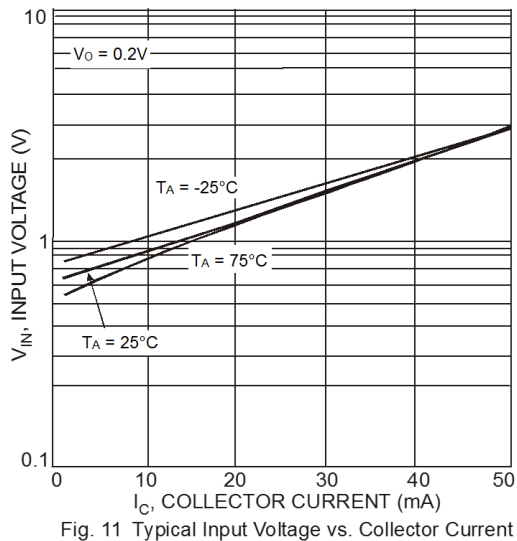
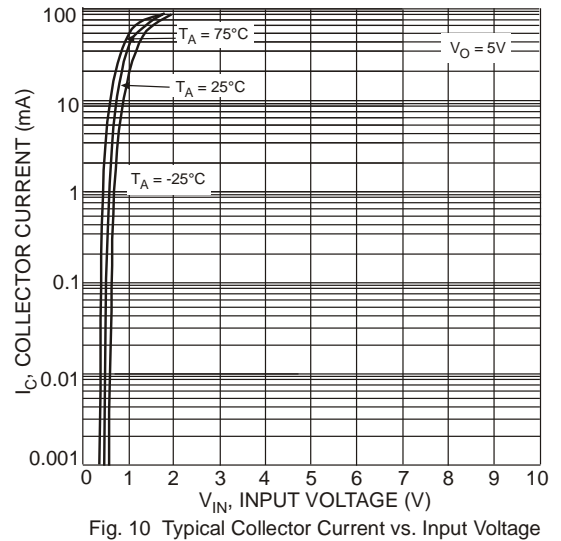
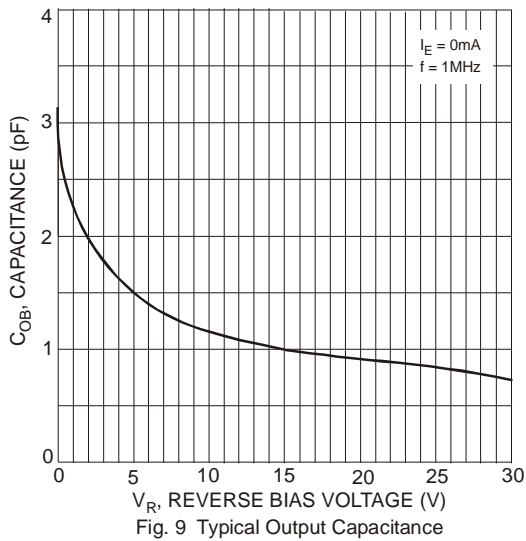
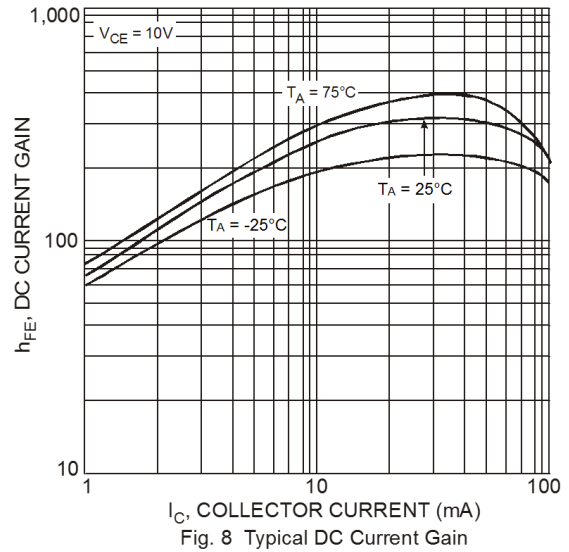
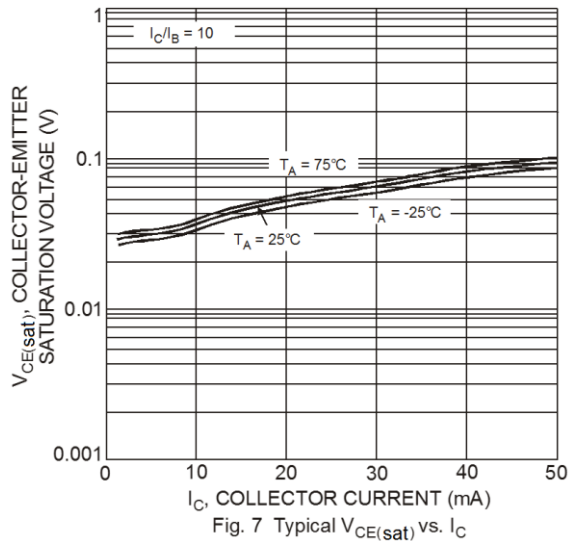

Fig. 6 Typical Input Voltage vs. Collector Current

**Typical Curves – DCX123JU NPN Section (@  $T_A = +25^\circ\text{C}$ , unless otherwise specified.)**





**Typical Curves – DCX143EU PNP Section** (@  $T_A = +25^\circ\text{C}$ , unless otherwise specified.)

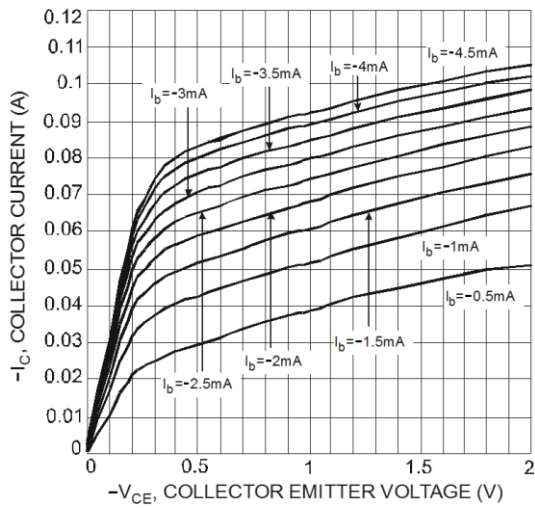

Fig. 12 Typical  $V_{CE}$  vs.  $I_C$

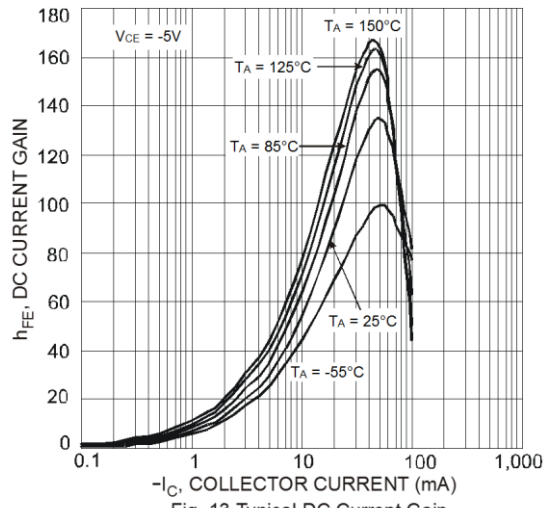

Fig. 13 Typical DC Current Gain

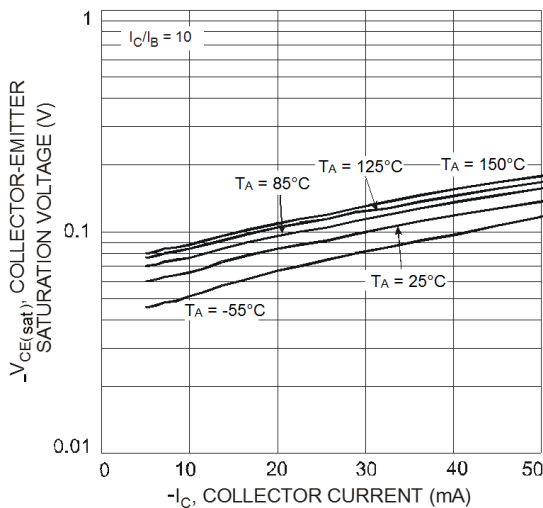

Fig. 14 Typical  $V_{CE(sat)}$  vs.  $I_C$

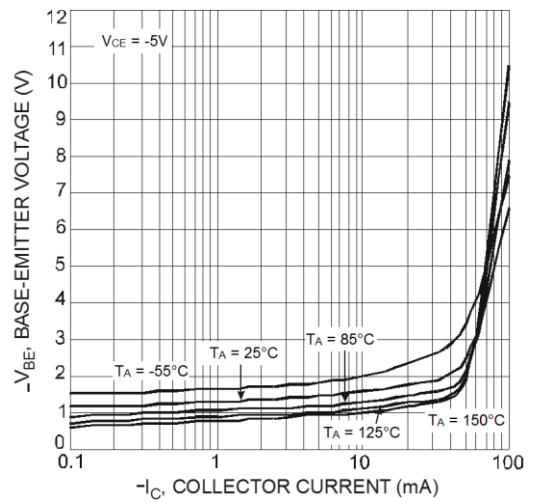

Fig. 15 Typical  $V_{BE}$  vs.  $I_C$

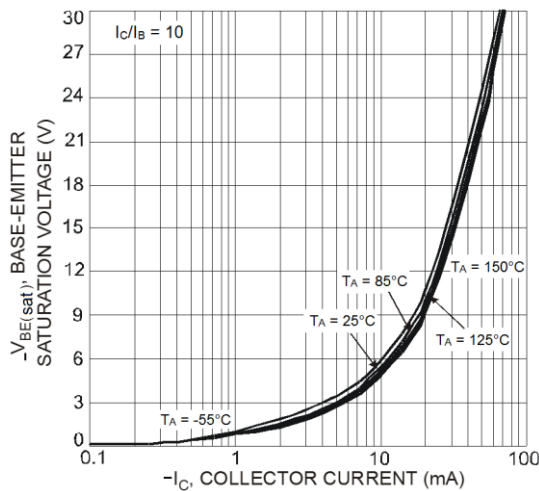

Fig. 16 Typical  $V_{BE(sat)}$  vs.  $I_C$

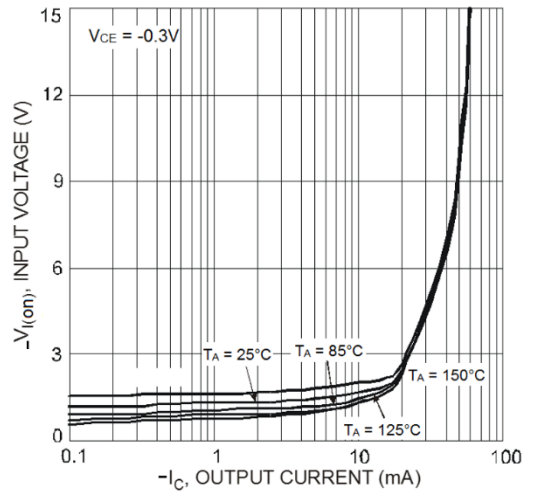
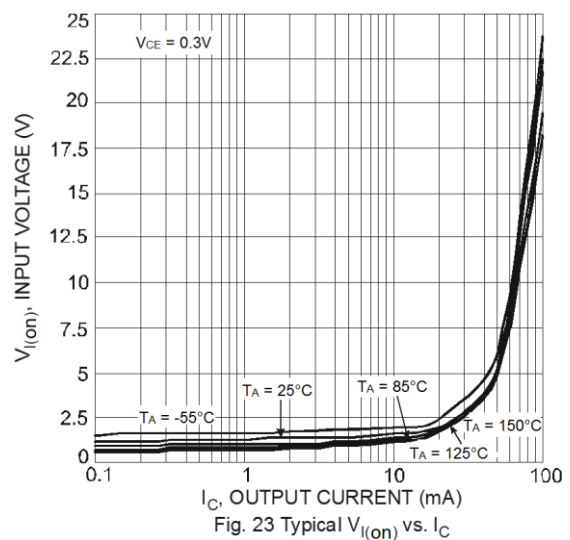
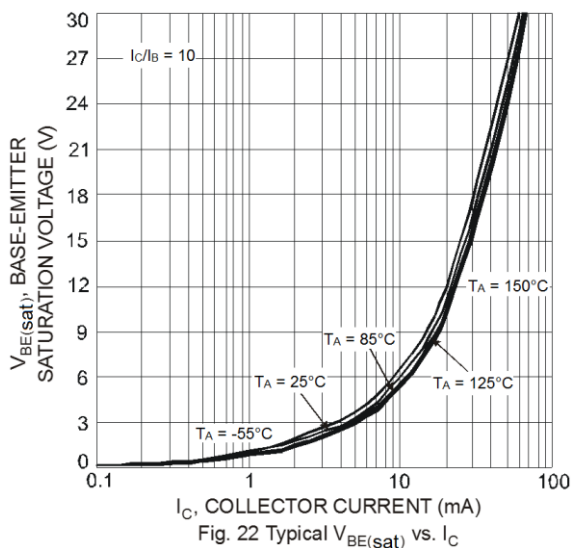
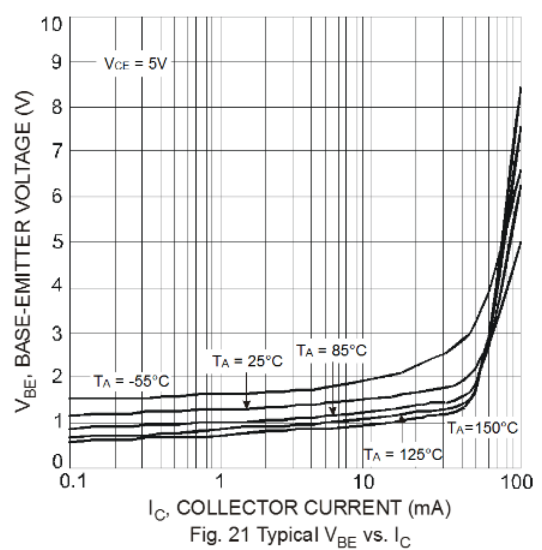
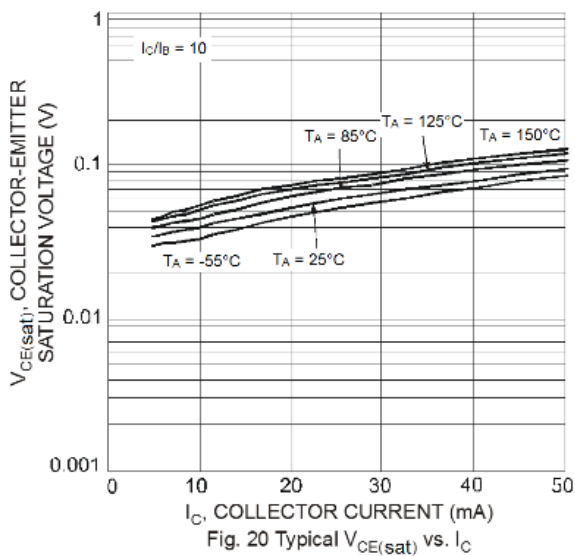
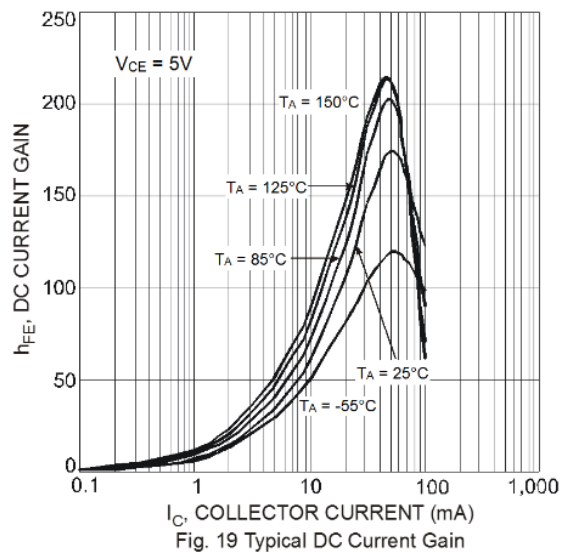
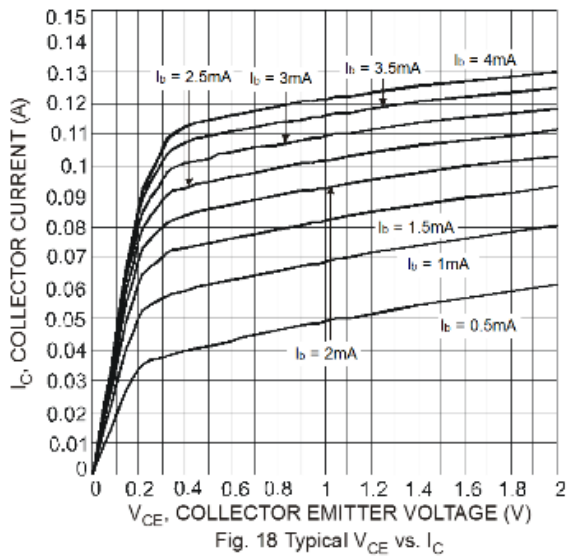
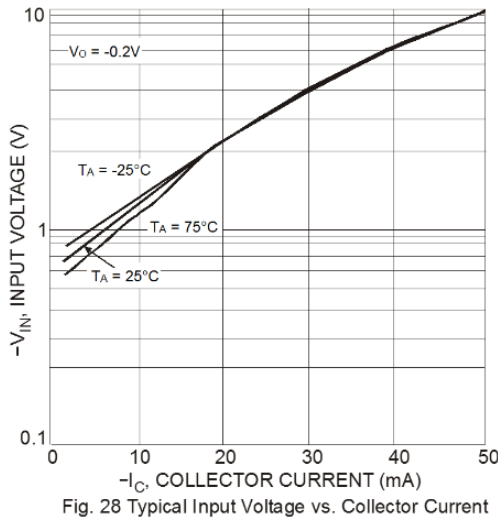
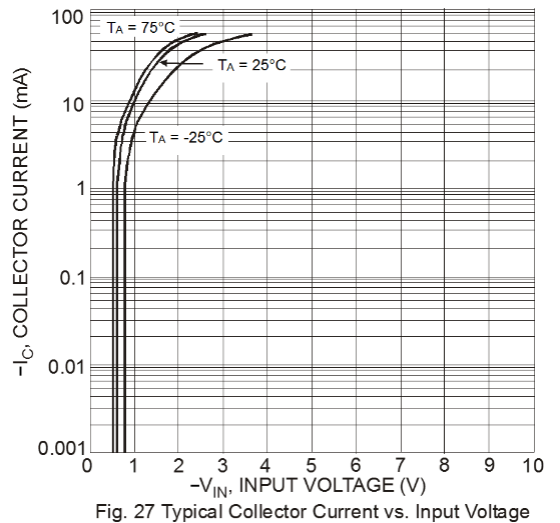
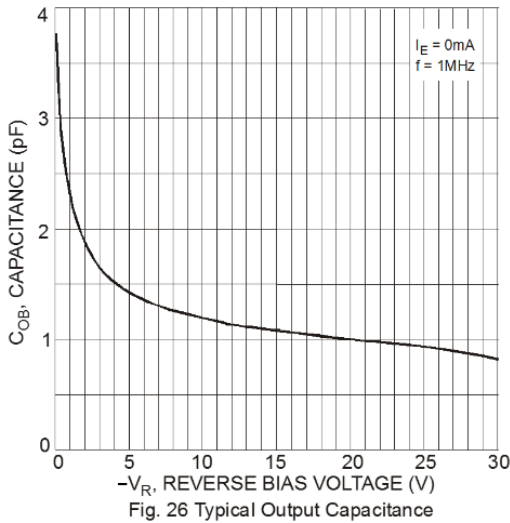
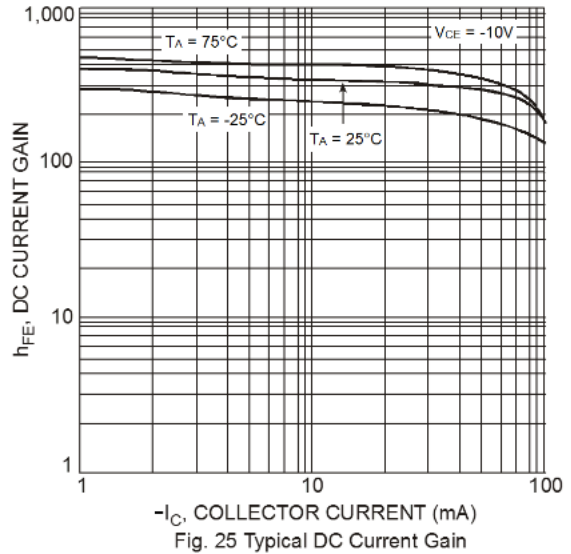
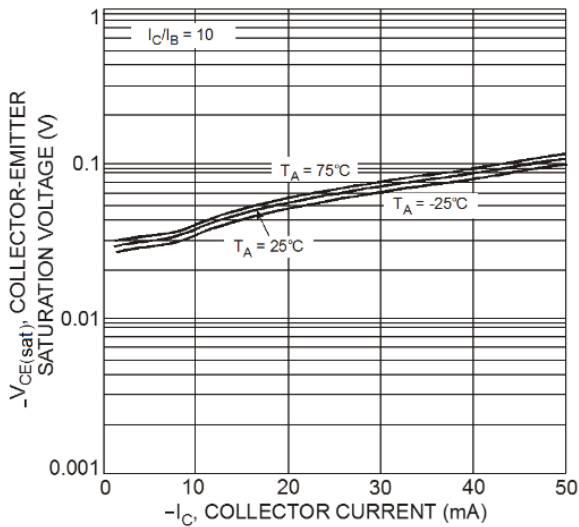

Fig. 17 Typical  $V_{I(on)}$  vs.  $I_C$

**Typical Curves – DCX143EU NPN Section** (@  $T_A = +25^\circ\text{C}$ , unless otherwise specified.)



**Typical Curves – DCX114TU PNP Section (@  $T_A = +25^\circ\text{C}$ , unless otherwise specified.)**



**Typical Curves – DCX114TU NPN Section** (@  $T_A = +25^\circ\text{C}$ , unless otherwise specified.)

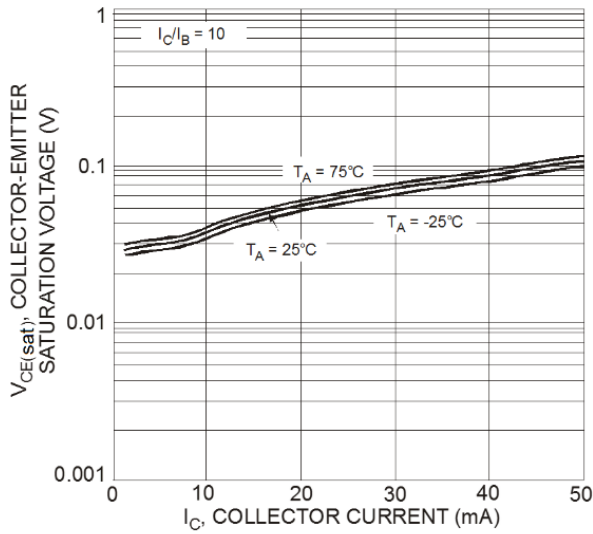

Fig. 29 Typical  $V_{CE(sat)}$  vs.  $I_C$

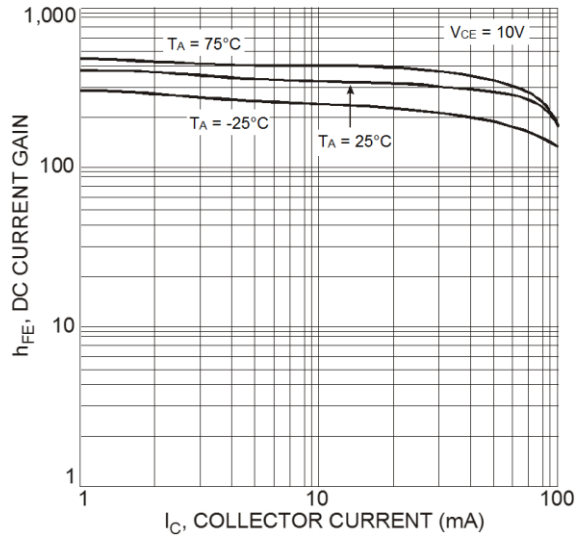

Fig. 30 Typical DC Current Gain

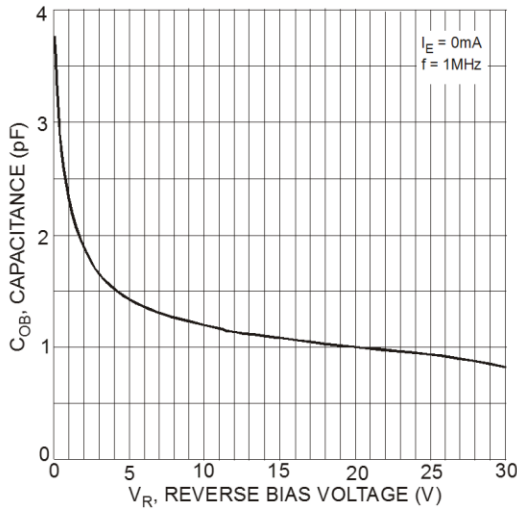

Fig. 31 Typical Output Capacitance

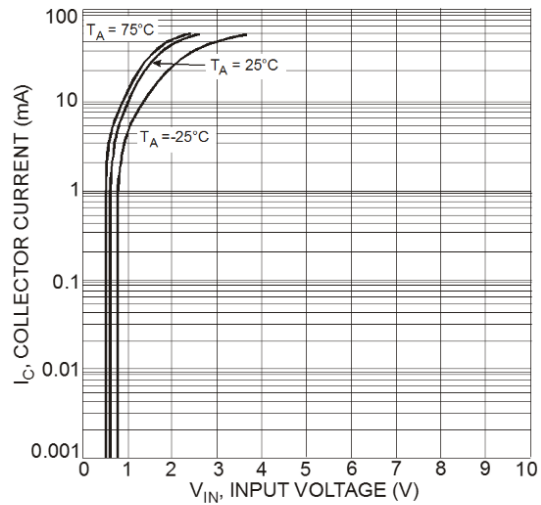

Fig. 32 Typical Collector Current vs. Input Voltage

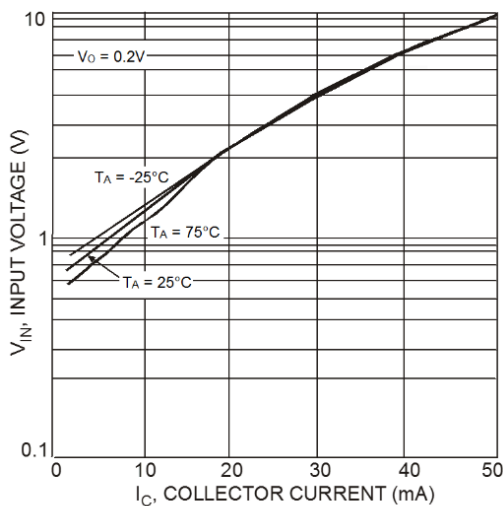
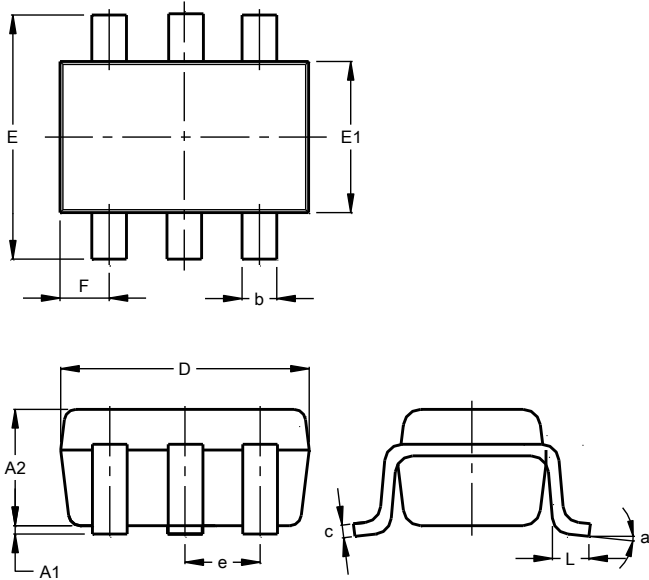

Fig. 33 Typical Input Voltage vs. Collector Current

**Package Outline Dimensions**

Please see <http://www.diodes.com/package-outlines.html> for the latest version.

**SOT363**



SOT363			
Dim	Min	Max	Typ
A1	0.00	0.10	0.05
A2	0.90	1.00	0.95
b	0.10	0.30	0.25
c	0.10	0.22	0.11
D	1.80	2.20	2.15
E	2.00	2.20	2.10
E1	1.15	1.35	1.30
e	0.650 BSC		
F	0.40	0.45	0.425
L	0.25	0.40	0.30
a	0°	8°	--
<b>All Dimensions in mm</b>			

**Suggested Pad Layout**

Please see <http://www.diodes.com/package-outlines.html> for the latest version.

**SOT363**

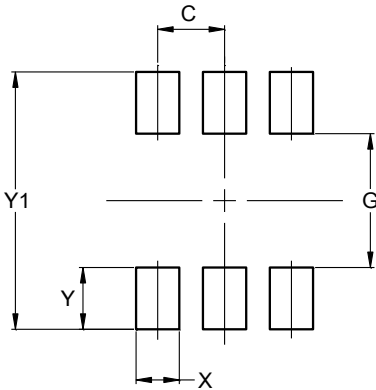

Dimensions	Value (in mm)
C	0.650
G	1.300
X	0.420
Y	0.600
Y1	2.500

**IMPORTANT NOTICE**

1. DIODES INCORPORATED AND ITS SUBSIDIARIES (“DIODES”) MAKE NO WARRANTY OF ANY KIND, EXPRESS OR IMPLIED, WITH REGARDS TO ANY INFORMATION CONTAINED IN THIS DOCUMENT, INCLUDING, BUT NOT LIMITED TO, THE IMPLIED WARRANTIES OF MERCHANTABILITY, FITNESS FOR A PARTICULAR PURPOSE OR NON-INFRINGEMENT OF THIRD PARTY INTELLECTUAL PROPERTY RIGHTS (AND THEIR EQUIVALENTS UNDER THE LAWS OF ANY JURISDICTION).
2. The Information contained herein is for informational purpose only and is provided only to illustrate the operation of Diodes products described herein and application examples. Diodes does not assume any liability arising out of the application or use of this document or any product described herein. This document is intended for skilled and technically trained engineering customers and users who design with Diodes products. Diodes products may be used to facilitate safety-related applications; however, in all instances customers and users are responsible for (a) selecting the appropriate Diodes products for their applications, (b) evaluating the suitability of the Diodes products for their intended applications, (c) ensuring their applications, which incorporate Diodes products, comply the applicable legal and regulatory requirements as well as safety and functional-safety related standards, and (d) ensuring they design with appropriate safeguards (including testing, validation, quality control techniques, redundancy, malfunction prevention, and appropriate treatment for aging degradation) to minimize the risks associated with their applications.
3. Diodes assumes no liability for any application-related information, support, assistance or feedback that may be provided by Diodes from time to time. Any customer or user of this document or products described herein will assume all risks and liabilities associated with such use, and will hold Diodes and all companies whose products are represented herein or on Diodes’ websites, harmless against all damages and liabilities.
4. Products described herein may be covered by one or more United States, international or foreign patents and pending patent applications. Product names and markings noted herein may also be covered by one or more United States, international or foreign trademarks and trademark applications. Diodes does not convey any license under any of its intellectual property rights or the rights of any third parties (including third parties whose products and services may be described in this document or on Diodes’ website) under this document.
5. Diodes products are provided subject to Diodes’ Standard Terms and Conditions of Sale (<https://www.diodes.com/about/company/terms-and-conditions/terms-and-conditions-of-sales/>) or other applicable terms. This document does not alter or expand the applicable warranties provided by Diodes. Diodes does not warrant or accept any liability whatsoever in respect of any products purchased through unauthorized sales channel.
6. Diodes products and technology may not be used for or incorporated into any products or systems whose manufacture, use or sale is prohibited under any applicable laws and regulations. Should customers or users use Diodes products in contravention of any applicable laws or regulations, or for any unintended or unauthorized application, customers and users will (a) be solely responsible for any damages, losses or penalties arising in connection therewith or as a result thereof, and (b) indemnify and hold Diodes and its representatives and agents harmless against any and all claims, damages, expenses, and attorney fees arising out of, directly or indirectly, any claim relating to any noncompliance with the applicable laws and regulations, as well as any unintended or unauthorized application.
7. While efforts have been made to ensure the information contained in this document is accurate, complete and current, it may contain technical inaccuracies, omissions and typographical errors. Diodes does not warrant that information contained in this document is error-free and Diodes is under no obligation to update or otherwise correct this information. Notwithstanding the foregoing, Diodes reserves the right to make modifications, enhancements, improvements, corrections or other changes without further notice to this document and any product described herein. This document is written in English but may be translated into multiple languages for reference. Only the English version of this document is the final and determinative format released by Diodes.
8. Any unauthorized copying, modification, distribution, transmission, display or other use of this document (or any portion hereof) is prohibited. Diodes assumes no responsibility for any losses incurred by the customers or users or any third parties arising from any such unauthorized use.

Copyright © 2021 Diodes Incorporated

[www.diodes.com](http://www.diodes.com)